

High Power Thin Film Wraparound Chip Resistor AEC-Q200 Qualified



LINKS TO ADDITIONAL RESOURCES



PHPA series chip resistors incorporate the self passivated enhanced tantalum nitride film to give superior moisture resistance, ESD, voltage coefficient, and resistance stability performance. They are designed with enlarged backside terminations to reduce the thermal resistance between the topside resistor layer and the solder joint on the end user's circuit board.

Actual power handling capability is limited by the end user mounting process. As with any high power chip resistor the ability to remove the generated heat is critical to the overall performance of the device.

CONSTRUCTION

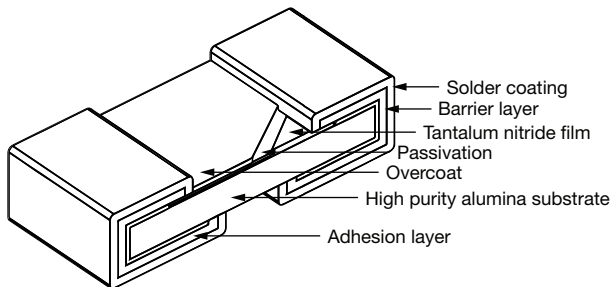

FEATURES

- AEC-Q200 qualified
- ESD rating 5A (HBM)
- Moisture resistant
- High purity ceramic substrate
- Power rating to 2.5 W
- Resistance range 10 Ω to 30.1 kΩ
- Resistor tolerance to ± 0.1 %
- TCR to ± 25 ppm/°C
- Flame resistant UL 94 V-0
- Material categorization: for definitions of compliance please see www.vishay.com/doc?99912



RoHS
COMPLIANT
HALOGEN
FREE

APPLICATIONS

- Power supplies
- Power switching
- Braking system
- Test and measurement equipment
- Motor deflection circuits

TYPICAL PERFORMANCE

	ABSOLUTE
TCR	25
TOL.	0.1

STANDARD ELECTRICAL SPECIFICATIONS		
TEST	SPECIFICATIONS	CONDITIONS
Material	Tantalum nitride	-
Resistance Range	10 Ω to 30.1 kΩ	-
TCR: Absolute	25 ppm/°C, 50 ppm/°C, and 100 ppm/°C	-55 °C to +155 °C
Tolerance: Absolute	± 0.1 % to ± 5 %	+25 °C
Power Rating: Resistor	1 W to 2.5 W ⁽¹⁾	Maximum at +70 °C
Stability: Absolute	ΔR 0.50 %	4000 h at +70 °C
Stability: Ratio	Not applicable	-
Voltage Coefficient	< 0.1 ppm/V	-
Working Voltage	200 V	-
Operating Temperature Range	-55 °C to +155 °C	-
Storage Temperature Range	-55 °C to +155 °C	-
Noise	< -30 dB	-
Shelf Life Stability: Absolute	± 0.01 %	1 year at +25 °C

Note

⁽¹⁾ Dependent on component mounting by user

COMPONENT RATINGS			
CASE SIZE	POWER RATING (mW)	WORKING VOLTAGE (V)	RESISTANCE RANGE (Ω)
1206	1000 ⁽¹⁾	200	12 to 30.1K
2512	2500 ⁽¹⁾	200	10 to 30.1K

Note

⁽¹⁾ Dependent on component mounting by user

ENVIRONMENTAL TESTS (Vishay Performance vs. AEC-Q200 Requirements)				
ENVIRONMENTAL TEST		CONDITIONS	TEST LIMITS	TYPICAL VISHAY PERFORMANCE
Resistance Temperature Characteristic		-55 °C to +155 °C	± 25 ppm/°C	+11.5 ppm/°C
Maximum Ambient Temperature at Rated Wattage		See Derating Curve		
Maximum Ambient Temperature at Power Derating		See Derating Curve		
High Temperature Exposure	ΔR	MIL-STD-202, method 108, 1000 h at 155 °C	± 0.2 %	+0.013 %
Temperature Cycling	ΔR	JESD22, JA-104, 1000 cycles, -55 °C to 155 °C	± 0.25 %	+0.006 %
Biased Humidity	ΔR	MIL-STD-202, 103, 1000 h at 85 °C, 85 % RH, 10 % power	± 1.0 %	+0.025 %
Life	ΔR	MIL-STD-202, 108, 2000 h at 70 °C, 100 % power	± 0.5 %	+0.060 %
Mechanical Shock	ΔR	MIL-STD-202, 213, condition C	± 0.25 %	0.000 %
Vibration	ΔR	MIL-STD-202, 204, 10 Hz to 2 kHz	± 0.25 %	0.000 %
Resistance to Soldering Heat	ΔR	MIL-STD-202, 210, condition D	± 0.25 %	+0.006 %
Electrostatic Discharge	ΔR	AEC-Q200-002 > 8 kV	± 1.0 %	-0.098 %
Solderability	Visual	J-STD-002, method B and B1	95 %	Acceptable
Terminal Strength	ΔR	AEC-Q200-006 at 1 kg for 60 s	± 1.0 %	0.000
Flame Retardance	Visual	AEC-Q200-001, para 4.0		Acceptable

Note

- Typical Vishay performance based on the data median

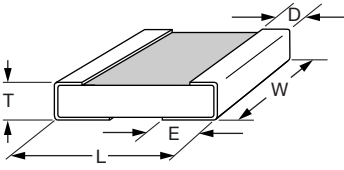
DIMENSIONS in inches					
					
CASE SIZE	LENGTH	WIDTH W (± 0.005)	THICKNESS MIN. / MAX.	TOP PAD D (± 0.005)	BOTTOM PAD E (± 0.005)
1206	0.126 \pm 0.008	0.063	0.015 / 0.020	0.020	0.040
2512	0.259 + 0.009/- 0.015	0.124	0.015 / 0.020	0.020	0.050

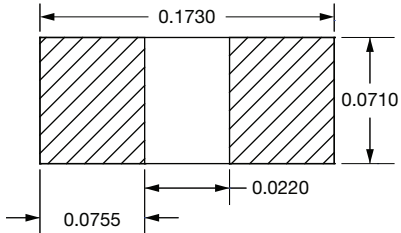
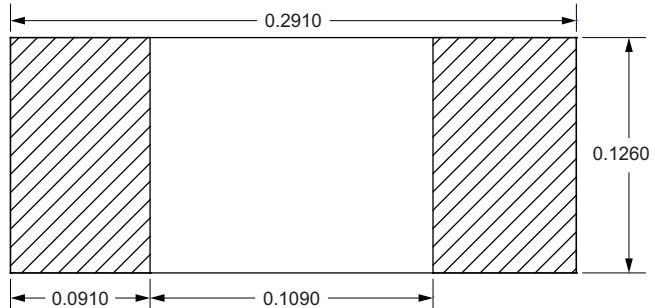
LAND PATTERN DIMENSIONS in inches	
1206 Land Pattern 	2512 Land Pattern 



STANDARD MATERIAL SPECIFICATIONS	
Resistive Element	Tantalum nitride
Substrate Material	Alumina (Al ₂ O ₃)
Terminations (Lead (Pb)-Free)	Tin solder plate over nickel barrier

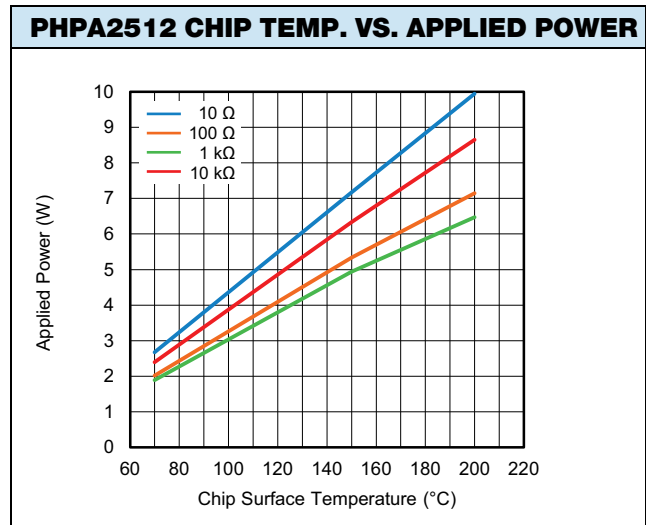
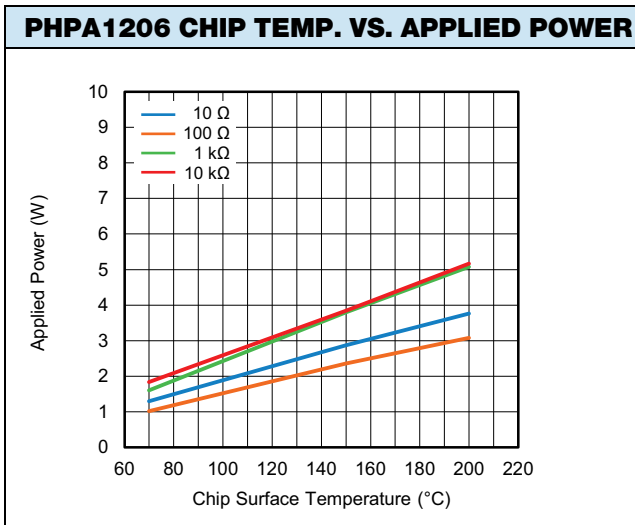
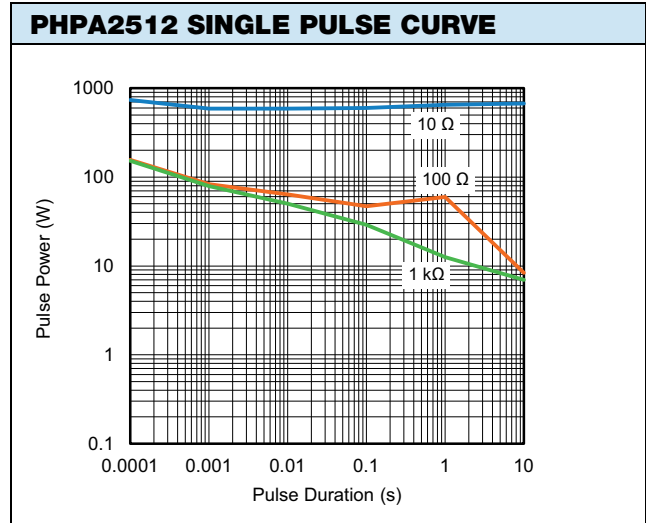
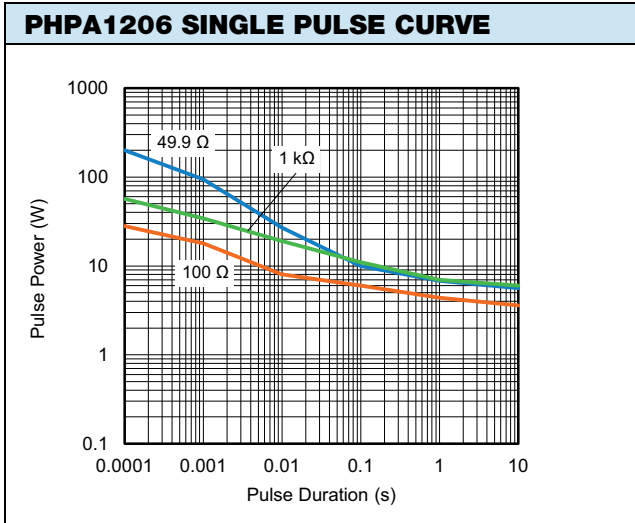

Notes

- Chip surface temperature measured using FLIR A40 thermal imaging system with an approximate test card surface temperature of 25 °C
- Thermal imaging was conducted under ambient conditions resulting in a steady state test card surface temperature of 85 °C over the full range of power levels
- Thermal imaging and load life testing was conducted mounting one device to 2" x 3" test cards with 2.5 mil copper plating on both surfaces. Thermal vias on 120 mil centers were utilized for heat transfer between surfaces of the test card

Notes

- Chip surface temperature measured using FLIR A40 thermal imaging system with an approximate test card surface temperature of 25 °C

Case Size	2512	2512	2512
Resistance Value	Up to 10 Ω	Up to 100 Ω	Up to 1 kΩ
Temperature	Power (W)		
70	2.67	2.02	1.89
150	7.17	5.34	4.94
200	9.94	7.15	6.48

DERATING CURVE

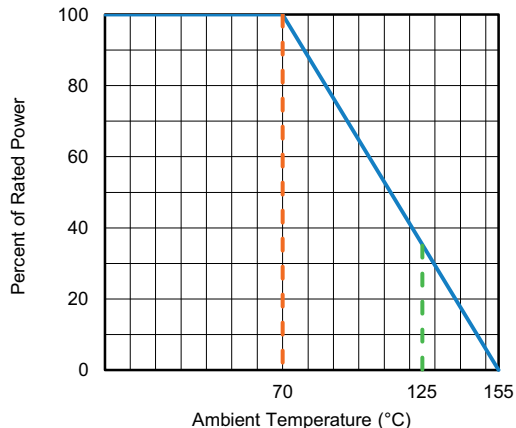

GLOBAL PART NUMBER INFORMATION

P H P A 1 2 0 6 E 1 0 0 2 B S T 1

GLOBAL MODEL	CASE SIZE	TCR ⁽¹⁾	RESISTANCE	TOLERANCE	TERMINATION	PACKAGING
PHPA	1206 2512	E = ± 25 ppm/°C H = ± 50 ppm/°C K = ± 100 ppm/°C	The first 3 digits are significant figures and the last digit specifies the number of zeros to follow. "R" designates the decimal point. Example: 10R0 = 10 Ω 1000 = 100 Ω 1001 = 1 kΩ	B = ± 0.1 % D = ± 0.5 % F = ± 1.0 % G = ± 2.0 % J = ± 5.0 %	S = wraparound 100 % electroplated pure matte tin RoHS-compliant - e3	BULK BS = 100 min., 1 mult. WAFFLE WS = 100 min., 1 mult. W0 = 100 min., 100 mult. W1 = 100 min., 1 mult. ⁽²⁾ WP = 100 min., 1 mult. ⁽³⁾ TAPE AND REEL T0 = 100 min., 100 mult. T1 = 1000 min., 1000 mult. ⁽⁴⁾ T3 = 300 min., 300 mult. T5 = 500 min., 500 mult. TF = full reel TS = 100 min., 1 mult. TI = 100 min., 1 mult. ⁽²⁾ TP = 100 min., 1 mult. ⁽³⁾

Notes

- (1) < 50 Ω "E" TCR characteristic is not available
- (2) Item single lot date code
- (3) Package unit single lot date code
- (4) Preferred packaging code



Disclaimer

ALL PRODUCT, PRODUCT SPECIFICATIONS AND DATA ARE SUBJECT TO CHANGE WITHOUT NOTICE TO IMPROVE RELIABILITY, FUNCTION OR DESIGN OR OTHERWISE.

Vishay Intertechnology, Inc., its affiliates, agents, and employees, and all persons acting on its or their behalf (collectively, "Vishay"), disclaim any and all liability for any errors, inaccuracies or incompleteness contained in any datasheet or in any other disclosure relating to any product.

Vishay makes no warranty, representation or guarantee regarding the suitability of the products for any particular purpose or the continuing production of any product. To the maximum extent permitted by applicable law, Vishay disclaims (i) any and all liability arising out of the application or use of any product, (ii) any and all liability, including without limitation special, consequential or incidental damages, and (iii) any and all implied warranties, including warranties of fitness for particular purpose, non-infringement and merchantability.

Statements regarding the suitability of products for certain types of applications are based on Vishay's knowledge of typical requirements that are often placed on Vishay products in generic applications. Such statements are not binding statements about the suitability of products for a particular application. It is the customer's responsibility to validate that a particular product with the properties described in the product specification is suitable for use in a particular application. Parameters provided in datasheets and / or specifications may vary in different applications and performance may vary over time. All operating parameters, including typical parameters, must be validated for each customer application by the customer's technical experts. Product specifications do not expand or otherwise modify Vishay's terms and conditions of purchase, including but not limited to the warranty expressed therein.

Hyperlinks included in this datasheet may direct users to third-party websites. These links are provided as a convenience and for informational purposes only. Inclusion of these hyperlinks does not constitute an endorsement or an approval by Vishay of any of the products, services or opinions of the corporation, organization or individual associated with the third-party website. Vishay disclaims any and all liability and bears no responsibility for the accuracy, legality or content of the third-party website or for that of subsequent links.

Except as expressly indicated in writing, Vishay products are not designed for use in medical, life-saving, or life-sustaining applications or for any other application in which the failure of the Vishay product could result in personal injury or death. Customers using or selling Vishay products not expressly indicated for use in such applications do so at their own risk. Please contact authorized Vishay personnel to obtain written terms and conditions regarding products designed for such applications.

No license, express or implied, by estoppel or otherwise, to any intellectual property rights is granted by this document or by any conduct of Vishay. Product names and markings noted herein may be trademarks of their respective owners.