

MIDI® Fuses



Clear MIDI® Fuses

One Hole MIDI® Fuses

(clear nylon composite cover)

MIDI®, Clear MIDI®, and One Hole MIDI® Style Bolt-down Fuse Rated 32V

This MIDI® style fuse offers a bolt-on space saving fuse for high current wiring protection and provides time delay characteristics with “Diffusion Pill Technology”.

Specifications

Interrupting Rating:	2000A @ 32 VDC
Voltage Rating:	32 VDC
Operating Temperature Range:	-40°C to + 125°C
Black Housing Material:	PA66-GF25 (U.L. 94 Flammability rating – V0)
Clear Housing Material:	PA6/66 (U.L. 94 Flammability rating – HB)
Terminal:	Tin plated Copper
Mounting Torque M5:	4.5 Nm +/- 1Nm
Mounting Torque M6:	6.0 Nm +/- 1Nm
Refers to:	ISO 8820-5:2003
Complies with:	Standard UL 248-1 as a Special Purpose Fuses in UL file E71611 (40-100A) and Directive 2011/65/EU



Ordering Information

Part Number	Package Size	Housing Color	Bolt Size	Bolt Hole Qty	Mfg Location
0498xxx.M	1000	Black	M5	2	Mexico
0498xxx.M-CN	1000	Black	M5	2	China
0498xxx.H	100	Black	M5	2	Mexico
0498xxx.MXM6	1000	Black	M6	2	Mexico
0498xxx.MXM6-CN	1000	Black	M6	2	China
0498xxx.MX1M5	1000	Black	M5	1	Mexico
0498xxx.MX1M5-CN	1000	Black	M5	1	China
0498xxx.MX1M6	1000	Black	M6	1	Mexico
0498xxx.MX1M6-CN	1000	Black	M6	1	China
0498xxx.MXT	1000	Clear	M5	2	Mexico
0498xxx.MXT-CN	1000	Clear	M5	2	China
0498xxx.MXTM6	1000	Clear	M6	2	Mexico
0498xxx.MXTM6-CN	1000	Clear	M6	2	China

* Materials manufactured in Asia are produced to the same specifications as materials manufactured in North America, and meets the same test requirements. Multiple production locations are for capacity expansion only.

Time-Current Characteristics

% of Rating	Opening Time Min / Max	
	23A-125A	150A-200A
75	- / -	360,000 s / -
100	360,000 s / -	- / -
110	14,400 s / -	- / -
150	90 s / 3,600 s	- / -
200	5 s / 100 s	1 s / 15 s
300	0.5 s / 3 s	0.3 s / 3 s
500	0.1 s / 1 s	0.1 s / 1 s

Ratings

Part Number	Current Rating (A)	Font Color	Typ. Voltage Drop (mV)	Typ. Cold Resistance (mΩ)	I ² t (A ² s)
0498023.M ²	23	White	90	3.43	1,800
0498030._ ²	30	Orange	65	2.06	4,200
0498040._	40	Green	65	1.398	10,000
0498050._	50	Red	65	1.025	13,000
0498060._	60	Yellow	68	0.865	21,700
0498070._	70	Brown	70	0.72	24,000
0498080._	80	White	58	0.541	24,600
0498100._	100	Blue	60	0.457	51,300
0498125._ ²	125	Pink	71	0.394	73,200
0498150._ ^{1,2}	150	Grey	77	0.323	81,900
0498175._ ^{1,2}	175	Dark Green	77	0.285	100,000
0498200._ ^{1,2}	200	Purple	77	0.261	125,000

Note 1: Short Circuit Protector only
Note 2: Not UL Recognized

REV06122020

Littelfuse products are not designed for, and shall not be used for, any purpose (including, without limitation, automotive, military, aerospace, medical, life-saving, life-sustaining or nuclear facility applications, devices intended for surgical implant into the body, or any other application in which the failure or lack of desired operation of the product may result in personal injury, death, or property damage) other than those expressly set forth in applicable Littelfuse product documentation. Warranties granted by Littelfuse shall be deemed void for products used for any purpose not expressly set forth in applicable Littelfuse documentation. Littelfuse shall not be liable for any claims or damages arising out of products used in applications not expressly intended by Littelfuse as set forth in applicable Littelfuse documentation. The sale and use of Littelfuse products is subject to Littelfuse Terms and Conditions of Sale, unless otherwise agreed by Littelfuse.

MIDI®, Clear MIDI®, and One Hole MIDI® Style Bolt-down Fuse Rated 32V

Dimensions

Dimensions in mm

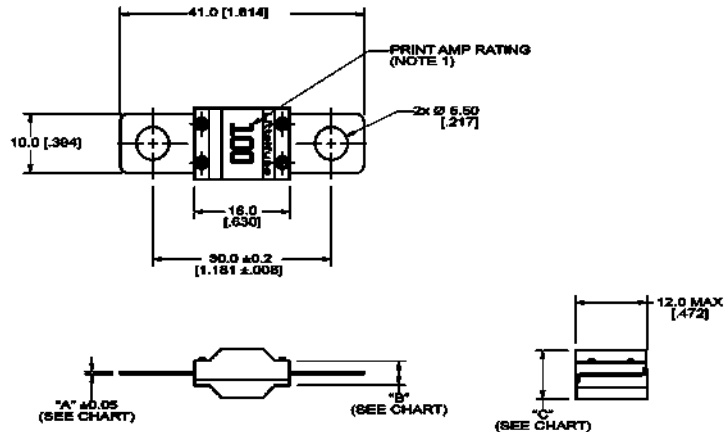

Temperature Derating Curve

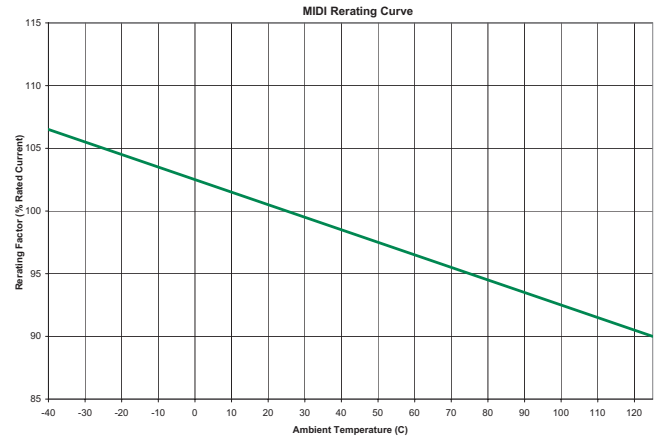

Part Number	"A" mm (inch)	"B" mm (inch)	"C" mm (inch)
0498023_	0.41 (0.016)	4.0 (0.157)	8.0 (0.315)
0498030_	0.41 (0.016)	4.0 (0.157)	8.0 (0.315)
0498040_	0.41 (0.016)	4.0 (0.157)	8.0 (0.315)
0498050_	0.41 (0.016)	4.0 (0.157)	8.0 (0.315)
0498060_	0.41 (0.016)	4.0 (0.157)	8.0 (0.315)
0498070_	0.41 (0.016)	4.0 (0.157)	8.0 (0.315)
0498080_	0.41 (0.016)	4.0 (0.157)	8.0 (0.315)
0498100_	0.63 (0.025)	4.3 (0.169)	8.3 (0.327)
0498125_	0.63 (0.025)	4.3 (0.169)	8.3 (0.327)
0498150_	0.63 (0.025)	4.3 (0.169)	8.3 (0.327)
0498175_	0.63 (0.025)	4.3 (0.169)	8.3 (0.327)
0498200_	0.63 (0.025)	4.3 (0.169)	8.3 (0.327)

Time-Current Characteristic Curves

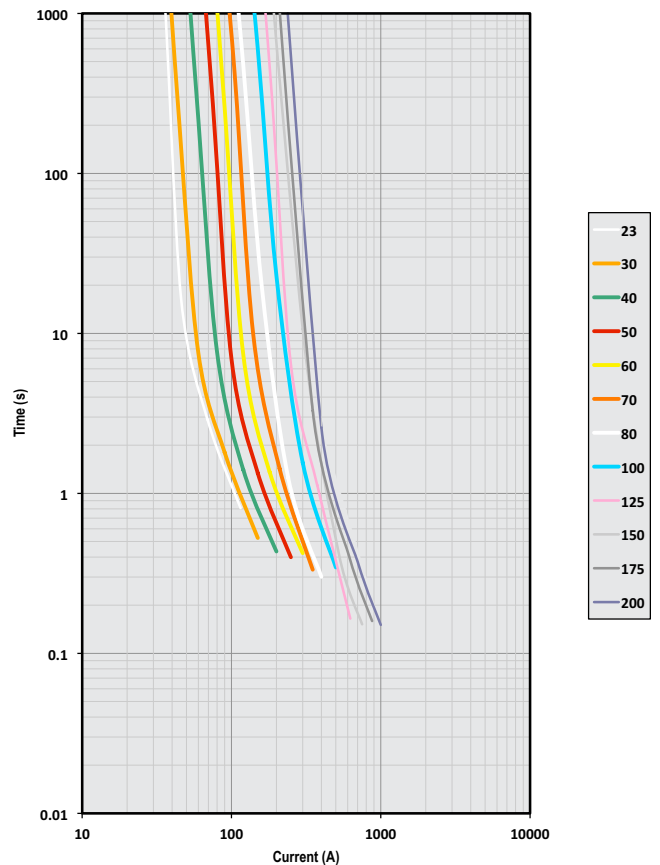

REV06122020

Littelfuse products are not designed for, and shall not be used for, any purpose (including, without limitation, automotive, military, aerospace, medical, life-saving, life-sustaining or nuclear facility applications, devices intended for surgical implant into the body, or any other application in which the failure or lack of desired operation of the product may result in personal injury, death, or property damage) other than those expressly set forth in applicable Littelfuse product documentation. Warranties granted by Littelfuse shall be deemed void for products used for any purpose not expressly set forth in applicable Littelfuse documentation. Littelfuse shall not be liable for any claims or damages arising out of products used in applications not expressly intended by Littelfuse as set forth in applicable Littelfuse documentation. The sale and use of Littelfuse products is subject to Littelfuse Terms and Conditions of Sale, unless otherwise agreed by Littelfuse.