

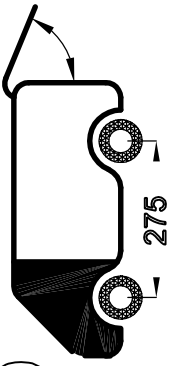









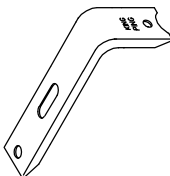
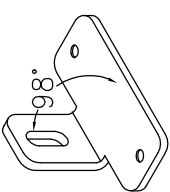
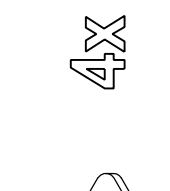
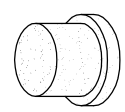

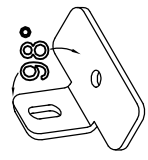
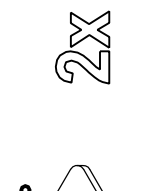



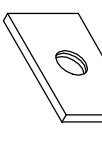
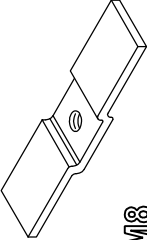

FIAT DOBLO CARGO

OPEL COMBO D

2010

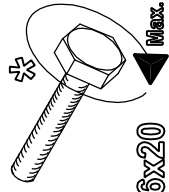
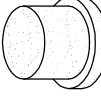
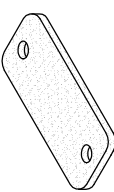
200x140 cm. L1

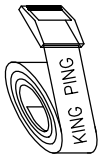
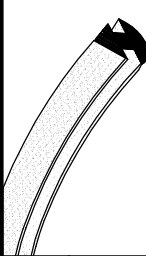
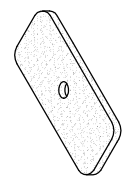

 6X	 4X	 6X	 6X
 18X	 2X	 2X	 6X
 18X	 12X	 12X	 6X
 6X	 12X	 12X	 6X
 10X	 10X	 10X	 10X
 10X	 4X	 4X	 6X
 2X	 1X	 2X	 2X

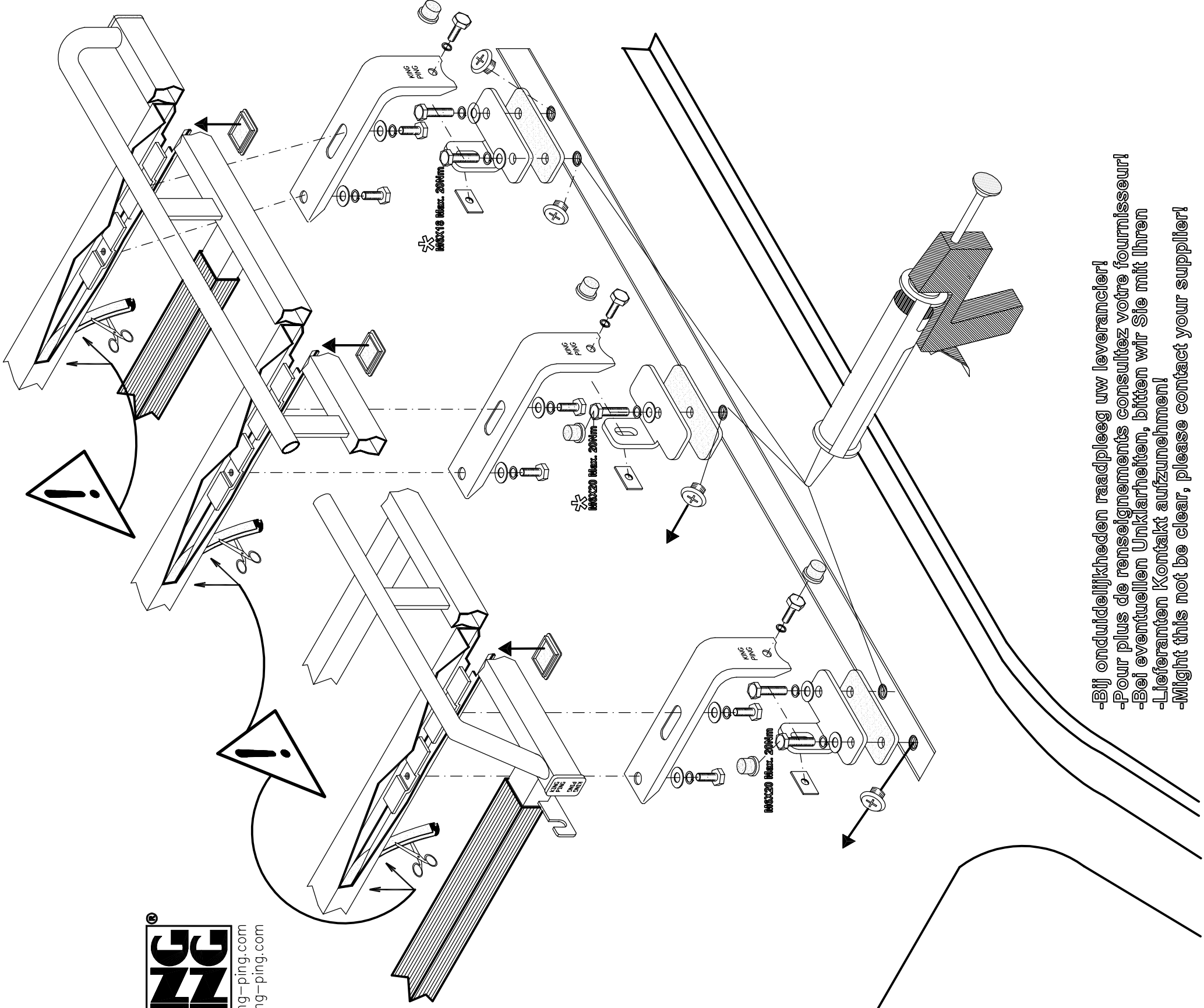
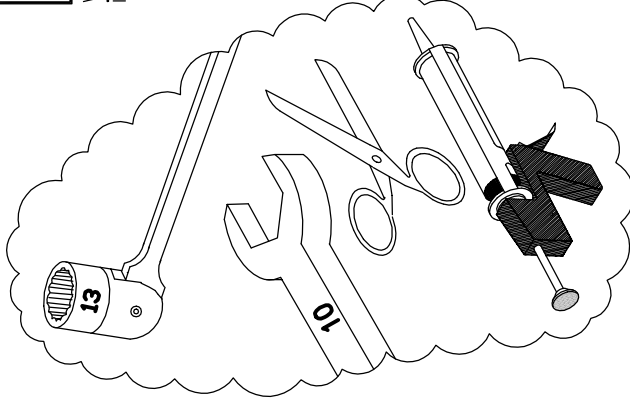

- Bij onduidelijkheden raadpleeg uw leverancier!
- Pour plus de renseignements consultez votre fournisseur!
- Bei eventuellen Unklarheiten, bitten wir Sie mit Ihren
- Lieferanten Kontakt aufzunehmen!
- Might this not be clear, please contact your supplier!

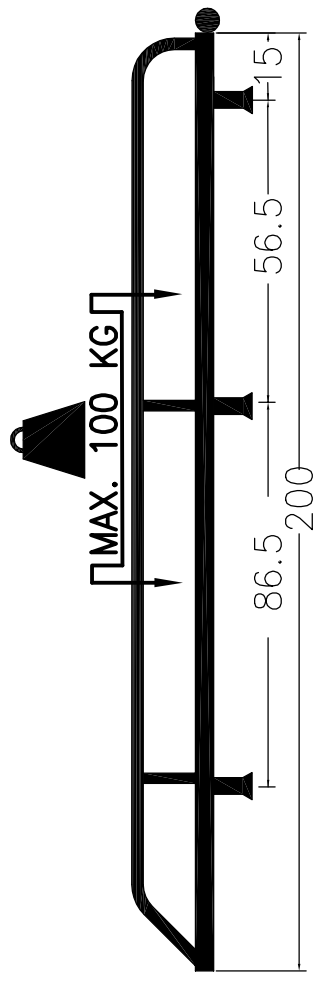

FIDK200140S- 11/2011