

DO NOT SCALE
DIMENSIONS IN mm

METRIC

THIRD ANGLE
PROJECTION

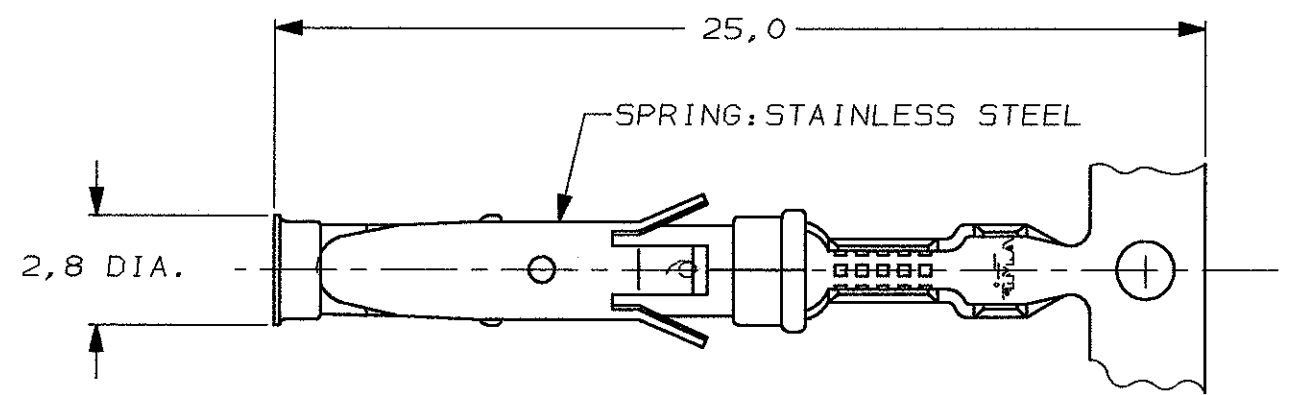

STRIP

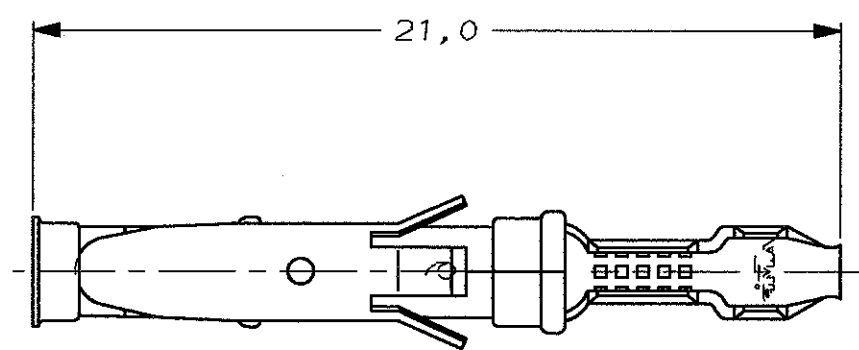

LOOSE-PIECE

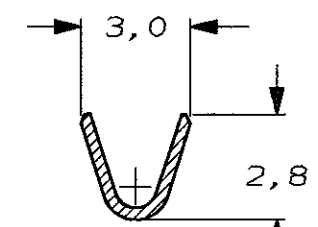
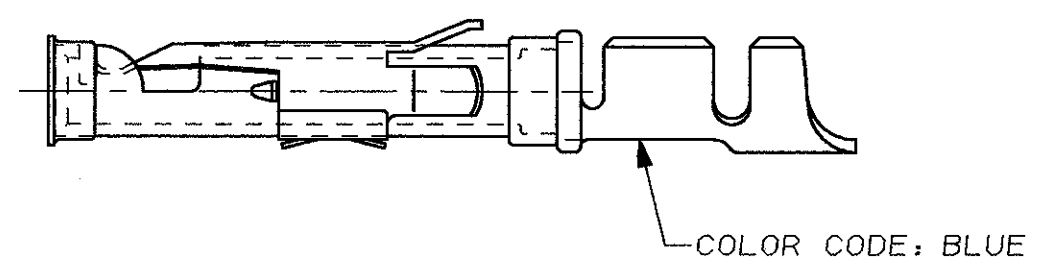
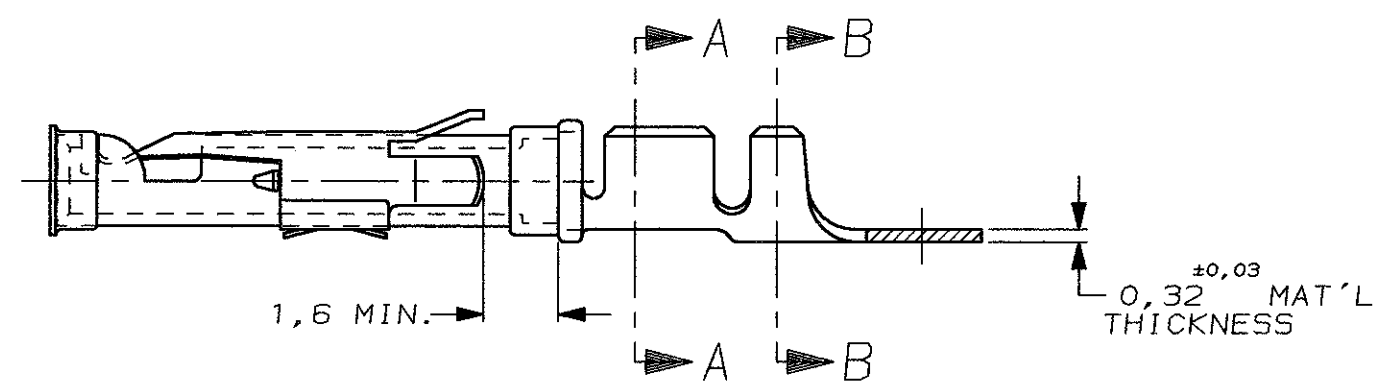

SECTION A-A

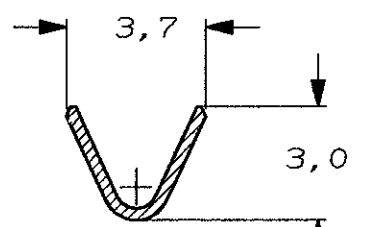

SECTION B-B

WIRE RANGE : 0,75-1,50 mm² (18-16 AWG)
INSUL. RANGE : 2,0 -2,5 mm (.080-.100)

DIRECTION OFF TOP OF REEL
AMPOMATOR + MINI-APPL.
107-3-F16.1 $\triangle A$
107-3-F16.2 $\triangle B$
107-3-F16.4 $\triangle C$

5-163083-3	$\triangle A$	$\triangle C$		BRASS	ECON. GOLD	$\triangle 21$
5-163083-2	$\triangle 1$	$\triangle 4$		BRASS	SEL. GOLD	$\triangle 22$
5-163083-1	$\triangle 1$	$\triangle 4$		BRASS	EL. TIN	$\triangle 20$
1-163083-4		$\triangle A$	1-163084-4	BRASS	EL. TIN	$\triangle 31$ $\triangle 20$
1-163083-3		$\triangle A$	1-163084-3	BRASS	BR. TIN/LEAD	$\triangle 30$
1-163083-2		$\triangle A$		BRASS	SILVER	$\triangle 28$
1-163083-1		$\triangle A$		BRASS	ECON. GOLD	$\triangle 21$
1-163083-0		$\triangle B$	1-163084-0	BRASS	ECON. GOLD	$\triangle 21$
163083-9		$\triangle B$		BRASS	SILVER	$\triangle 28$
163083-8		$\triangle A$		BRASS	EL. TIN	$\triangle 20$
163083-7		$\triangle A$		BRASS	SEL. GOLD	$\triangle 22$
163083-2	$\triangle 1$	$\triangle B$	163084-2	BRASS	SEL. GOLD	$\triangle 22$
163083-1	$\triangle 1$	$\triangle B$	163084-1	BRASS	EL. TIN	$\triangle 20$
PARTNUMBER	DIRECTION OF REEL		LOOSE-PIECE	MATERIAL	PLATING	

NOTES	MATERIAL	THICKNESS	AREA
$\triangle 20$	TIN	2,0 μ m	ALL OVER
$\triangle 21$	NICKEL GOLD TIN/LEAD	0,8 μ m	ALL OVER CONTACT AREA BARREL
$\triangle 22$	NICKEL GOLD GOLD	0,8 μ m	ALL OVER CONTACT AREA ALL OVER
$\triangle 23$	NICKEL GOLD GOLD	1,2 μ m	ALL OVER CONTACT AREA ALL OVER
$\triangle 24$	NICKEL SILVER TIN/LEAD	2,5 μ m	ALL OVER CONTACT AREA BARREL
$\triangle 25$	SILVER NICKEL	1,5-2,5 μ m 0,76 μ m	ALL OVER ALL OVER
$\triangle 26$	SILVER	2,5 μ m	ALL OVER
$\triangle 27$	NICKEL TIN/LEAD	1,27 μ m 1,27 μ m	ALL OVER ALL OVER
$\triangle 31$	LUBRICATED		

REV.	DESCRIPTION	DR.	CHK.	DATE	
AZ	EBD0-0003-05	AM	FWK	05/01/05	
AY	EBD0-0335-04	JMS	FWK	02/08/04	
V	EH-1020-98	D.K.	R.V.	08 JUL 98	
U	EH-1347-96	JvL	RV	21-11-96	
T	EH-0302-94	JvL	MvD	03-05-94	
S	ECN H-9813	JvdH	RD	18-05-92	
R	ECN H-9192	MvD	RD	09-10-91	
LTR.	REVISION RECORD	DR.	CHK.	DATE	
DR.:	-	CHK.:	-	APP.:	-
DATE:	-	DATE:	-	DATE:	-

CUSTOMER DRAWING FOR REFERENCE ONLY
WILL NOT BE UPDATED

© COPYRIGHT 19- BY AMP HOLLAND B.V.
ALL INTERNATIONAL RIGHTS RESERVED. AMP PRODUCTS MAY BE
COVERED BY U.S. AND FOREIGN AND/OR PATENTS PENDING.
THIS DRAWING IS UNPUBLISHED
RELEASED FOR PUBLICATION _____, 19____

AMP AMP HOLLAND B.V.
's-Hertogenbosch,
The Netherlands.

NAME _____

**SOCKET TYPE III CONTACT
SIZE 16**

DWG. No. 163083
REV. LTR. SHEET
AZ 1 OF 1 A3

NOTES :

- U.L. RECONIZED UNDER FILE E28476 VOL. VI SEC. I .
- FOR CRIMPDETAILS SEE AMP-SPEC. 114-19.000 .
- MEETS PRODUCTSPECIFICATION 108-10042.
- SPECIAL REEL WITH 200 PCS FOR REEL-FED HANDTOOL.

Connector Series and Types

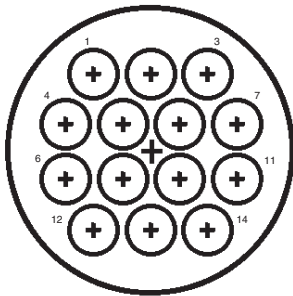

Series 1—Size 16 Contacts

Series 1 connectors permit the use of multiple combinations of signal and coaxial circuits in the same housing by accepting durable Multimate contacts. These pin and socket contacts include Type III+ and

subminiature coaxial contacts, interchangeable in the same Multimate contact cavity. Type III+ contacts (.062 [1.57] pin diameter) are capable of carrying a maximum of 13 amperes when crimped in wire.

Type III solder contacts and posted contacts for pc board applications are also available. Many connector arrangements offer both standard and reverse sex contact loading—**from 4 thru 37 positions.**

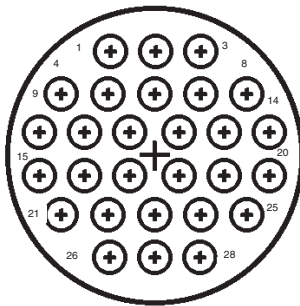

Series 2—Size 20 Contacts

Series 2 connectors accept Size 20 DF (precision formed) and Size 20 DM (screw-machined) pin and socket contacts with a .040 [1.02] pin diameter. Size 20 DF contacts are available in crimp and solder versions, as well as a posted version

for wrap-type and pc board applications. Maximum current carrying capability is 7.5 amperes. Many connector arrangements offer both standard and reverse sex contact loading—**from 8 thru 63 positions.**

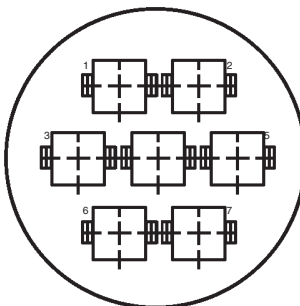

Series 3—Power Contacts

Series 3 connectors accept Type XII power contacts which can carry up to 25 amps per contact. These contacts will accommodate a wire size range of 16 to

10 AWG [1.4 to 5 mm²]. Two connector sizes are available in both standard and reverse sex connector arrangements **3 and 7 positions.**

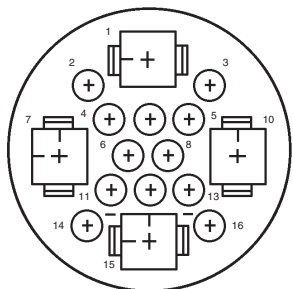

Series 4—Combination Size 16 and Power Contacts

Series 4 connectors accept Size 16 Multimate and Type XII power contacts, combining the signal and coaxial circuit capabilities of Series 1 connectors with the

power circuit capabilities of Series 3 connectors. Available in two connector sizes offering power mixing combinations totaling **16 and 22 positions.**

Connector Series and Types (Continued)

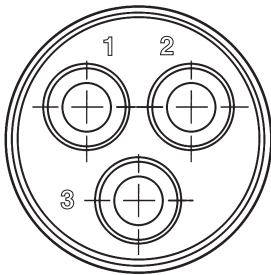

**Series 5—Power Contacts
.125 POWERBAND**

Series 5 connectors combine the revolutionary performance of the new AMP POWERBAND Contact, high current contact in configurations similar to the Series 3 connectors. AMP POWERBAND contacts offer the electrical

performance of the best Mil Spec Size 8 screw-machined contacts with the economy and productivity of strip-fed, precision formed contacts.

Series 5 connectors are environmentally sealable to meet IEC IP 65 and IP 67 specifications.

Rated at 600 VAC or VDC, 45 amperes maximum in a single contact, the connectors are available in free-hanging and panel-mount applications—**one connector configuration containing three .125 POWERBAND contacts.**

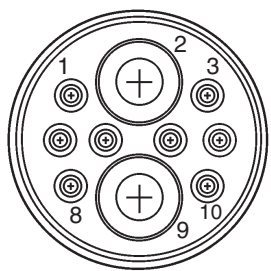

**Series 6—Combination,
Size 16 and .125
POWERBAND Contacts**

Series 6 combines the high current and environmental sealing capability of Series 5, POWERBAND contacts, and the reliability of signal carrying, low current Type III+ contacts.

This combination of power and signal contacts is offered in **one connector configuration containing two .125 POWERBAND contacts and eight Type III+ signal pin and socket contacts.**

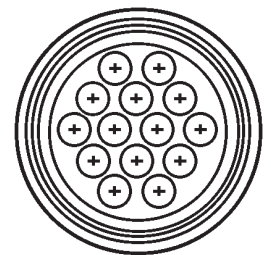

**MIL-C-5015 Style—Size 16
Contacts**

This new addition to the AMP Circular Plastic Connector Line is specifically designed to be **intermateable with Metal-Shell size 20-14 and 18-10, MIL-C-5015 Style connector systems.** The high impact resistant plastic housing offers the advantages of light weight

and lower cost than existing metal-shell connectors. In addition the connector design prevents mismatching when used with other insert arrangements. As part of the AMP Multimatch family of connectors, the MIL-C-5015 style connector offers the

economies of crimp Type III+ pin and socket contacts in reel-mounted, strip-form for high volume automatic machine termination, as well as in loose piece-form for low volume, prototype or maintenance and repair.

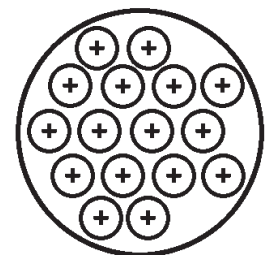

**Metal-Shell, Circular
Plastic Connectors**

Metal-Shell CPC connectors consist of a black thermoplastic insert in a nickel-plated, zinc alloy shell. These connectors are currently available in

shell sizes 14, 22 and 28, and in two basic configurations consisting of plugs and square flange receptacles.

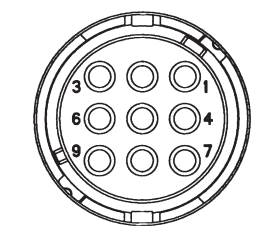

Miniature CPC Connectors

These compact connectors accept existing Mini-Universal MATE-N-LOK pin and socket contacts, 30-18 AWG [.05-.8 mm²].

Two shell sizes (8 or 11) are available, accommodating **from 1 to 4 and 5 to 9 positions.**

Featuring high contact density and IP67 sealing, these durable connectors are well suited for many wire-to-wire, wire-to-board, and wire-to-panel applications.

Current Carrying Capabilities

The total current capacity of each contact in a given connector is dependent upon the heat rise resulting from the combination of electrical loads of the contacts in the connector arrangement and the maximum ambient temperature in which the connector will be operating. Caution must be taken so that this combination of conditions does not cause the internal temperature of the connector to exceed the maximum operating temperature of the housing material. Several variables which must be considered when determining this maximum current capability for your application are:

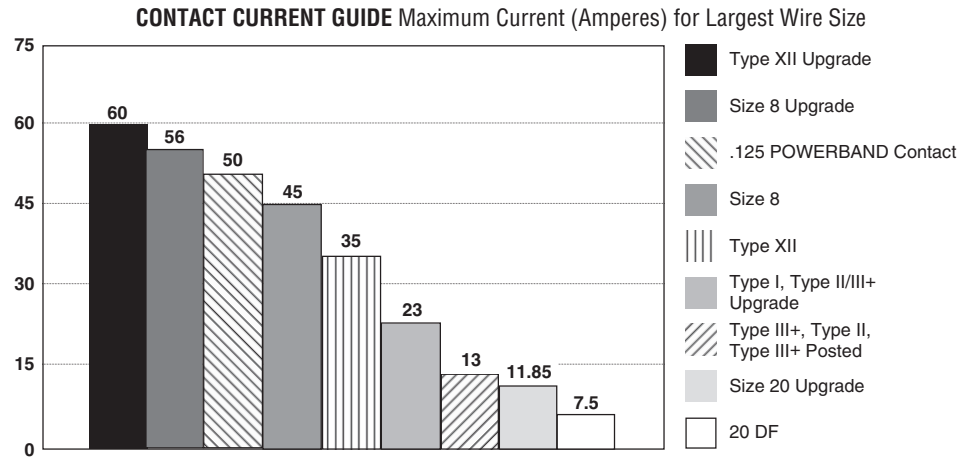

■ **Wire Size**—Larger wire will carry more current since it has less internal resistance to current flow and generates less heat. The wire also conducts heat away from the connector.

■ **Connector Size**—In general, with more circuits in a connector, less current per contact can be carried.

■ **Current Load Distribution**—Spreading those lines with greater current loads throughout the connector, particularly around the outer perimeter, will enhance heat dissipation.

■ **Ambient Temperature**—With higher ambient temperatures, less current can be carried.

Current Rating Verification Can a contact rated at 10 amps carry 10 amps?

Maybe yes, but probably not. The reason lies in the test conditions used to rate the contact. If these conditions do not adequately reflect the application conditions, the actual allowable current levels may be lower than specified levels. For example, many manufacturers, including Tyco Electronics, test a single contact in air. This gives an accurate measure of the basic current-carrying capacity of the contact. Use the contact alone in air and it can certainly carry 10 ampere. Use it in a multi-position connector surrounded by other current-carrying contacts or in high ambient temperatures, and the contact should carry less current.

Similarly, as the contact ages and stress relaxation, environmental cycling, and other degradation factors take their toll, the contact's current-carrying capacity decreases. A prudent design must set current levels for such end-of-

design-life (EODL) conditions. Practical current-carrying capacity is not an absolute, but an application-dependent condition.

New Method Simplifies Ratings

To help the designer set the appropriate current level, Tyco Electronics has developed a method of specifying current-carrying capacity. This method takes into account the various application factors that influence current rating.

The method can be summarized as follows:

- The contact is aged to EODL conditions by durability cycling, thermal cycling, and environmental exposure.
- The contact's resistance stability is verified.
- The current necessary to produce the specified temperature rise is measured. This T-rise is usually 30°C.
- A rating factor is determined to allow derating of multiple contacts in the same housing and for different conductor sizes.

Temperature

One other factor influencing current levels is the maximum operating temperature, for example, 105°C. If the application has a high ambient temperature (over 75°C) the contact's T-rise is limited by the maximum operating temperature. For example, an application temperature of 90°C limits the contact T-rise to 15°C. Since current produces heat (the I²R law), the current must be lowered to limit the T-rise.

A contact's T-rise depends not only on its I²R Joule heating, but also on its ability to dissipate the heat. Consider a contact in a multi-contact housing. Joule heating in multiple contacts will raise the local ambient temperature. Since the contact will not be able to dissipate its own heat as well by convection, the maximum T-rise will be realized at a lower current level. Consequently, the allowable current level must be lower to maintain an acceptable T-rise.

For a given connector, the current level will be set by the

loading density. A connector containing 50% current-carrying contacts will permit higher currents (per contact) than a connector will at 75% loading. The loading percentage assumes an even distribution of contacts within the housing. If all 10 contacts are grouped together in one section of a 20-position connector, the loading density may approach 100%.

The Importance of EODL

As stated, T-rise in a contact depends on both resistance and current. As it ages, a contact's resistance will increase. The contact designer will specify a maximum resistance for the contact, this level is the end-of-design-life resistance. Before the contact is tested for current, Tyco Electronics subjects it to a sequence of tests that exercises the major failure mechanisms and thereby simulates EODL conditions. Conditioning includes mating cycling, industrial mixed-flowing gases, humidity and temperature cycling, and vibration to sequentially introduce wear, corrosion, stress relaxation, and mechanical disturbance.

Note: All part numbers are RoHS Compliant.

Presentation — An Example*

Current Rating

The presentation of current-carrying capacity in AMP product specifications includes two parts:

- First, a base curve showing current levels versus T-rise for a single circuit and the largest wire size (See figure 1). This represents the maximum current capacity of the contact. The curve is usually flat up to 75°C ambient and then drops off. Up to 75°C, the 30°C T-rise limits the amount of current, and above 75°C the current must be reduced to keep the combination of ambient temperature and T-rise from exceeding the maximum operating temperature of 105°C.
- Next are rating factors, a table of multipliers to account for connector loading and for smaller wire sizes (See figure 2). The designer first determines the base current for the ambient conditions of the application; then multiplies this base current by the rating factors to find the current level for the application's loading factor and wire size.

Practical Values

The current-rating method gives designers practical values applicable to their applications. While the specified current levels for a contact may be lower than for other testing methods, they are more practical and simplify the system design process.

"Spec-manship" is replaced by a realistic assessment of the current-carrying capacity of a contact under varying conditions of temperature, connector loading, and wire size.

Specific current-carrying data based on EOL and % loading is available from Tyco Electronics. Please contact your local Tyco Electronics Sales Engineer or call Tyco Electronics.

Connector/Contact Acceptability

As previously stated, choosing the correct connector/contact combination is fundamental to the successful function of all connectors. The Selector Chart shown at right, is designed to simplify your choice

of connectors and their acceptable contacts. Once you have selected the wire size, current-carrying capacity need, number of positions required, and the type of contacts needed in your choice of connector, refer to this matrix for a quick look at exactly what is acceptable in a given connector type.

***Note:** Data is *not* typical of a specific CPC connector configuration. For specific current rating information based on % connector loading, contact Tyco Electronics.

To demonstrate the method of specifying current, consider the following application conditions; an ambient temperature of 65°C, a 50% loading of contacts in the housing, and 20 AWG [0.6mm²] wire.

- From Figure 1, the base current rating is 14 ampere with 18 AWG [0.8mm²] wire.
- Figure 2, the rating factor for 50% loading and 20 AWG [0.6mm²] wire is 0.68.
- The specific rating for this application is the product of the base rating and the rating factor:
 $14 \times 0.68 = 9.5$ ampere
- Each of the contacts can carry 9.5 ampere.
- However, if the ambient temperature is 80°C the allowable T-rise becomes 25°C. The base current must be lowered to 12.8 ampere so that the 105°C maximum operating temperature is not exceeded. The current rating then becomes:
 $12.8 \times 0.68 = 8.7$ ampere.

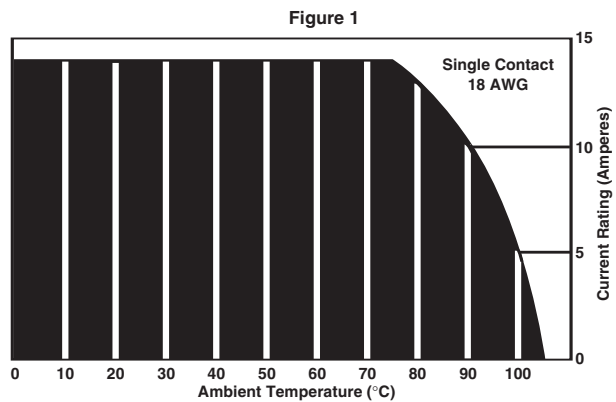

Graph shows the relationship between base current, ambient temperature, and contact T-rise.

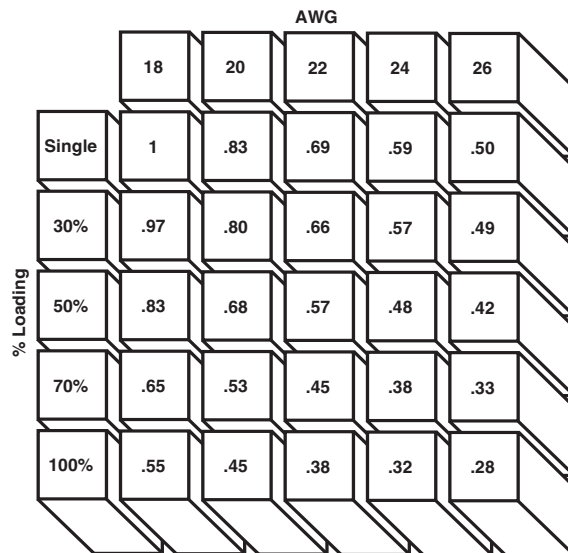

Rating factors allow the base current to be adjusted for various connector loading and wire sizes.

Contact Selector Chart

Connector Type	20 DF	Type I	Type II	Type III+	Posted Type III+	Type XII	Sub-Mini Coax	POWERBAND Contacts
CPC Series 1			✓	✓	✓		✓	
CPC Series 2	✓							
CPC Series 3						✓		
CPC Series 4			✓	✓		✓	✓	
CPC Series 5								✓
CPC Series 6		✓	✓	✓				✓
CPC 5015				✓				
CMC Series 1			✓	✓	✓		✓	
CMC Series 2	✓							
CMC Series 3						✓		
CMC Series 4			✓	✓		✓	✓	