

## Technical Data Sheet

### Chip LED with Right Angle Lens

#### 12-21SURC/S530-XX/TR8

#### Features

- Package in 8mm tape on 7" diameter reel.
- Compatible with automatic placement equipment.
- Compatible with infrared and vapor phase reflow solder process.
- Mono-color type.

#### Descriptions

- The 12-21 SMD Taping is much smaller than lead frame type components, thus enable smaller board size, higher packing density, reduced storage space and finally smaller equipment to be obtained.
- Besides, lightweight makes them ideal for miniature applications. etc.

#### Applications

- Automotive: backlighting in dashboard and switch.
- Telecommunication: indicator and backlighting in telephone and fax.
- Flat backlight for LCD, switch and symbol.
- General use.



#### Device Selection Guide

Chip		Lens Color
Material	Emitted Color	
AlGaInP	Hyper Red	Water Clear

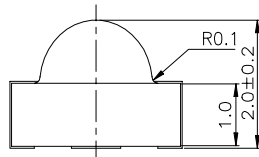
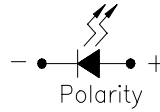
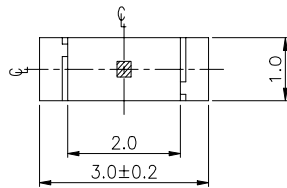
**Package Outline Dimensions**

For reflow soldering (propose)

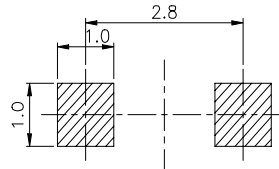
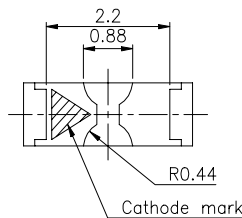
**Notes:** Tolerances Unless Dimension  $\pm 0.1\text{mm}$  , Angle  $\pm 0.5^\circ$  ,Unit = mm

**Absolute Maximum Ratings (Ta=25°C)**

Parameter	Symbol	Rating	Unit
Reverse Voltage	V <sub>R</sub>	5	V
Forward Current	I <sub>F</sub>	25	mA
Operating Temperature	Topr	-40 ~ +85	°C
Storage Temperature	Tstg	-40~ +90	°C
Soldering Temperature	Tsol	260 (for 5 second)	°C
Electrostatic Discharge	ESD	2000	V
Power Dissipation	Pd	60	mW
Peak Forward Current (Duty 1/10 @1KHz)	I <sub>F</sub>	160	mA

**12-21SURC/S530-XX/TR8**
**Electro-Optical Characteristics (Ta=25°C)**

Parameter	Symbol	*Chip Rank	Min.	Typ.	Max.	Unit	Condition
Luminous Intensity	Iv	A2	19	47	-----	mcd	IF=20 mA
		A3	45	68	-----		
		A4	62	92	-----		
		A5	75	115	-----		
		A6	90	139	-----		
Viewing Angle	2θ 1/2	-----	-----	120	-----	deg	IF=20mA
Peak Wavelength	λ p	-----	-----	632	-----	nm	IF=20mA
Dominant Wavelength	λ d	-----	-----	624	-----	nm	IF=20mA
Spectrum Radiation Bandwidth	Δ λ	-----	-----	20	-----	nm	IF=20mA
Forward Voltage	VF	-----	-----	2.0	2.4	V	IF=20mA
Reverse Current	IR	-----	-----	-----	10	μ A	VR=5V

**\*12-21SURC/S530-XX/TR8**

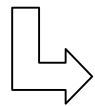

**Chip Rank**

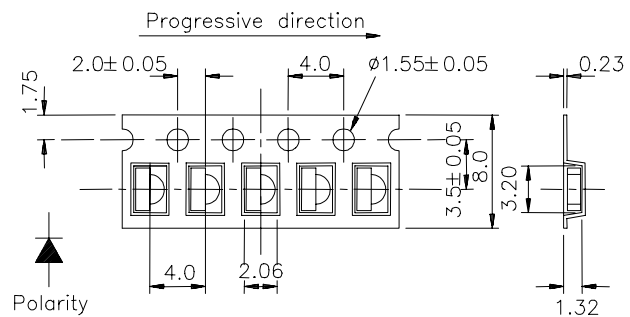
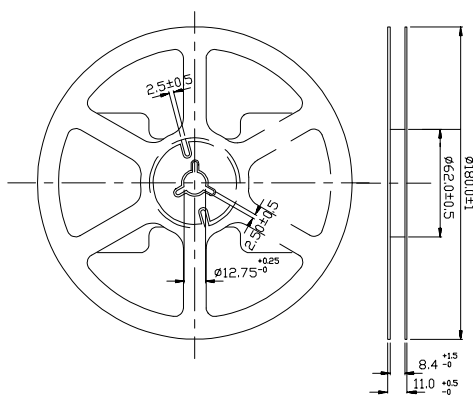
**Reel & Carrier Tape Dimensions**
**Loaded quantity per reel 2000 PCS/reel**

**Notes:** Tolerances Unless Dimension ± 0.1mm , Angle± 0.5° ,Unit = mm

**Typical Electro-Optical Characteristics Curves**

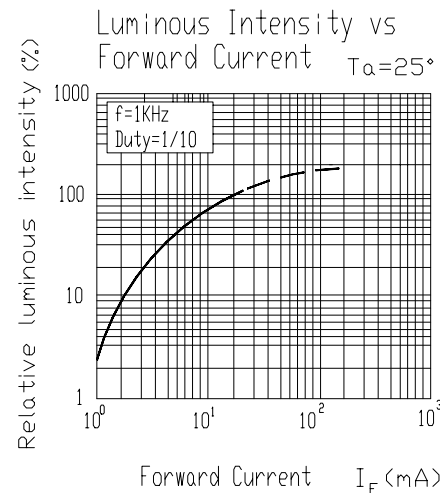
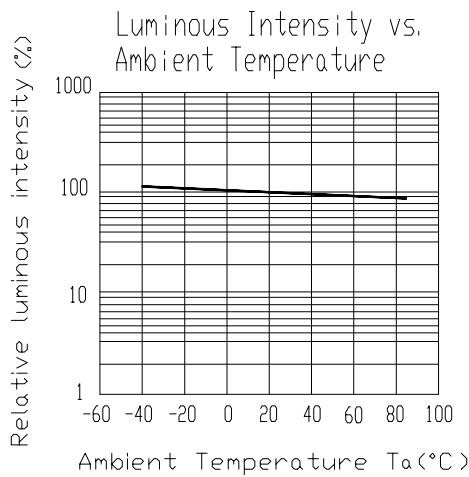
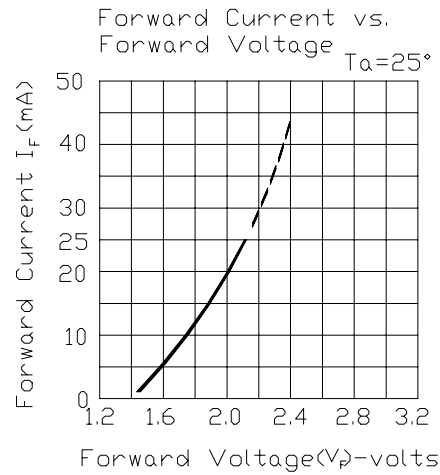
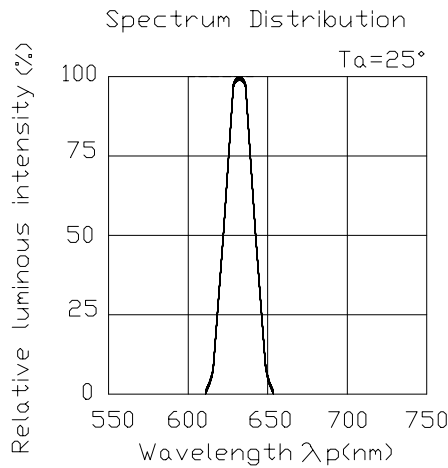

Forward Current Derating Curve

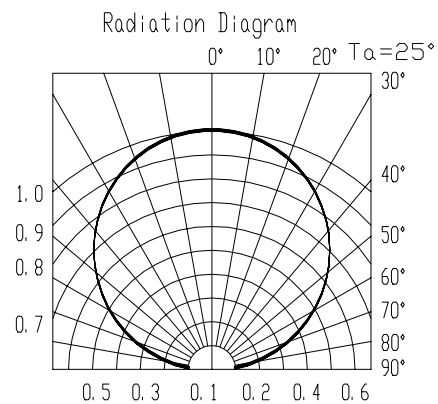
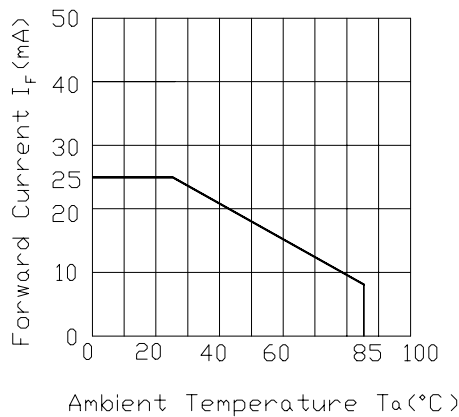

**12-21SURC/S530-XX/TR8****Reliability Test Items And Conditions**

The reliability of products shall be satisfied with items listed below.

Confidence level : 90 %

LTPD : 10 %

No.	Items	Test Condition	Test Hours/Cycles	Sample Size	Ac/Rc
1	Reflow	Temp. : 240°C ± 5°C Min. 5 sec.	6 min.	22 Pcs.	0/1
2	Temperature Cycle	H : +85°C 30min. ∫ 5 min. L : -55°C 30min.	50 Cycles	22 Pcs.	0/1
3	Thermal Shock	H : +100°C 5min. ∫ 10 sec. L : -10°C 5min.	50 Cycles	22 Pcs.	0/1
4	High Temperature Storage	Temp. : 100°C	1000 Hrs.	22 Pcs.	0/1
5	Low Temperature Storage	Temp. : -55°C	1000 Hrs.	22 Pcs.	0/1
6	DC Operating Life	I <sub>F</sub> = 20 mA	1000 Hrs.	22 Pcs.	0/1
7	High Temperature / High Humidity	85°C/R.H85%	1000 Hrs.	22 Pcs.	0/1

**12-21SURC/S530-XX/TR8**

**Precautions For Use**

1. Over-current-proof

Customer must apply resistors for protection , otherwise slight voltage shift will cause big current change ( Burn out will happen ).

2. Storage time

2.1 The operation of Temperature and RH are : 5°C ~35°C , RH60%.

2.2 Once the package is opened, the products should be used within a week. Otherwise, they should be kept in a damp proof box with desiccating agent. Considering the tape life , we suggest our customers to use our products within a year(from production date).

2.3 If opened more than one week in an atmosphere 5°C ~35°C , RH 60%, they should be treated at 60°C± 5°C for 15hrs.

2.4 When you discover that the desiccant in the package has a pink color (Normal = blue) , you should treat them in the same conditions as 2.3.

**Soldering heat**

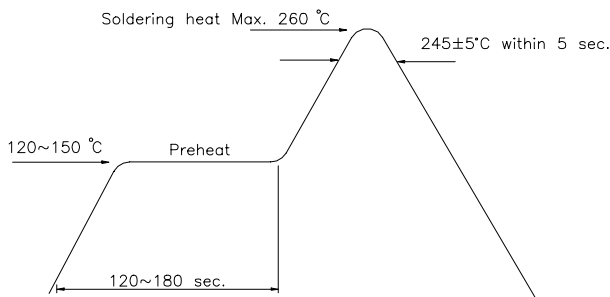

**Reflow Temp / Time**

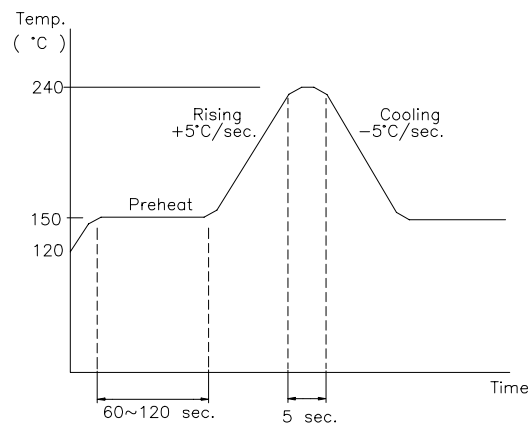

**Soldering Iron**

Basic spec is ≤ 5 sec when 260°C. If temperature is higher, time should be shorter (+10°C → -1sec). Power dissipation of Iron should be smaller than 15 W , and temperature should be controllable. Surface temperature of the device should be under 230 °C .

**Rework**

1. Customer must finish rework within 5 sec under 245°C.
2. The head of iron can not touch copper foil.
3. Twin-head type is preferred.

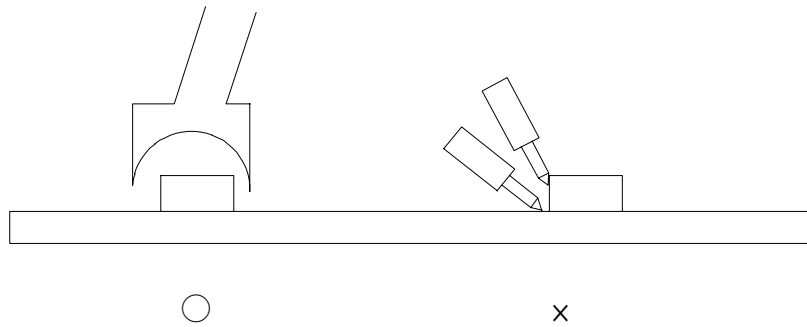
**EVERLIGHT ELECTRONICS CO., LTD.***Office: No 25, Lane 76, Sec 3, Chung Yang Rd,  
Tucheng, Taipei 236, Taiwan, R.O.C**Tel: 886-2-2267-2000, 2267-9936**Fax: 886-2267-6244, 2267-6189, 2267-6306**<http://www.everlight.com>*