

HRT 25B Long Range

Diffuse reflection sensor with background suppression

en 03-2019/04/23 50134386-02



Dimensioned drawing

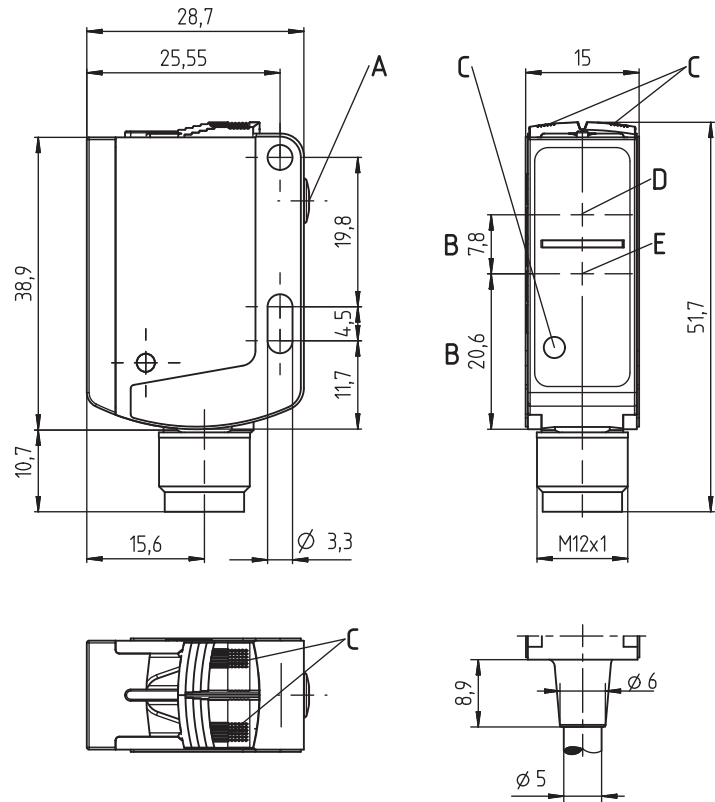

- A Teach button
- B Optical axis
- C Indicator diodes
- D Receiver
- E Transmitter

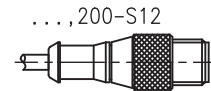

Electrical connection

Connector, 5-pin

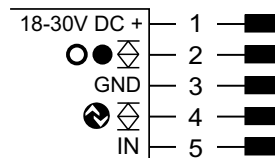

Cable, 5-wire

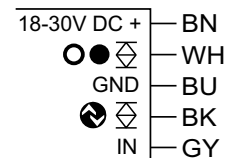

Selection pin 5 / GY conductor

IN
deactivating
n.c. (not connected)
ext. teach-in



50 ... 3000mm
 2500mm with
 black-white error < 50mm



- Small, compact infrared sensor
- Large detection range, reproducible distance determination based on time-of-flight technology
- Problem-free mechanical installation – sensor performance enables detection at unfavorable angles to the object
- Extremely simple operation, teachable switching points
- External teach input for time-saving adaptation to the application
- An additional status display on the front side of the sensor makes possible place-saving alignment, optimum range adjustment and rapid function control
- Minimal current consumption – reduction of energy consumption in standby operation
- Switching behavior independent of the entry direction



Accessories:

(available separately)

- Mounting systems
- Cable with M12 connector (KD ...)
- IO-Link master set SET MD12-US2-IL1.1 + accessories - diagnostics set (part no. 50121098)

We reserve the right to make changes • PAL_HRT25B_2500_en_50134386_02.fm

Technical data

Optical data

Typ. maximum range (white 90%) ¹⁾	50 ... 3000mm
Operating range ²⁾	50 ... 2500mm
Adjustment range (teach-in range)	150 ... 3000/2500mm (90%/4% diffuse reflection)
Light source ³⁾	LED (modulated light)
Wavelength	850nm (infrared light)
Light spot	Approx. Ø 60mm at 1m ⁴⁾ Approx. Ø 110mm at 2m ⁴⁾

Error limits

Adjustment accuracy (via IO-Link)	± 10% (300 ... 2500 mm)
Repeatability ⁵⁾	< ± 15mm
B/W detection thresh. (2 ... 90% rem.)	± 25mm
Temperature drift	± 2mm/K

Time behavior

Switching frequency	30 Hz ⁶⁾
Response time	< 70ms ⁶⁾
Readiness delay	≤ 300ms

Electrical data

Operating voltage U_B ⁷⁾	18 ... 30VDC (incl. residual ripple)
Residual ripple	≤ 15% of U_B
Open-circuit current	≤ 32mA
Switching output	.../L6... Pin 4 (Q1): IO-Link Data, in SIO mode push-pull switching output Pin 2 (Q2): Push-pull switching output ⁸⁾ , PNP light switching, NPN dark switching
Signal voltage high/low	≥ ($U_B - 2V$)/≤ 2V
Output current	Max. 50mA
IO-Link	COM2 (38.4kBaud), vers. 1.1, min. cycle time 2.3ms, SIO is supported

Indicators

Top side of sensor	
Green LED	Ready
Yellow LED	Switching output Q1 active, see tables
Sensor front	
Multicolor LED	Yellow
	Blue
	White (yellow+blue)
	Switching output Q1 active, see tables
	Switching output Q2 active, see tables
	Switching output Q1 and Q2 active, see tables

Mechanical data

Housing	Plastic (PC-ABS)
Optics cover	Plastic (PMMA)
Weight	With connector: 15g With 200mm cable and connector: 30g With 2m cable: 55g
Connection type	Cable 2m (cross section 5x0.20mm ²) Connector M12, 5-pin Cable 0.2m with connector M12, 5-pin

Environmental data

Ambient temp. (operation/storage) ⁹⁾	-30°C ... +50°C/-40°C ... +60°C
Protective circuit ¹⁰⁾	1, 2, 3
VDE protection class	III
Degree of protection	IP 66, IP 67
Light source	Exempt group (in acc. with EN 62471)
Standards applied	IEC 60947-5-2
Certifications	UL 508, C22.2 No.14-13 ^{7) 9) 11)}

Additional functions

Deactivation input	
Transmitter inactive/active	≥ 8V/≤ 2V ¹²⁾
Activation/disable delay	≥ 20ms
Input resistance	Approx. 10kΩ

- 1) Typ. max. range/adjustment range: max. achievable range/adjustment range for light objects (white 90%)
- 2) Operating range: recommended range for objects with different diffuse reflection
- 3) Average life expectancy 100,000h at an ambient temperature of 25°C
- 4) Field of view of sensor: Ø 40mm at 1m, Ø 70mm at 2m
- 5) For measurement range 50 to 2500mm, depending on diffuse reflectance and object distance, at 20°C after 20min. warmup time, medium range of U_B , measurement object ≥ 50x50mm²
- 6) Depending on diffuse reflectance
- 7) For UL applications: use is permitted exclusively in Class 2 circuits according to NEC
- 8) The push-pull switching outputs must not be connected in parallel
- 9) UL certification for a temperature range of -30°C to 60°C
- 10) 1=transient protection, 2=polarity reversal protection, 3=short circuit protection for all outputs
- 11) These proximity switches shall be used with UL Listed Cable assemblies rated 30V, 0.5A min, in the field installation, or equivalent (categories: CYJV/CYJV7 or PVVA/PVVA7)
- 12) Upon deactivation, the outputs become inactive

Observe intended use!

- ⚠ This product is not a safety sensor and is not intended as personnel protection.
- ⚠ The product may only be put into operation by competent persons.
- ⚠ Only use the product in accordance with its intended use.

Tables

Switching points ¹⁾	No reflection	Object detected
Top side of sensor		
Yellow LED Q1	Off	On
Sensor front		
	Q1<Q2	Q1>Q2
Yellow LED Q1	Off	On
Blue LED Q2	Off	On
White LED ²⁾ Q1+Q2	Off	On

- 1) Applies for object teach
- 2) LED color white = yellow + blue

Diagrams

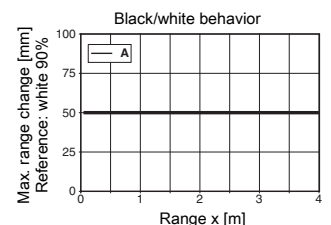
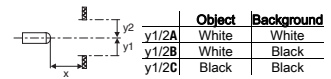
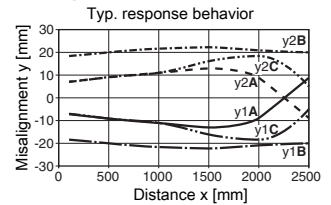

A 4% ... 90% diffuse reflection

Notes

Adjusting the switching points

- **Object teach:**
Align sensor with object.
Q1: Press teach button for approx. 2s.
Q2: Press teach button for approx. 7s
Switching point is taught.
Object is detected if the respective Q1/Q2 indicator illuminates.
- **Hysteresis:**
To ensure continuous object detection in the switching point, the sensor has a switch hysteresis.
Object is no longer detected if: distance to sensor > teach point + reserve + hysteresis.
- **Factory setting:**
Hysteresis: 30 mm (adjustable),
reserve: 30 mm (adjustable)

Application notes

- With the set detection range, a tolerance of the upper scanning range limit is possible depending on the reflection properties of the material surface.
- Range/reflectivity:

Object/diffuse reflection	
2%	0.05 ... 1.7m
90%	0.05 ... 3.0m

- Reflective, high-gloss objects (e.g. mirrors) are not detected.
- Optimum detection behavior is achieved when the light spot is fully on the object.
- The maximum possible angle relative to the object surface depends on the reflection properties.
- An only partially covered light spot can affect the detection behavior.

HRT 25B Long Range

Diffuse reflection sensor with background suppression

UL REQUIREMENTS

Enclosure Type Rating: Type 1

For Use in NFPA 79 Applications only.

Adapters providing field wiring means are available from the manufacturer. Refer to manufacturers information.

CAUTION – the use of controls or adjustments or performance of procedures other than those specified herein may result in hazardous radiation exposure.

ATTENTION! Si d'autres dispositifs d'alignement que ceux préconisés ici sont utilisés ou s'il est procédé autrement qu'indiqué, cela peut entraîner une exposition à des rayonnements et un danger pour les personnes.

Part number code

H	R	T		2	5	B	/	L	6	9	.	3	1	-	2	5	0	0	,	2	0	0	-	S	1	2
---	---	---	--	---	---	---	---	---	---	---	---	---	---	---	---	---	---	---	---	---	---	---	---	---	---	---

Operating principle

HRT Diffuse reflection sensor with background suppression

Light type

N/A Infrared light

Series

25B 25B Series

Assignment pin 4 / BK conductor

L IO-Link (with dual channel, also push/pull switching output Q1)

Assignment pin 2 / WH conductor

6 Push/pull switching output Q2

Assignment pin 5 / GY conductor

9 Deactivation input (factory setting) or teach input (> 8VDC, configurable)

6 Push/pull switching output Q3

T Teach input for external teach-in (> 8VDC, configurable)

X Do not connect

Equipment

31 Teach button for teach-in

32 Teach button for teach-in, including range adjustment via IO-Link

Range

-2500 Max. operating range 2500 mm

Electrical connection

-S12 M12 connector, 5-pin

N/A Cable, length 2000mm with wire-end sleeves, 5-wire

,200-S12 Cable, length 200mm with M12 connector, 5-pin

Order guide

The sensors listed here are preferred types; current information at www.leuze.com

	Designation	Part no.
Connection: M12 connector, 5-pin		
IO-Link 1.1/switching output, 1 push/pull switching output, deactivation input	HRT 25B/L69.31-2500-S12	50134581
IO-Link 1.1/switching output, 1 push/pull switching output, teach input	HRT 25B/L6T.31-2500-S12	50134582
IO-Link 1.1/switching output, 1 push/pull switching output	HRT 25B/L6X.31-2500-S12	50132275
IO-Link 1.1/switching output, 1 push/pull switching output, teach input, range adjustment via IO-Link	HRT 25B/L69.32-2500-S12	50142300
IO-Link 1.1/switching output, 1 push/pull switching output, teach input, range adjustment via IO-Link	HRT 25B/L6T.32-2500-S12	50142302
IO-Link 1.1/switching output, 1 push/pull switching output, teach input, range adjustment via IO-Link	HRT 25B/L6X.32-2500-S12	50142307
Connection: cable, length 2000mm with wire-end sleeves, 5-wire		
IO-Link 1.1/switching output, 1 push/pull switching output, deactivation input	HRT 25B/L69.31-2500	50134583
IO-Link 1.1/switching output, 1 push/pull switching output, teach input	HRT 25B/L6T.31-2500	50134584
IO-Link 1.1/switching output, 1 push/pull switching output	HRT 25B/L6X.31-2500	50132278
IO-Link 1.1/switching output, 1 push/pull switching output, teach input, range adjustment via IO-Link	HRT 25B/L69.32-2500	50142314
IO-Link 1.1/switching output, 1 push/pull switching output, teach input, range adjustment via IO-Link	HRT 25B/L6T.32-2500	50142316
IO-Link 1.1/switching output, 1 push/pull switching output, teach input, range adjustment via IO-Link	HRT 25B/L6X.32-2500	50142317
Accessories ¹⁾		
Mounting bracket, stainless steel	BT 200M.5	50118542
Mounting bracket, galvanized steel, 10x	BT 205M	50124651
Mounting system for mounting on rods Ø 10mm or sheet metal clamp-mounting	BTU 200M-D10	50117256
Mounting system for mounting on rods Ø 12mm or sheet metal clamp-mounting	BTU 200M-D12	50117255
Mounting system for mounting on rods Ø 14mm or sheet metal clamp-mounting	BTU 200M-D14	50117254
Connection cable with M12 connector, angled, 5-pin, length 2 m, PVC sheathing	K-D M12W-5P-2m-PVC	50104556
IO-Link master set	SET MD12-US2-IL1.1 + accessories - diagnostics set	50121098

1) Further mounting devices and connection cables available at www.leuze.com

HRT 25B Long Range

Diffuse reflection sensor with background suppression

IO-Link interface (only HRT 25B/L...)

Sensors in the HRT 25B/L... variant have a dual channel architecture. The IO-Link interface in accordance with specification 1.1.1 (October 2011) is provided on pin 4 (Q1). This allows the devices to be configured quickly and easily and, therefore, cost-effectively. Furthermore, the sensor transmits its process data and makes diagnostic information available through it.

Parallel to the IO-Link communication, the sensor can output the continuous switching signal for object detection on Q2. The IO-Link communication does not interrupt this signal.

IO-Link process data format

(IO-Link 1.1, M-sequence TYPE_2_1)

Output data device (8 bit)

Data bit								Assignment	Meaning
7	6	5	4	3	2	1	0		
								Switching output Q1	0 = inactive, 1 = active
								Switching output Q2	0 = inactive, 1 = active
								Switching output Q3	0 = inactive, 1 = active (if Q3 not present = 0)
								Measurement	0 = initialization/teach/deactivation, 1 = running measurement
								Signal	0 = no signal or signal too weak, 1 = signal ok
								Warning	0 = no warning, 1 = warning, e.g., weak signal
								0	Not assigned (initial state = 0)
								0	Not assigned (initial state = 0)

Device input data

None

Device-specific IODD

At www.leuze.com in the download area for IO-Link sensors you will find the **IODD zip file** with all data required for the installation.

IO-Link parameter documentation

A complete description of the IO-Link parameters is given in the *.html files. Please double-click one of the two language variants: ***IODD*-de.html** for **German** or ***IODD*-en.html** for **English**.

Sensor adjustment (teach) via teach button

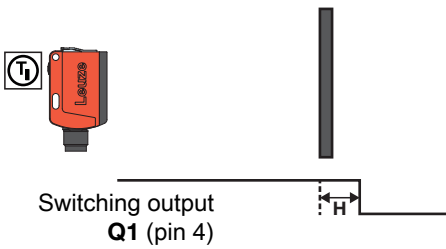
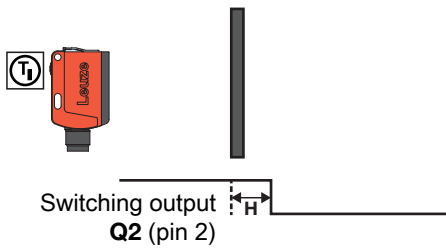
Teach	Operating level 1	Operating level 2
Teaching of two individual switching points	<p>Teach on object for Q1 (pin 4):</p> <p>With this teach mode, the switching distance for switching output Q1 is configured in such a way that the object which is in the beam path during the teach procedure is reliably detected.</p>  <p>Switching output Q1 (pin 4)</p> <p>Hysteresis H:</p> <p>To ensure continuous object detection in the switching point, the sensor has a switch hysteresis. Object is no longer detected if: distance to sensor > teach point + reserve + hysteresis.</p>	<p>Teach on object for Q2 (pin 2):</p> <p>With this teach mode, the switching distance for switching output Q2 is configured in such a way that the object which is in the beam path during the teach procedure is reliably detected.</p>  <p>Switching output Q2 (pin 2)</p>



The sensors have a factory-set hysteresis **H** of 50mm.

Operation via teach button

Teach-in on operating level 1 (switching distance for Q1)

- Press teach button until both LEDs flash simultaneously.
- Release teach button.
- Ready.

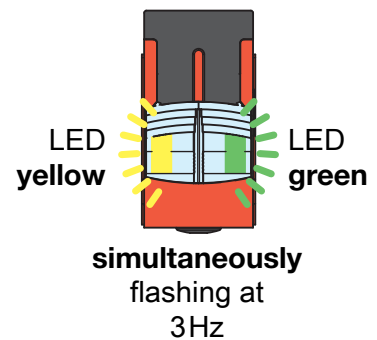
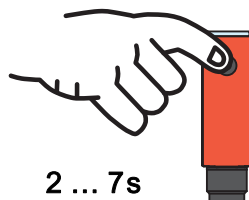

Teach-in on operating level 2 (switching distance for Q2)

- Press teach button until both LEDs flash alternately.
- Release teach button.
- Ready.

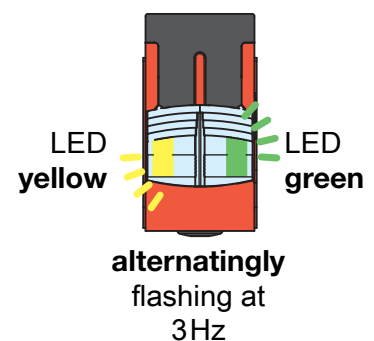
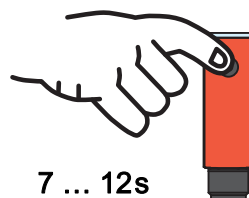

HRT 25B Long Range

Diffuse reflection sensor with background suppression

Adjusting the switching behavior of the switching output – light/dark switching

This function permits inversion of the sensors' switching logic.

- Press teach button until only the green LED flashes. Yellow LED:
ON = switching outputs light switching (in the case of complementary sensors, Q1 (pin 4) light switching, Q2 (pin 2) dark switching), this means output active when object is detected.
- OFF = switching outputs dark switching (in the case of complementary sensors, Q1 (pin 4) dark switching, Q2 (pin 2) light switching), this means output inactive when object is detected.
- Release teach button.
The yellow LED then indicates the toggled switching logic.
- Ready.

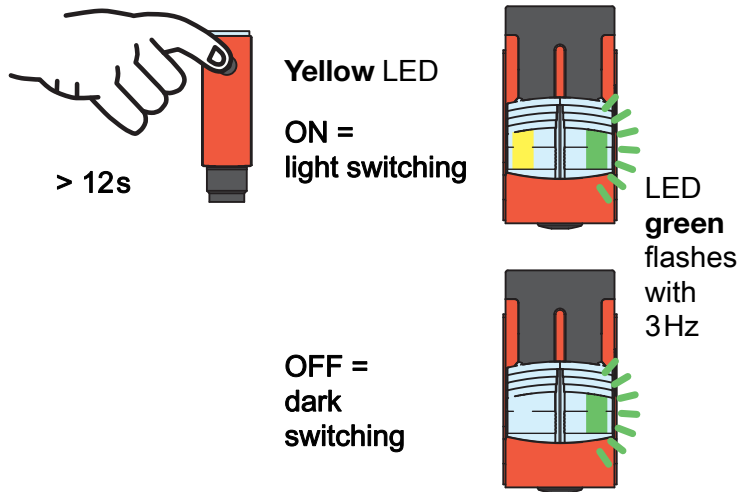

Set factory defaults

It's possible to restore the factory settings of the sensor via the teach button.

- Hold down the teach button during power-on. The green and yellow LEDs flash simultaneously at 3Hz.
- Release the teach button. The green and yellow LEDs flash alternately at 3Hz.
- Press the teach button. The green and yellow LEDs flash simultaneously at 9Hz.
- Release the teach button. The factory settings are restored and the sensor is restarted.

The sequence must be completed within 10s, otherwise the factory settings will not be restored.

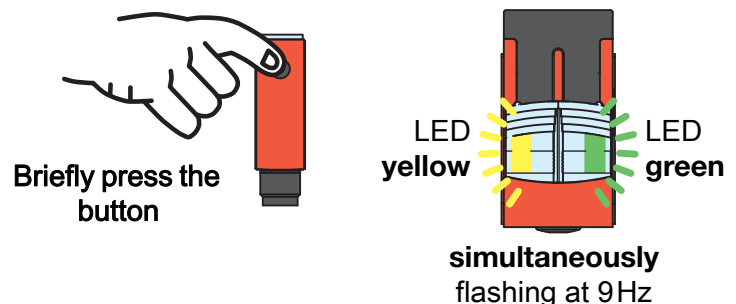
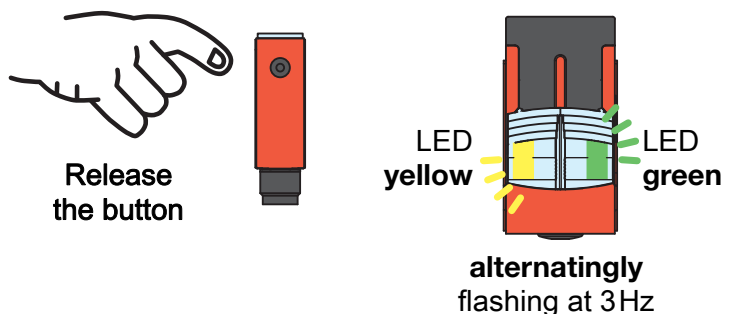
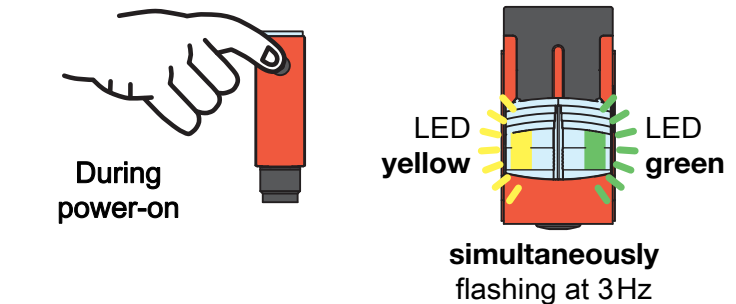

Sensor adjustment (teach) via teach input (pin 2)



The following description applies to PNP switching logic!

Signal level LOW $\leq 2V$

Signal level HIGH $\geq (U_B - 2V)$

With the NPN models, the signal levels are inverted!

Line teach on operating level 1 (switching distance for Q1)

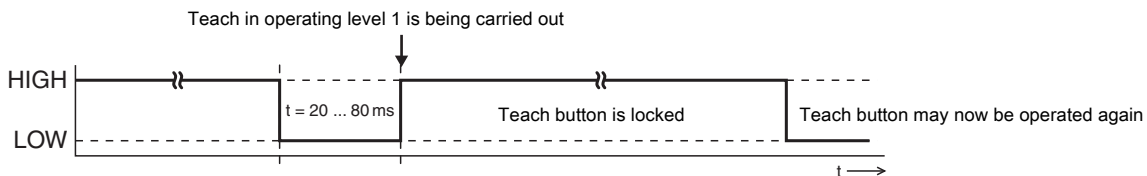

Line teach on operating level 2 (switching distance for Q2)

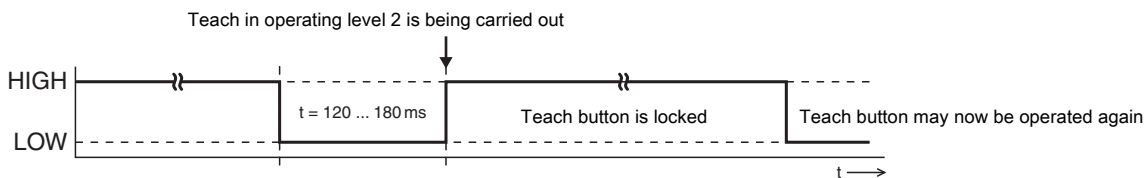

Light switching logic

Switching outputs light switching, this means outputs active when object is detected.

In the case of complementary switching outputs, Q1 (pin 4) light switching, Q2 (pin 2) dark switching.

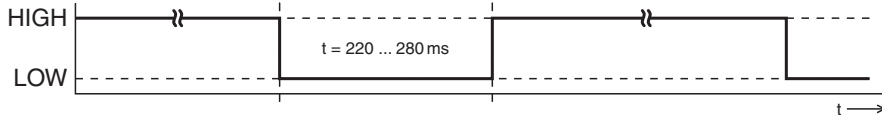

Dark switching logic

Switching outputs dark switching, this means outputs inactive when object is detected.

In the case of complementary switching outputs, Q1 (pin 4) dark switching, Q2 (pin 2) light switching.

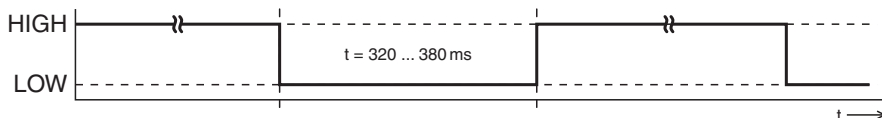

Locking the teach button via teach input (pin 2)



A **static high signal** ($\geq 20ms$) at the teach input locks the teach button on the sensor if required, such that no manual operation is possible

(e.g., protection from erroneous operation or manipulation).

If the teach input is not connected or if there is a static low signal, the button is unlocked and can be operated freely.

