

M12 male 90° / M12 male, 90°, shielded, Ethernet

PUR 2x2xAWG22 shielded rd UL/CSA+dragchain 2m

Ethernet CAT 5, D-coded

Male 90° to male 90°

M12 - M12

4-pole, shielded

Further cable lengths on request. Plastic housings with good resistance against chemicals and oils. The resistance to aggressive media should be individually tested for your application. Further details on request.

[Link to Product](#)

Illustration

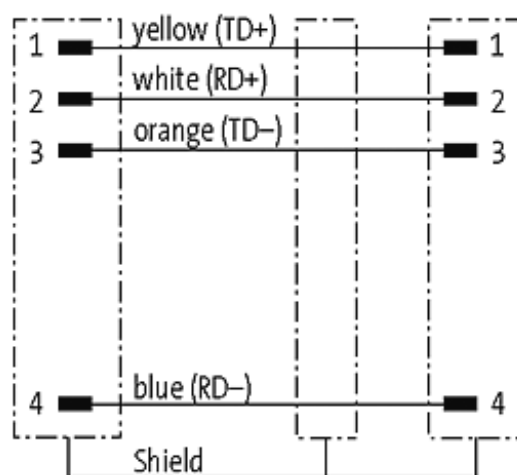

Male



Male



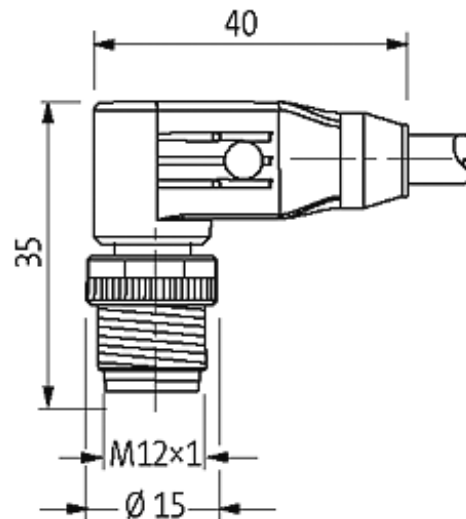

Product may differ from Image

Approvals



More Info



Form

44561

Technical Data

Operating voltage	60 V DC
Operating current per contact	max. 4 A
Locking of ports	Screw thread M12 × 1 mm (recommended torque 0.6 Nm) self-securing
Protection	IP67 inserted and tightened (EN 60529)

Cables

Cable number	792
No./diameter of wires	2 × 2 × AWG22
Wire isolation	PE (wh, ye, bl, or)
C-track properties	2 Mio.
Jacket Color	red
Shore hardness outer jacket	90 ± 5A
Material (jacket)	PUR (UL/CSA)
Outer diameter	approx. 6.7 mm

Bend radius (fixed)	5 × outer Ø
Bend radius (moving)	15 × outer Ø
Temperature range (fixed)	-40...+80 °C
Temperature range (mobile)	-20...+60 °C
Shielded	yes

Commercial data

country of origin	DE
customs tariff number	85444290
minimum order quantity	1