



TAOGLAS®



Datasheet

Pylon

Part No:
FXUB85.54.0150C

Description:

Ultra Wide Band Flex Antenna, 600MHz to 8GHz with 150mm 1.37
I-PEX MHF 4L Connector (HSC compatible)

Features:

Ultra-wide bandwidth, covering all 5G/4G/3G applications from
600 MHz – 8 GHz
Small form factor
High efficiency
Excellent radiation pattern quality
Cable: 150mm of 1.37mm coaxial cable
Connector: I-PEX MHF®4L (HSC compatible)
RoHS & Reach Compliant

1. Introduction	3
2. Specifications	4
3. Antenna Characteristics	6
4. Radiation Patterns	11
5. Mechanical Drawing	26
6. Packaging	27
7. Application Note	28
<hr/>	
Changelog	29

Taoglas makes no warranties based on the accuracy or completeness of the contents of this document and reserves the right to make changes to specifications and product descriptions at any time without notice. Taoglas reserves all rights to this document and the information contained herein. Reproduction, use or disclosure to third parties without express permission is strictly prohibited.



1. Introduction



The Taoglas Pylon FXUB85 is an ultra-wideband flexible PCB antenna designed for the next generation of connectivity. The Pylon FXUB85 provides best-in-class performance for all 5G sub 6 GHz (FR1) and Wi-Fi 6 applications. Covering the entire spectrum from 600 MHz – 8 GHz, the Pylon allows for coverage in the 3.5 GHz CBRS bands, the 1400 MHz 5G NR bands 74,75,76, and the 3.6-4.6 GHz Japan 5G NR bands 77,78,79. It maintains excellent performance in all the traditional 4G LTE bands, including 4G LTE band 71 and allows for fallback to 3G/2G bands when necessary.

The Pylon FXUB85 PCB has been expertly designed by Taoglas, to be the smallest size possible. At just 163 x 21 x 0.3mm, it can be neatly placed in the next generation of connected devices. As devices become more compact, the Pylon alleviates size constraint issues. The antenna performs well at a reasonable distance, typically 20mm, from a ground and has demonstrated ease of integration into complex end user equipment.

Typical Applications Include:

- IoT and Connected Devices
- UAVs and Autonomous Vehicles
- Precision Tracking
- Industrial Robotics and Factory Automation
- Field and Body Sensors and Wearables

The Pylon FXUB85 antenna has a typical efficiency of more than 70% across both low and high frequency bands. The Pylon is designed to be mounted directly onto a plastic or glass enclosures. It is an ideal choice for any device maker that desires ease of integration and needs to keep manufacturing costs down over the lifetime of a product without compromising performance.

The FXUB63 uses a future proof I-PEX MHF® 4L connector for 5G applications to match the many module providers new 5G modules who utilize this smaller receptacle. Cable and connector are fully customizable, contact your regional Taoglas customer support team for more information.

2. Specifications

5G/4G Bands			
Band Number	5G NR / FR1 / LTE / LTE-Advanced / WCDMA / HSPA / HSPA+ / TD-SCDMA		
	Uplink	Downlink	Covered
1	UL: 1920 to 1980	DL: 2110 to 2170	✓
2	UL: 1850 to 1910	DL: 1930 to 1990	✓
3	UL: 1710 to 1785	DL: 1805 to 1880	✓
4	UL: 1710 to 1755	DL: 2110 to 2155	✓
5	UL: 824 to 849	DL: 869 to 894	✓
7	UL: 2500 to 2570	DL: 2620 to 2690	✓
8	UL: 880 to 915	DL: 925 to 960	✓
9	UL: 1749.9 to 1784.9	DL: 1844.9 to 1879.9	✓
11	UL: 1427.9 to 1447.9	DL: 1475.9 to 1495.9	✓
12	UL: 699 to 716	DL: 729 to 746	✓
13	UL: 777 to 787	DL: 746 to 756	✓
14	UL: 788 to 798	DL: 758 to 768	✓
17	UL: 704 to 716	DL: 734 to 746	✓
18	UL: 815 to 830	DL: 860 to 875	✓
19	UL: 830 to 845	DL: 875 to 890	✓
20	UL: 832 to 862	DL: 791 to 821	✓
21	UL: 1447.9 to 1462.9	DL: 1495.9 to 1510.9	✓
22	UL: 3410 to 3490	DL: 3510 to 3590	✓
23	UL: 2000 to 2020	DL: 2180 to 2200	✓
24	UL: 1625.5 to 1660.5	DL: 1525 to 1559	✓
25	UL: 1850 to 1915	DL: 1930 to 1995	✓
26	UL: 814 to 849	DL: 859 to 894	✓
27	UL: 807 to 824	DL: 852 to 869	✓
28	UL: 703 to 748	DL: 758 to 803	✓
29	UL: - N/A	DL: 717 to 728	✓
30	UL: 2305 to 2315	DL: 2350 to 2360	✓
31	UL: 452.5 to 457.5	DL: 462.5 to 467.5	✗
32	UL: - N/A	DL: 1452 - 1496	✓
35		1850 to 1910	✓
38		2570 to 2620	✓
39		1880 to 1920	✓
40		2300 to 2400	✓
41		2496 to 2690	✓
42		3400 to 3600	✓
43		3600 to 3800	✓
48		3550 to 3700	✓
66	UL: 1710-1780	DL: 2110-2200	✓
71		617 to 698	✓
74/75/76		1427 to 1518	✓
78		3300 to 3800	✓
79		4400 to 5000	✓
85	698-716	728-746	✓

Electrical									
Band	Frequency (MHz)	Return Loss (dB)	Efficiency (%)	Average Gain (dB)	Peak Gain (dBi)	Max Input Power	Impedance	Polarization	Radiation Pattern
5G NR/4G Band 5,8,12,13,14,17,18,20,26,27,28, 29,71	617~960	-8	69	-1.7	2.1	5	50 Ω	Linear	Omni
5G NR/4G Band 21,32,74,75,76	1427~1518	-7	62	-2.1	2.4				
4G/3G Band 1,2,3,4,9,23,25,35,39,66	1710~2200	-6	65	-1.9	1.9				
4G/3G Band 7,30,38,40,41	2300~2690	-8	62	-2.1	1.8				
5G NR/4G Band 22,42,43,48,77,78,79	3300~5000	-15	80	-1	5.3				
LTE5200/ Wi-Fi 5800	5150~5925	-11	72	-1.4	5.6				
Wi-Fi 6	5925~7125	-8	59	-2.3	4.5				

Mechanical	
Dimensions	163 x 21 x .3mm
Connector	I-PEX MHF 4L Connector (HSC compatible)
Cable	150mm of 1.37 mm Coax
Weight	1.9 g

Environmental	
Operation Temperature	-40°C to 85°C
Storage Temperature	-40°C to 85°C
Relative Humidity	Non-condensing 65°C 95% RH
RoHs & REACH Compliant	Yes

*All testing done on 1.5mm of Polycarbonate Plastic
 *Cable and connector are fully customizable

3. Antenna Characteristics

3.1 Return Loss

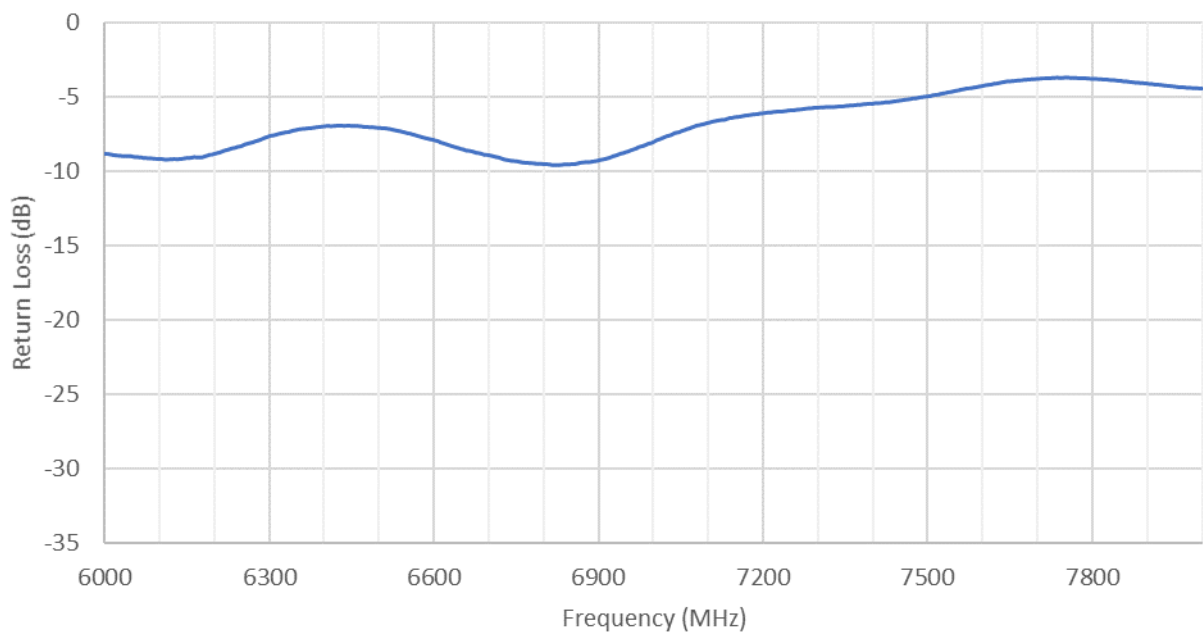

3.2 Efficiency

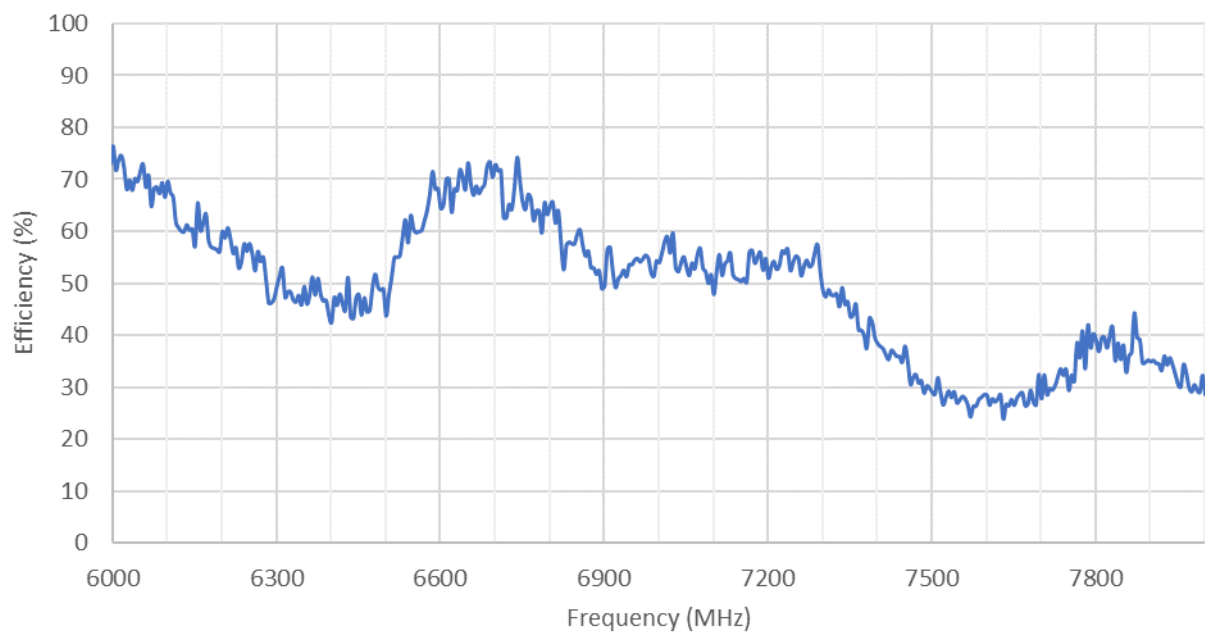
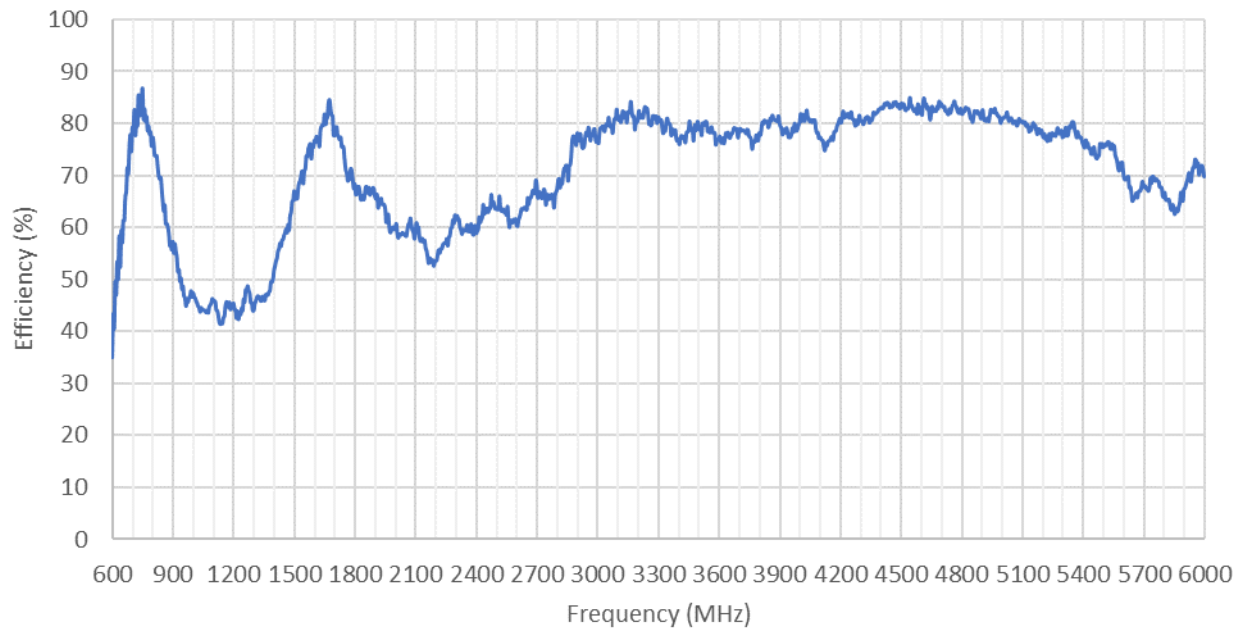

3.3 Average Gain

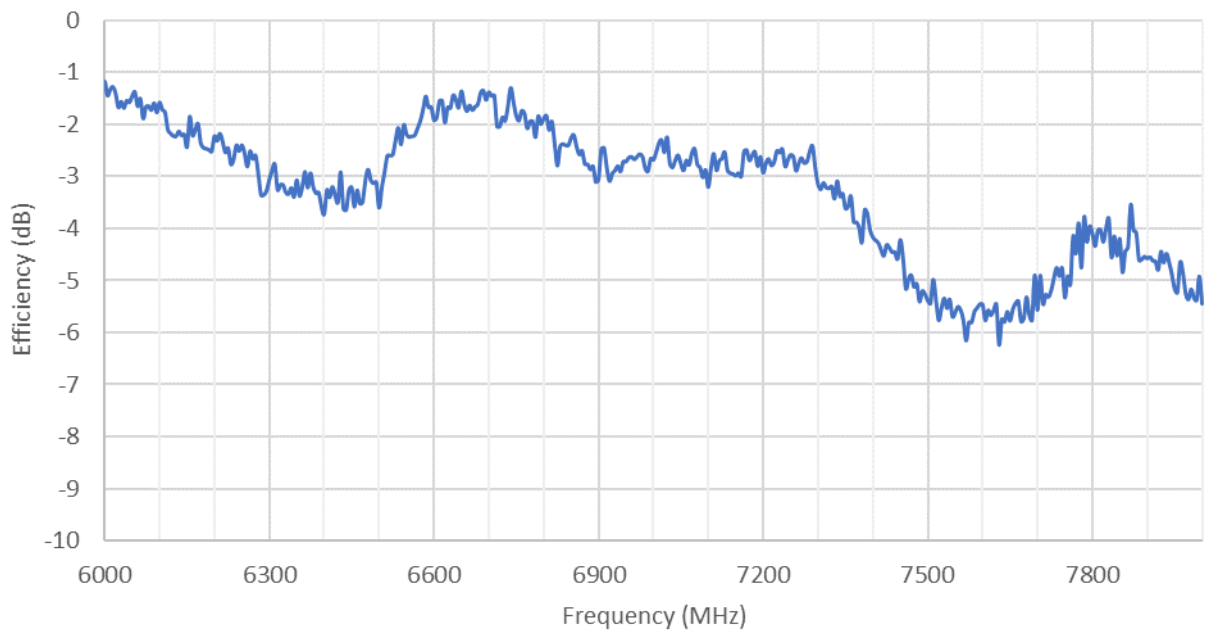
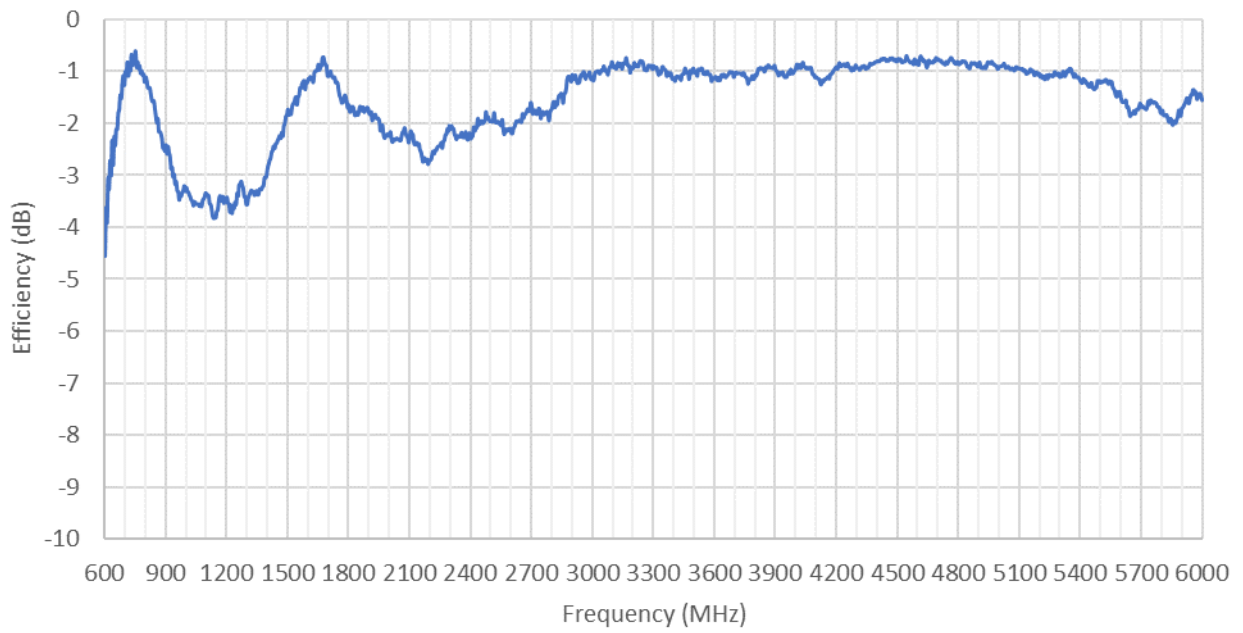

3.4 Peak Gain

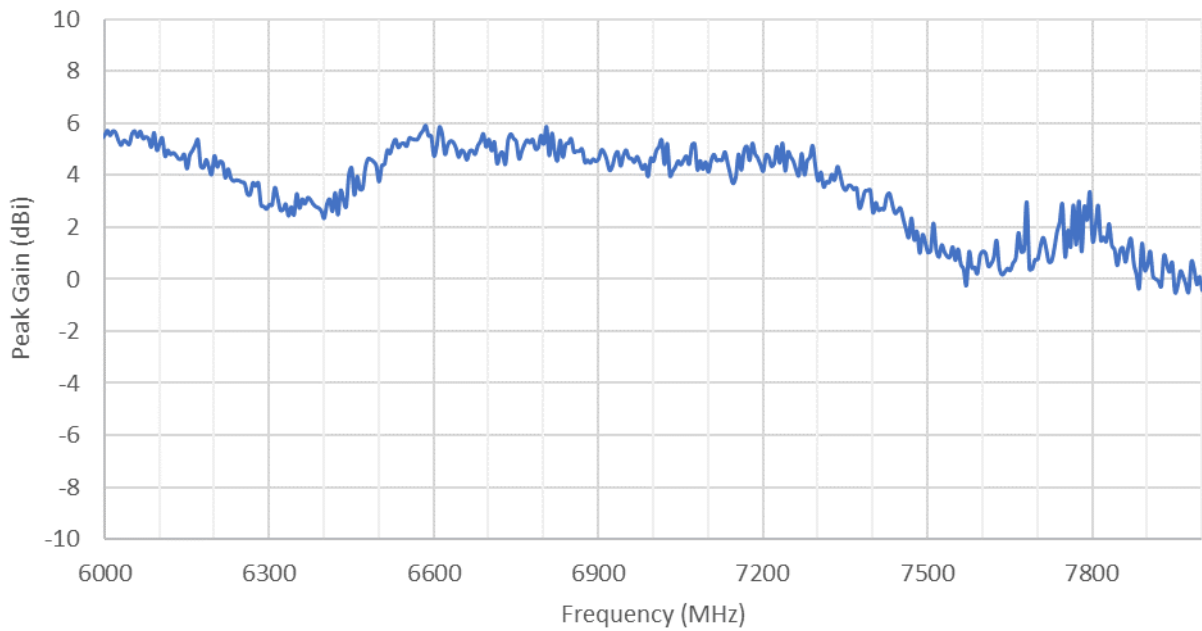
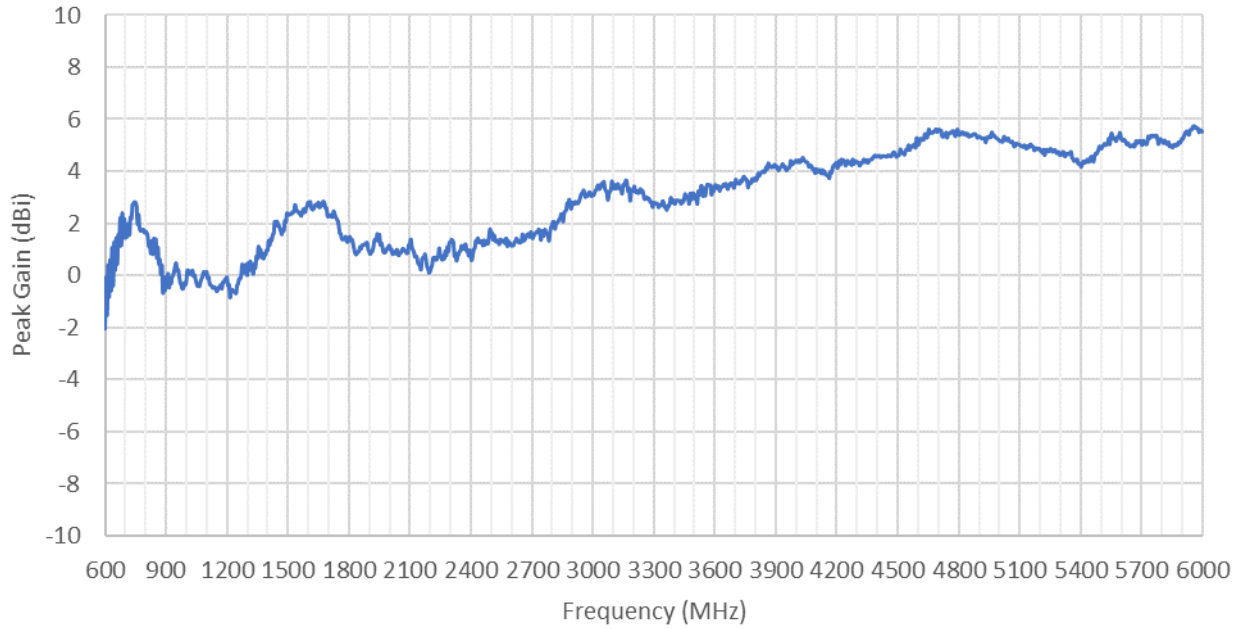

3.5 VSWR

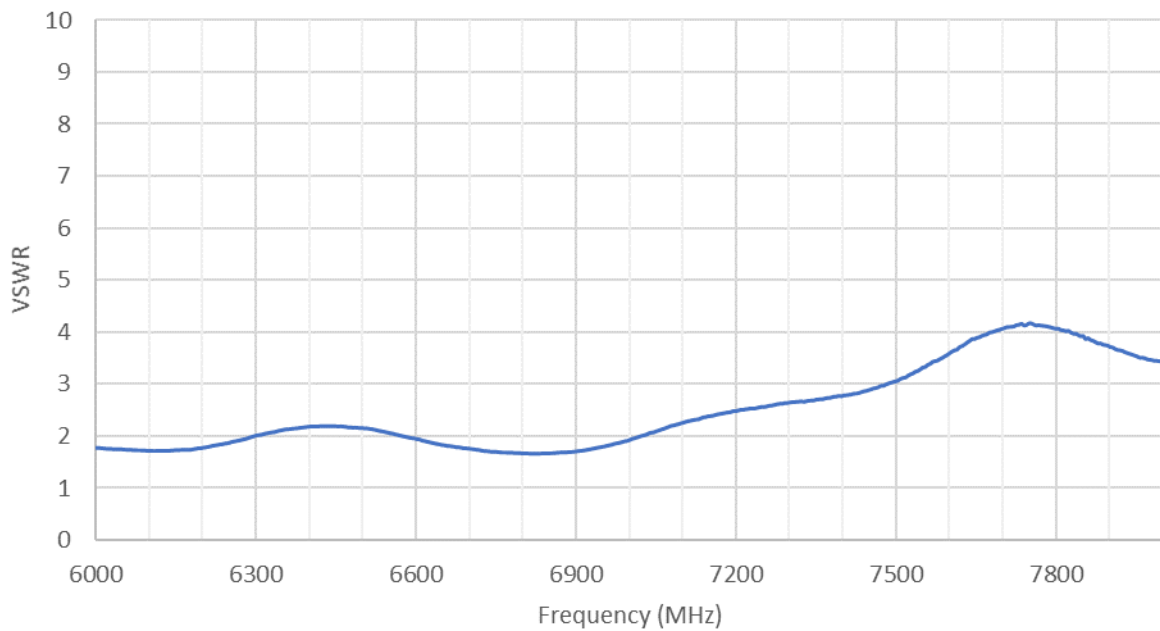
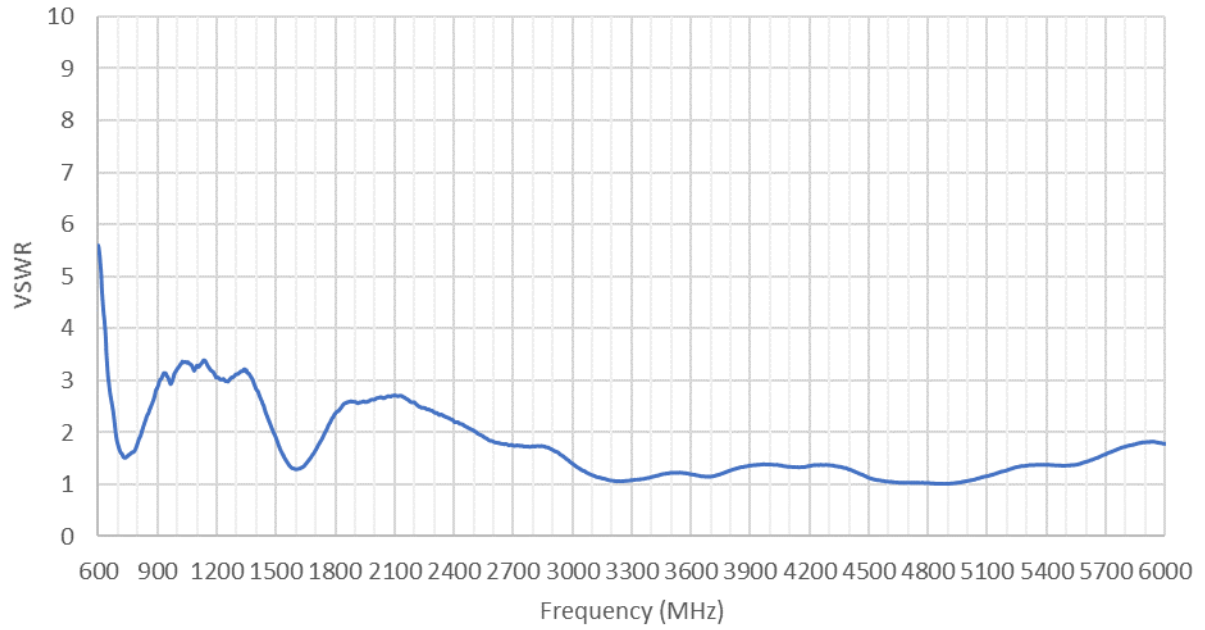

4. Radiation Patterns

4.1 Test Set-Up

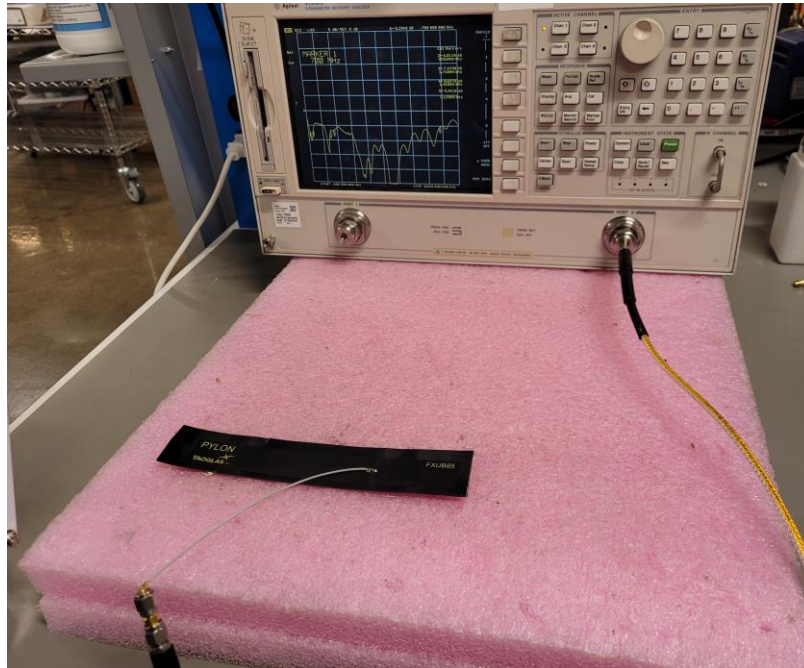

Return loss Test Setup of the FXUB85.54.0150C



OTA Setup of the FXUB85.54.0150C in the SG24-L Satimo Test System
For 600 MHz – 6 GHz Testing

OTA Setup of the FXUB85.54.0150C in the ETS AMS-8500 Test System
For 6 GHz – 8 GHz Testing

4.2 2D and 3D Radiation Patterns

650 MHz

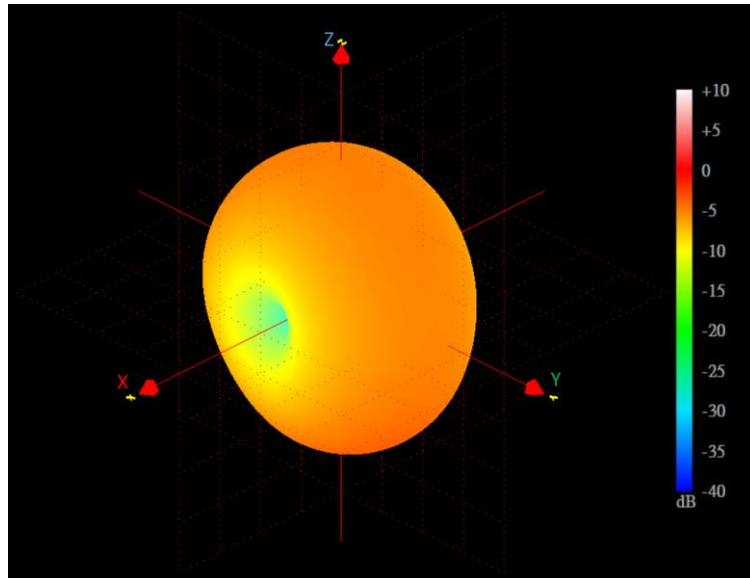

XY Plane XZ Plane YZ Plane

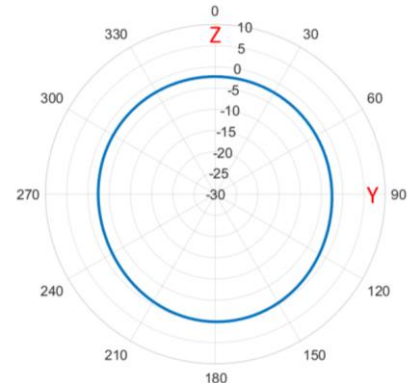
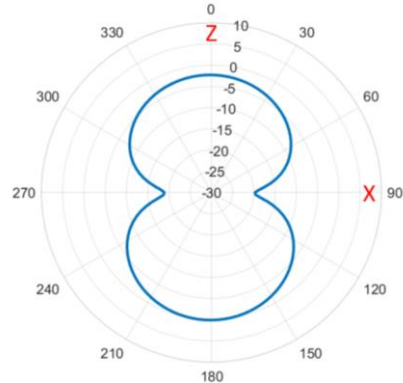
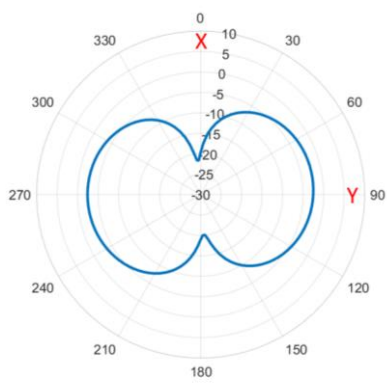

750 MHz

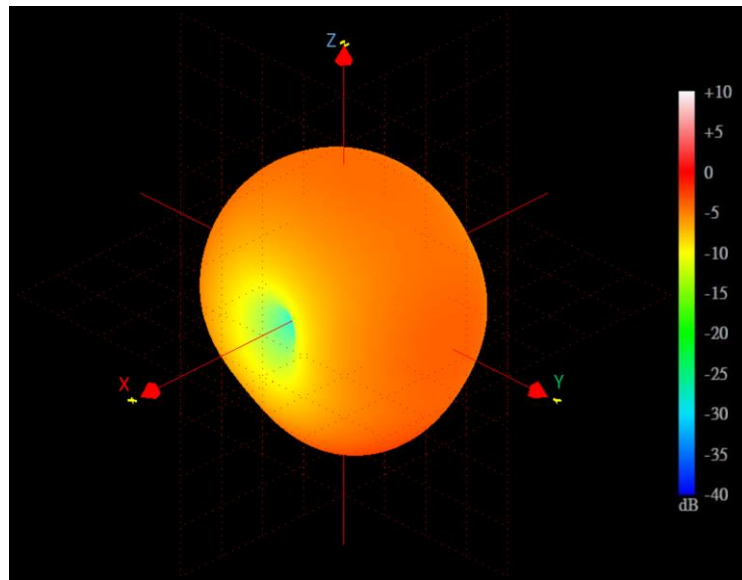

XY Plane

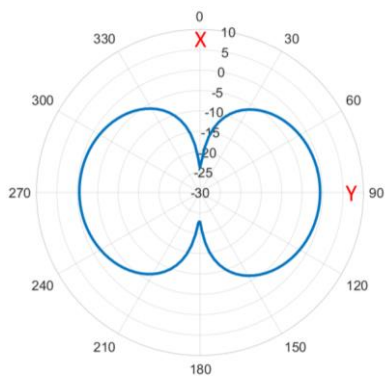

XZ Plane

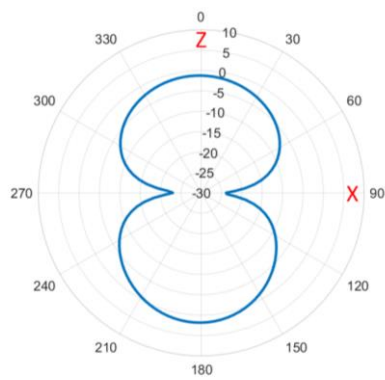

YZ Plane

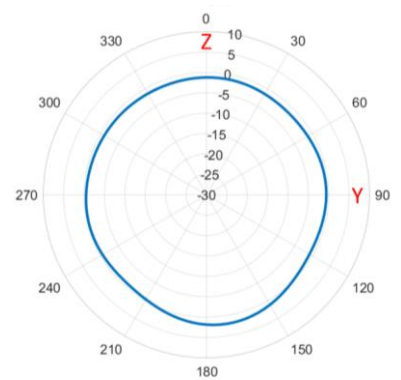

850 MHz

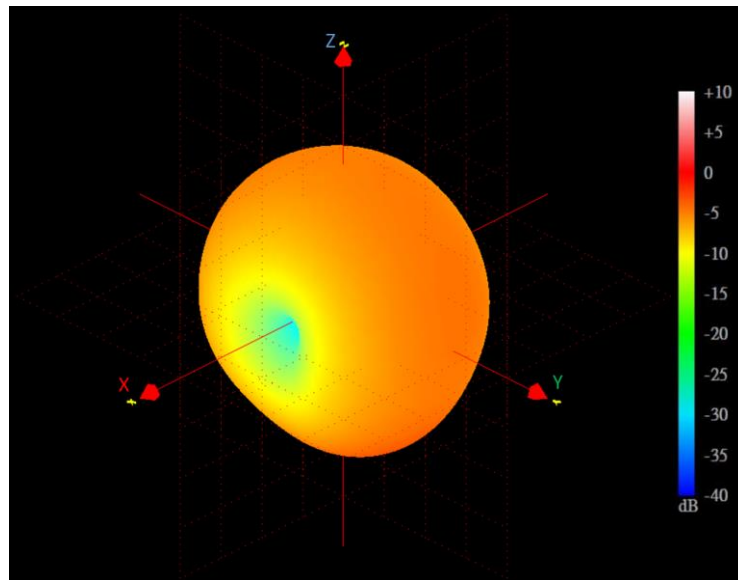

XY Plane

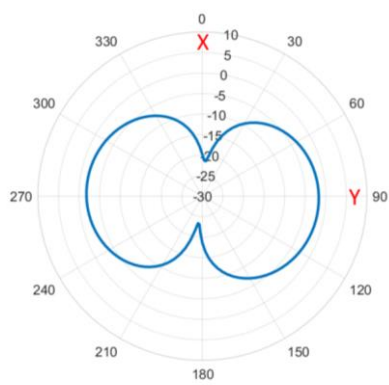

XZ Plane

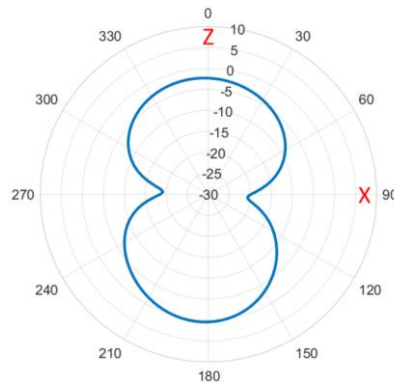

YZ Plane

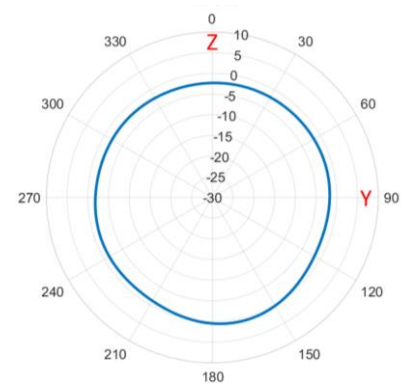

1470 MHz

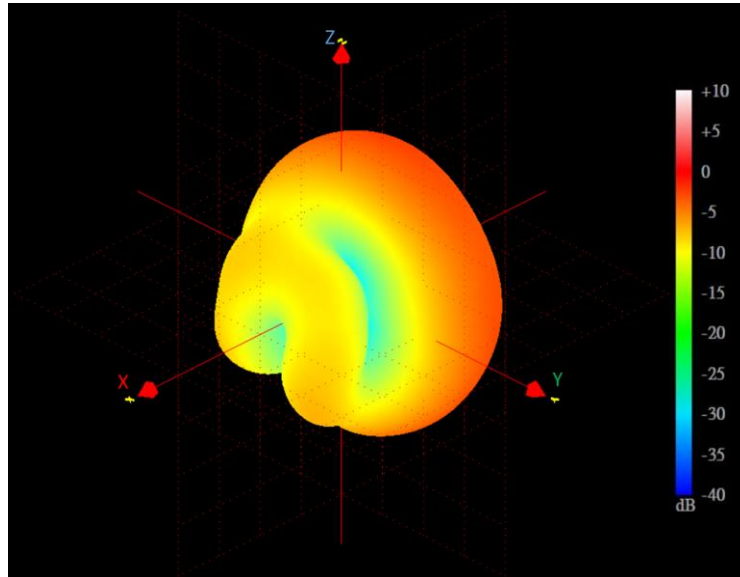

XY Plane

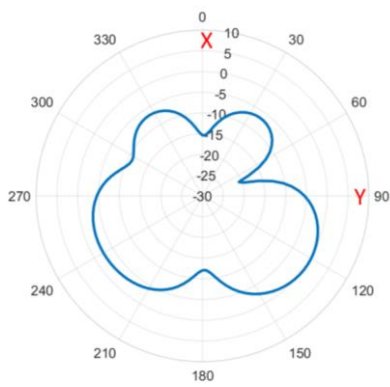

XZ Plane

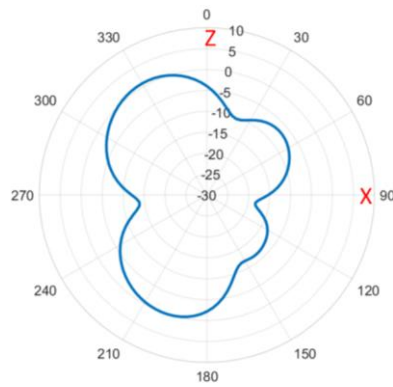

YZ Plane

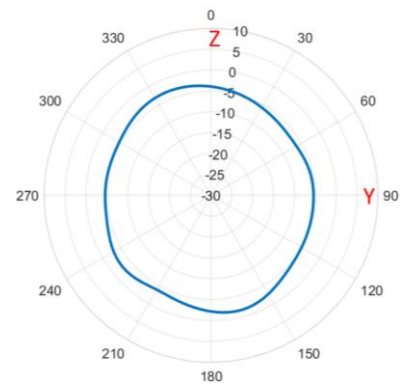

1575 MHz

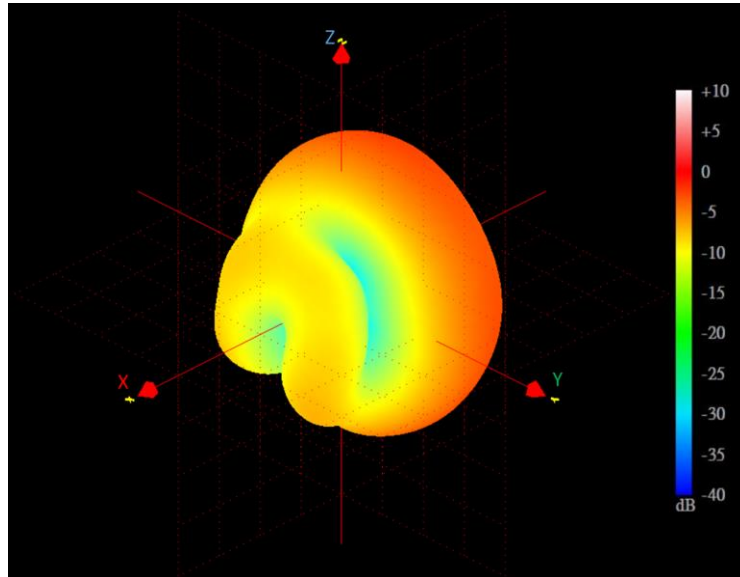

XY Plane

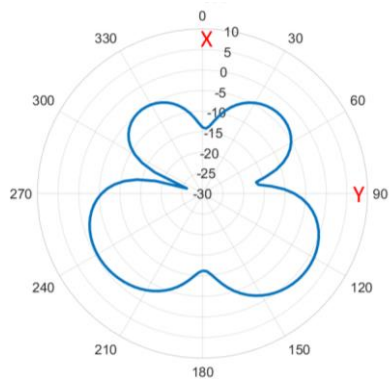

XZ Plane

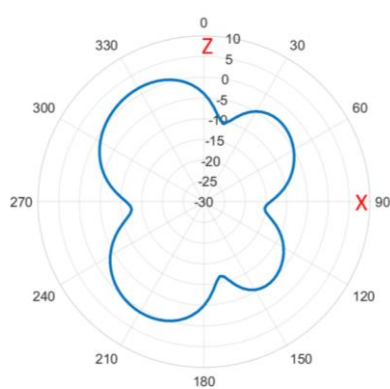

YZ Plane

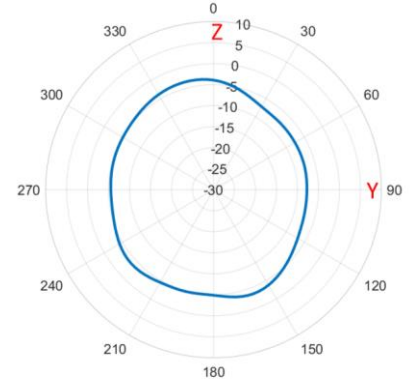

1850 MHz

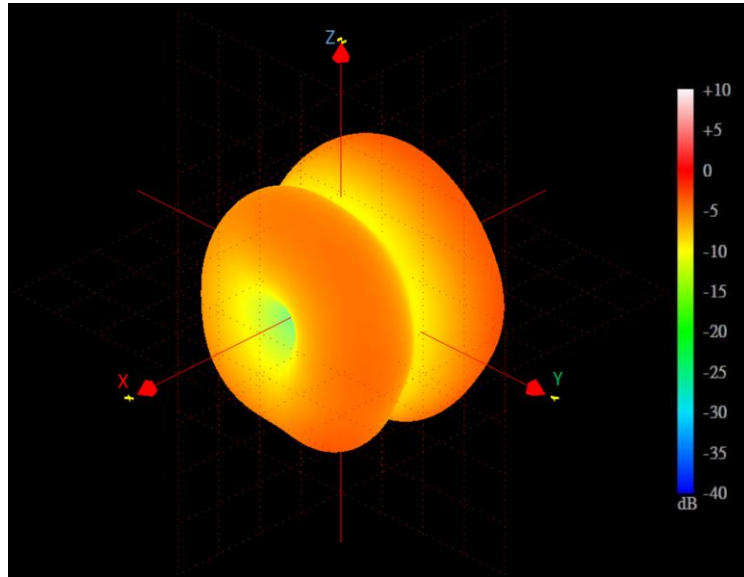

XY Plane

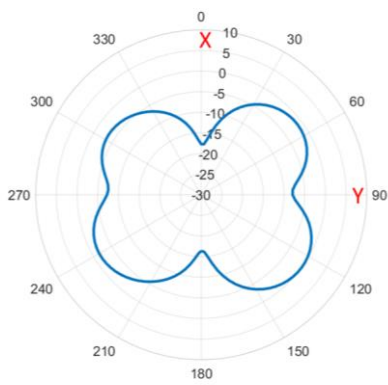

XZ Plane

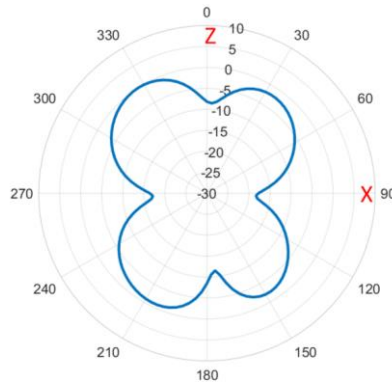

YZ Plane

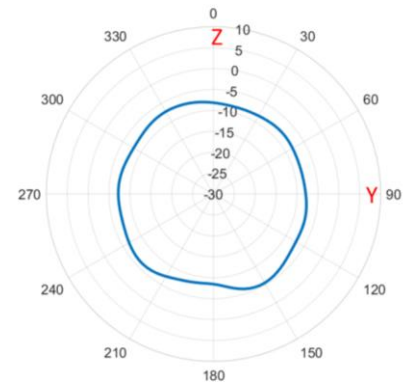

1850 MHz

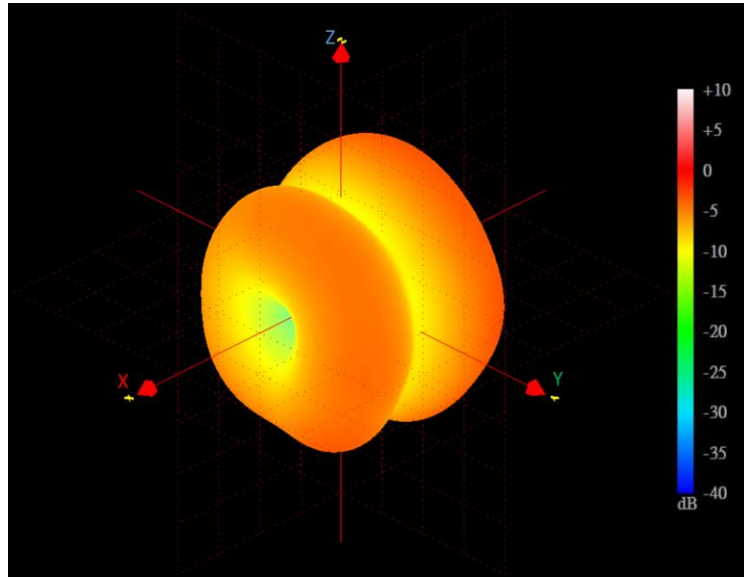

XY Plane

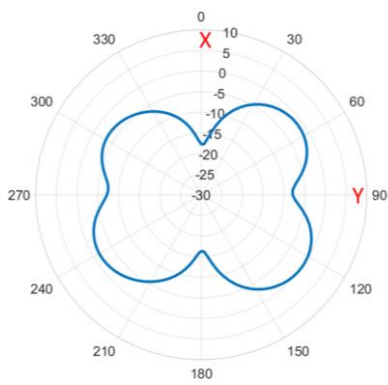

XZ Plane

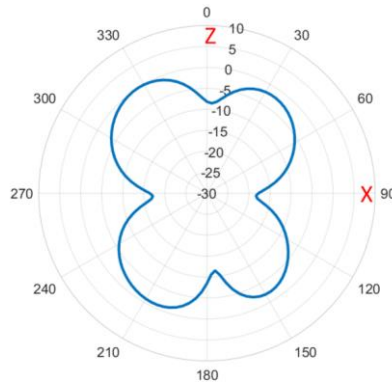

YZ Plane

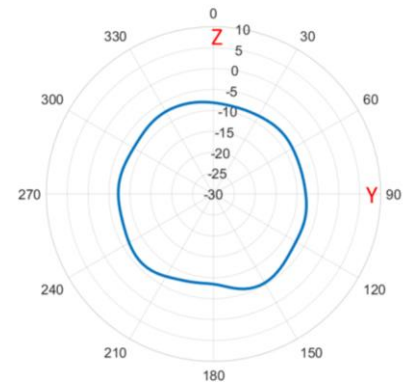

2155 MHz

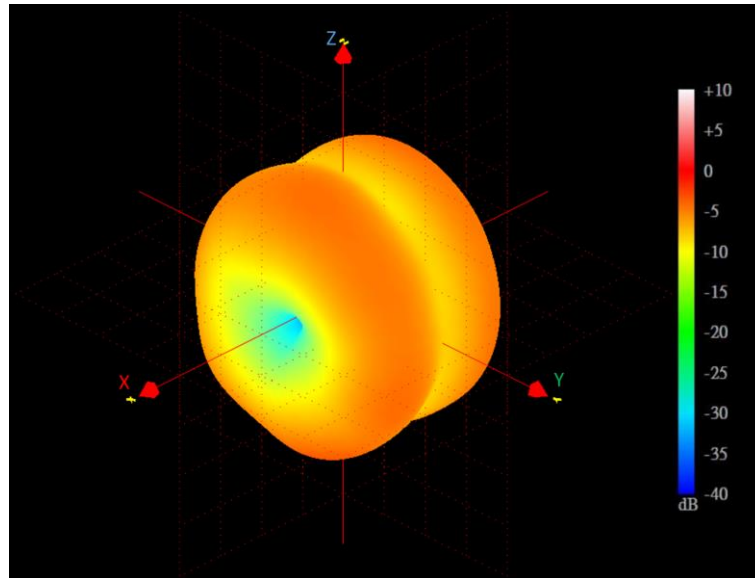

XY Plane

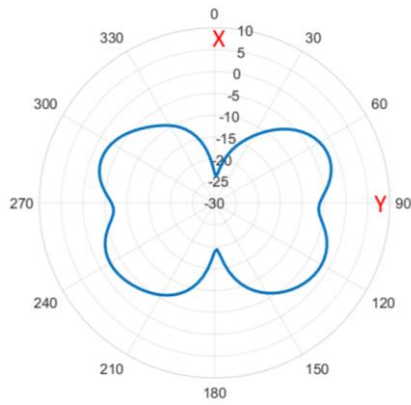

XZ Plane

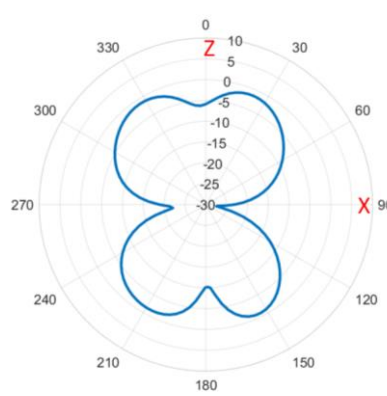

YZ Plane

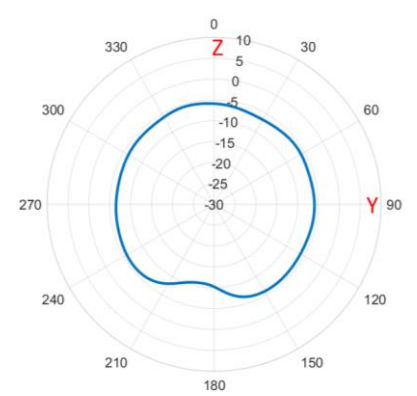

2450 MHz

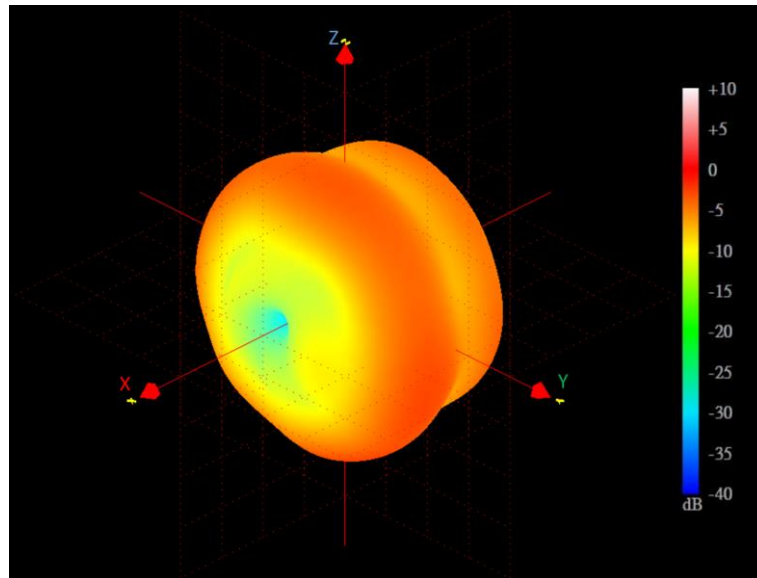

XY Plane

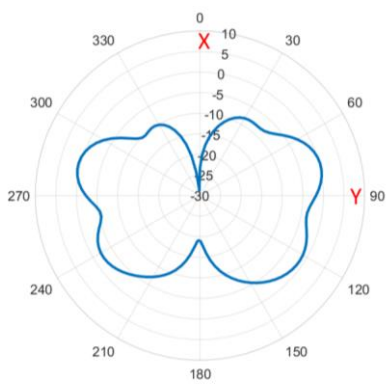

XZ Plane

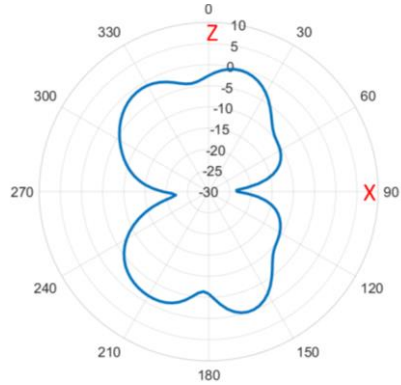

YZ Plane

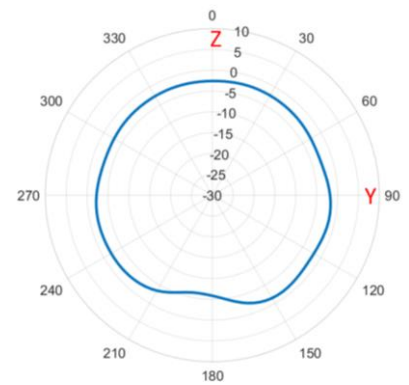

2700 MHz

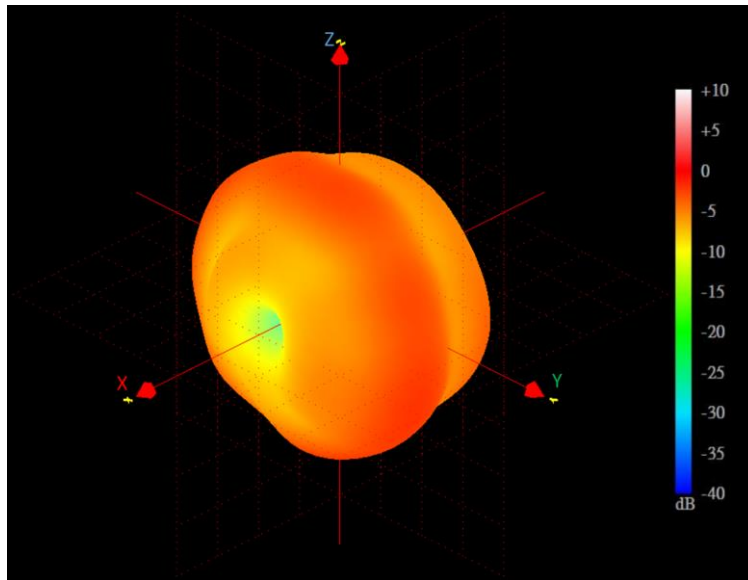

XY Plane

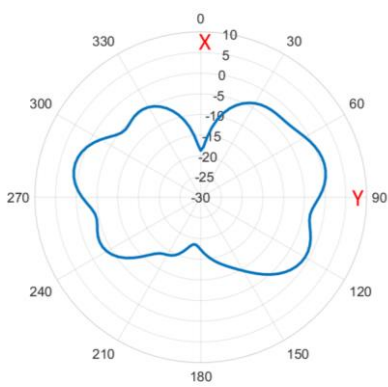

XZ Plane

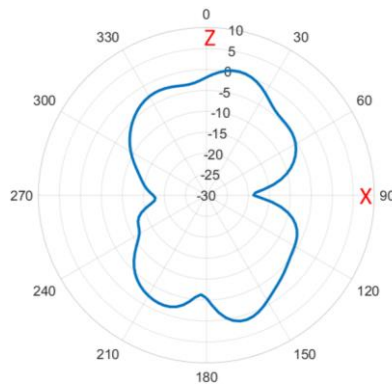

YZ Plane

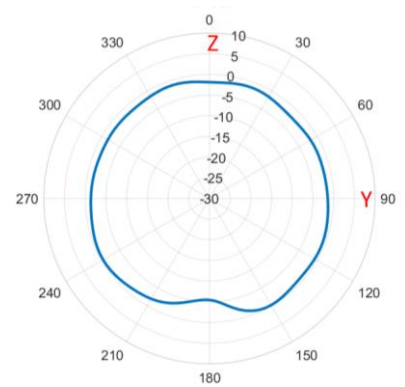

3400 MHz

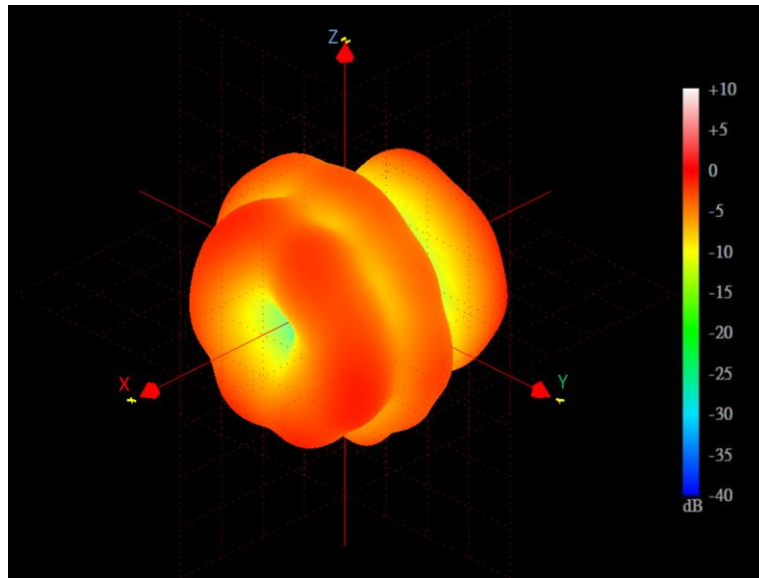

XY Plane

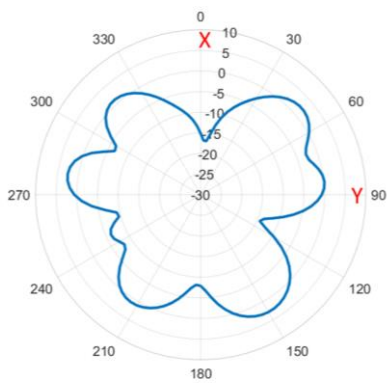

XZ Plane

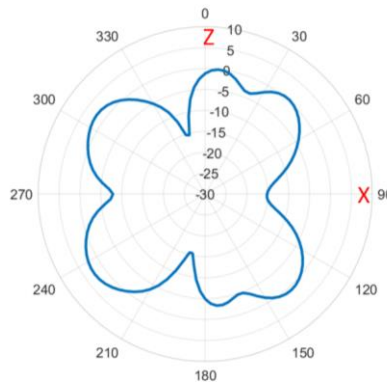

YZ Plane

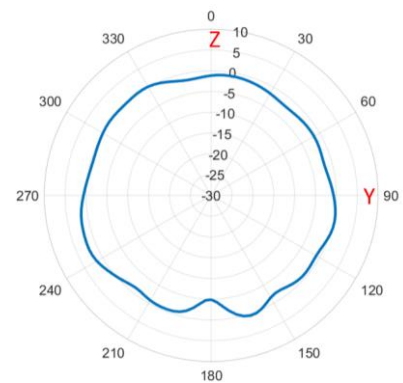

4100 MHz

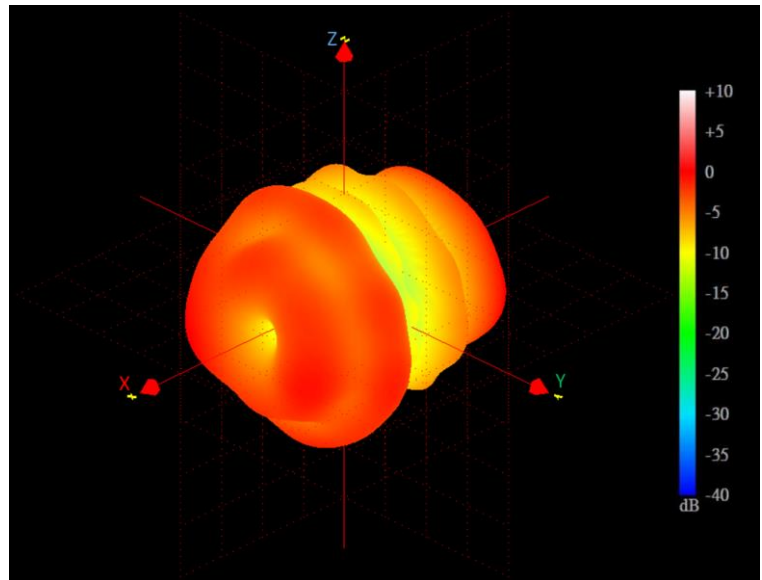

XY Plane

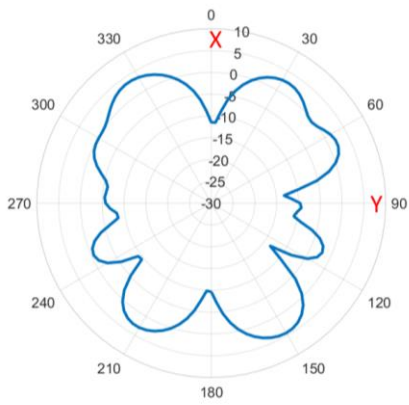

XZ Plane

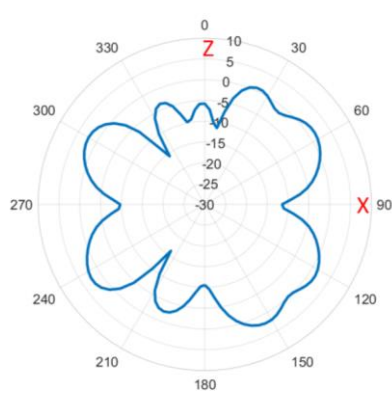

YZ Plane

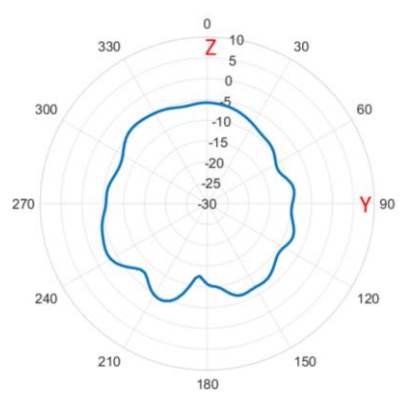

5500 MHz

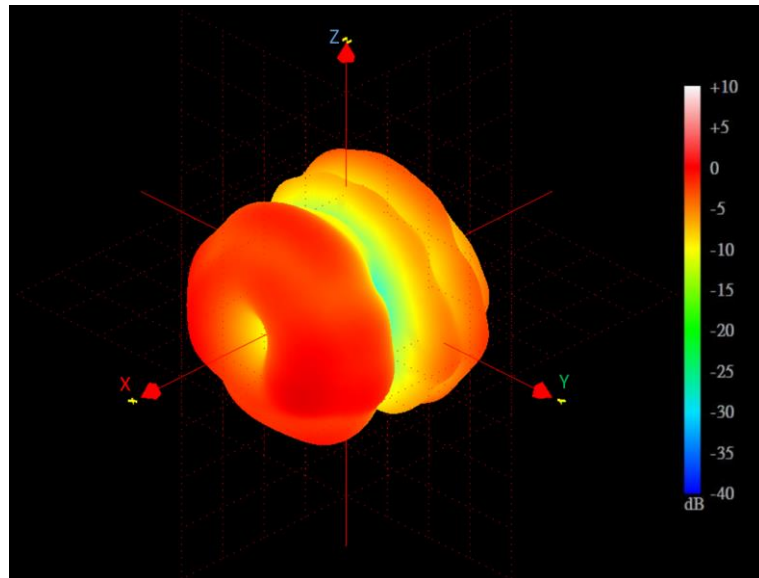

XY Plane

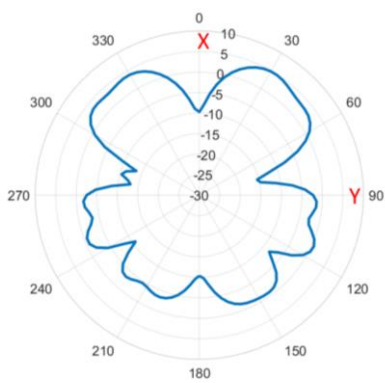

XZ Plane

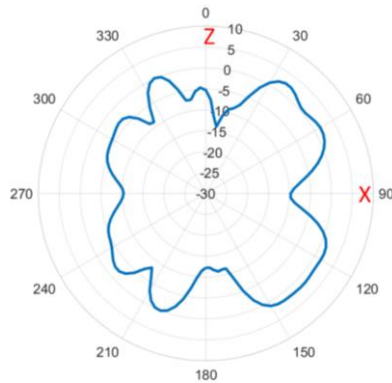

YZ Plane

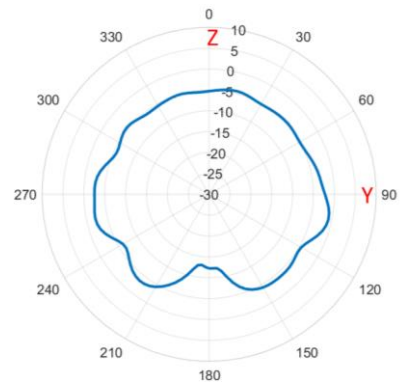

6525 MHz

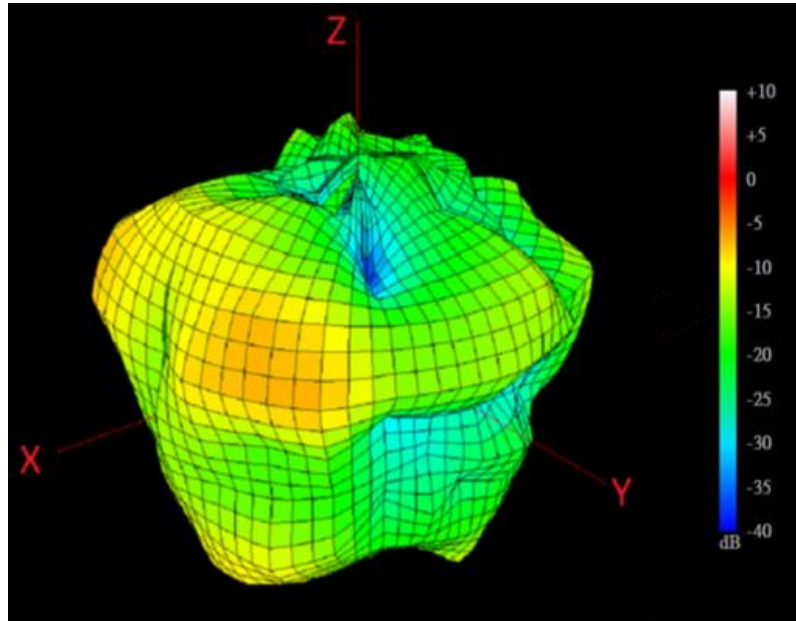

XY Plane

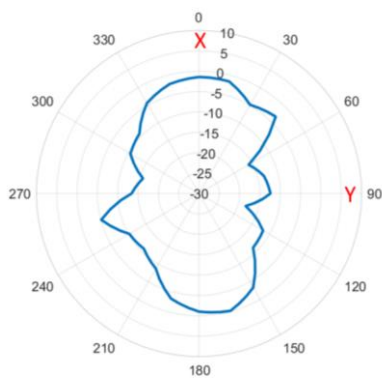

XZ Plane

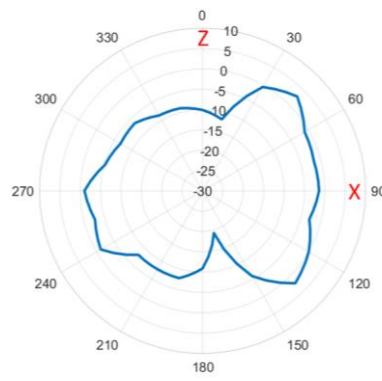

YZ Plane

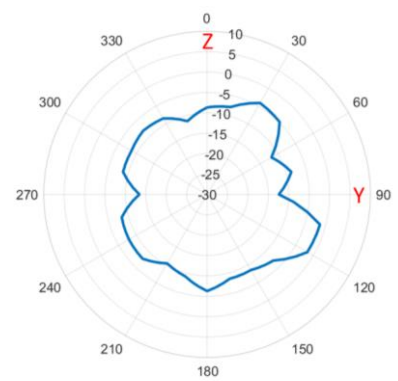

5. Mechanical Drawing (Units: mm)

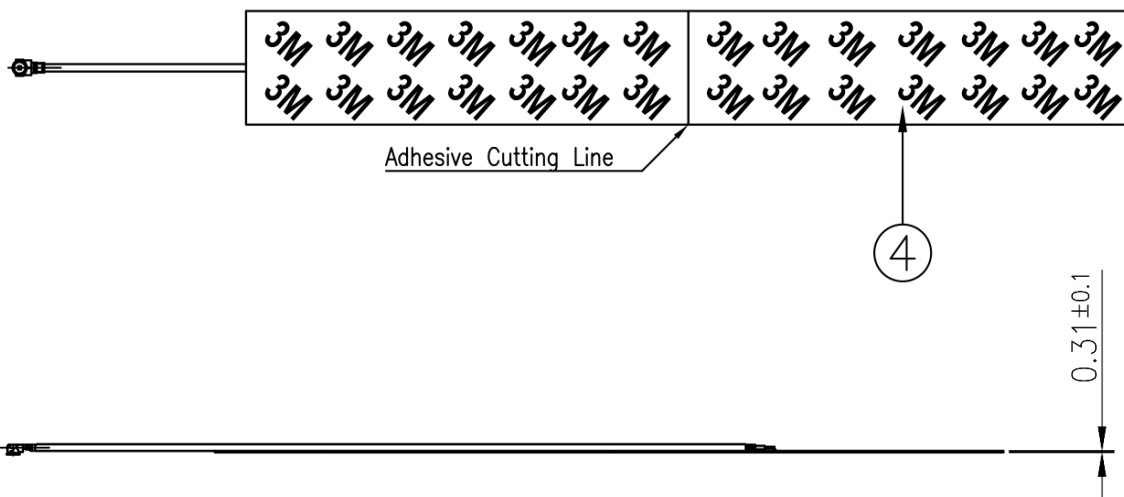
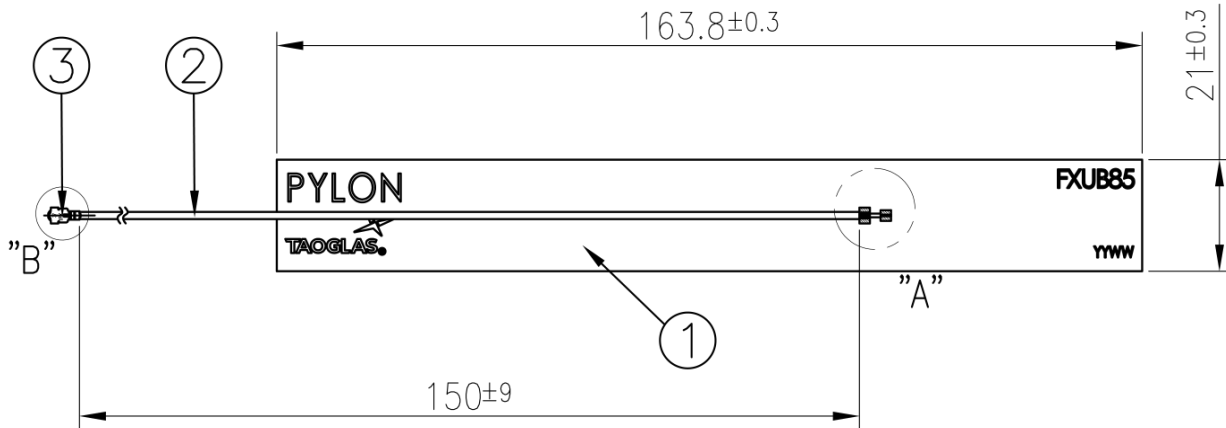

	Name	Material	Finish	QTY
1	FXUB85 FPCB	Polymer 0.31t	Black	1
2	1.37 Coaxial Cable	FEP	Gray	1
3	IPEX MHFHT	Brass	Au Plated	1
4	Double-Sided Adhesive	3M 467MP	Brown Liner	1

IPEX_MHFHT

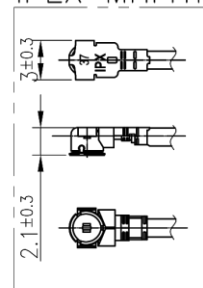

Detail B
Scale:4:1

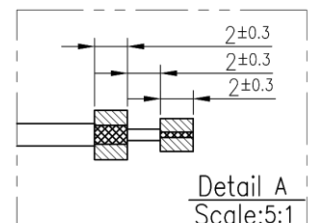

Detail A
Scale:5:1

6. Packaging

10pcs FXUB85.54.0150C per PE Bag
Weight - 20 g

100 pcs FXUB85.54.0150C per PE Bag
Weight - 200g

5000 pcs FXUB85.54.0150C per Carton
Carton Dimensions - 330 x 280 x 270mm
Weight - 10Kg

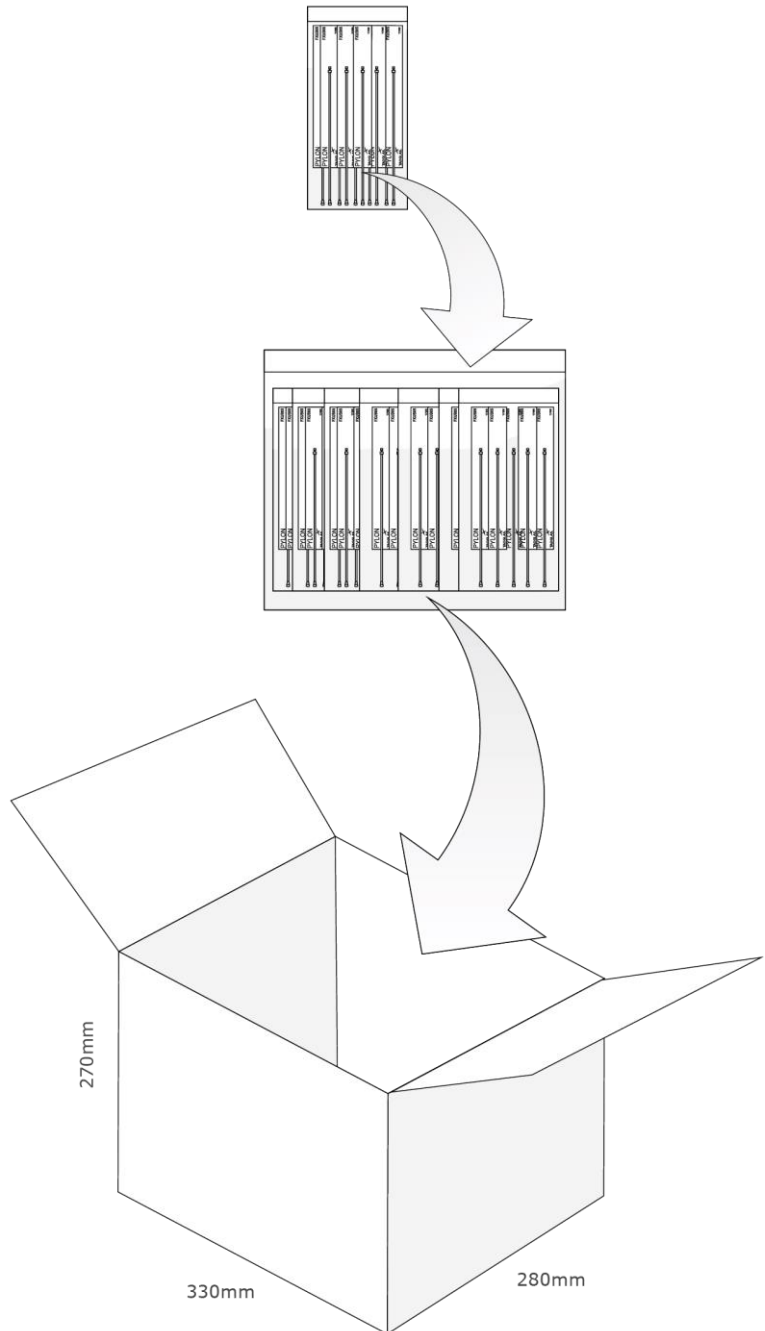

7. Application Note

Like all flex antennas, the FXUB85 Pylon antenna performance is somewhat sensitive to the routing of the cable during integration. The preferred routing is to the right, as shown in the photo below. All data presented here was taken in the “Preferred” configuration.

Routing the cable to the left also works, but routing the cable down the centre along the ground plane of the antenna is suboptimal.



Changelog for the datasheet

SPE-21-8-020 - FXUB85.54.0150C

Revision: A (Original First Release)

Date:	2021-03-25
Changes:	First Release
Changes Made by:	Gary West

Previous Revisions



www.taoglas.com

