



TAOGLAS®



Datasheet

Part No:
ADFGP.25E.07.0060A

Description:

Embedded GPS/GLONASS/BeiDou/Galileo Dual Pin Active Patch Antenna with 60mm of 1.13 Grey Microcoax & IPEX MHFI (U.FL Compatible)

Features:

Embedded Dual-Pin Patch for Lowest Axial Ratio

Covering Bands:

- GPS L1
- GLONASS L1CR & L1PT
- Galileo E2 & L1
- BeiDou B1

Cable: 60mm of 1.13mm

Connector: IPEX MHFI (U.FL Compatible)

Dimensions: 25 x 25 x 7.5mm

Tuned for Free Space

RoHS & Reach Compliant

1. Introduction	3
2. Specifications	5
3. Antenna Characteristics	8
4. Radiation Patterns	11
5. LNA Characteristics	14
6. Mechanical Drawing	16
7. Packaging	17
<hr/>	
Changelog	18

Taoglas makes no warranties based on the accuracy or completeness of the contents of this document and reserves the right to make changes to specifications and product descriptions at any time without notice. Taoglas reserves all rights to this document and the information contained herein. Reproduction, use or disclosure to third parties without express permission is strictly prohibited.



1. Introduction



The ADFGP.25E is an embedded patch antenna covering 1559MHz to 1610MHz. It has a dual feed, active patch design which makes it ideal for next-generation GNSS devices that require excellent positional accuracy in a small factor. The active patch antenna, by means of a double resonance design, has a wide-band operation over GNSS systems including GPS (L1), GLONASS (G1), Galileo (E1) and BeiDou(B1). The 25 mm patch uses a dual-feed configuration that combines both feeds with a 90° hybrid coupler to obtain an optimal axial ratio.

The ADFGP.25E includes an LNA and front-end SAW filter to reduce out of band noise, such as from nearby cellular transceivers. It offers better protection from nearby radiated power surges and greatly reduces the probability of damaging your GNSS receiver from nearby transmissions. The ADFGP.25E is manufactured and tested in a TS16949 first tier automotive approved facility.

The antenna is supplied with Ø1.13 cable and an IPEX MHFI (U.FL compatible) connector. The patch, the PCB (ground plane), the LNA, and front-end SAW components are all integrated into a form factor of just 25.1 x 25.1 x 7.5 mm. It connects via a 60mm Ø1.13 coaxial cable and IPEX MHFI connector.

Features:

- Compact Dual Feed Patch Antenna
- Excellent signal to noise ratio (C/N0)
- Good 2DRMS and fast TFFF
- Axial ratio < 5dB typ. across all bands

Benefits:

- Excellent positional accuracy
- Great for use in difficult environments
- Excellent out-of-band signal rejection
- Ideal antenna solution for RTK systems.

Typical applications include:

- High accuracy positioning and navigation systems
- UAVs, Robotics & Autonomous Vehicles
- Micro-Mobility Solutions
- Mapping & GIS
- Transportation & Telematics
- Precision Agriculture
- Public Safety, Search & Rescue
- RTK Systems

This antenna has been tuned for Free space, we also provide a version of this with a 70*70mm ground plane: ADFGP.25A.07.0060A. Custom antenna modifications are subject to possible NRE and minimum order quantity. For further information or support to test and integrate Taoglas Sure technology please contact your regional Taoglas customer support team.

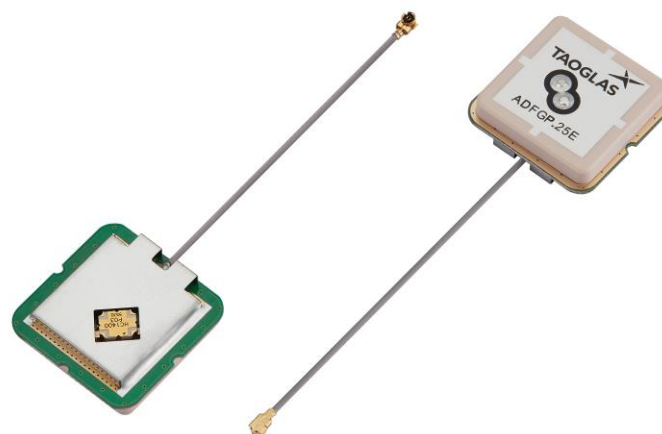

2. Specifications

GNSS Frequency Bands Covered						
GPS	L1	L2	L5			
	■	□	□			
GLONASS	G1	G2	G3			
	■	□	□			
Galileo	E1	E5a	E5b	E6		
	■	□	□	□		
BeiDou	B1	B2a	B2b	B3		
	■	□	□	□		
QZSS (Regional)	L1	L2C	L5	L6		
	■	□	□	□		
IRNSS (Regional)	L5					
	□					
SBAS	L1/E1/B1	L5/B2a/E5a	G1	G2	G3	
	■	□	■	□	□	

■ GNSS Frequency Bands Covered. □ GNSS Frequency Bands Not Covered.

*SBAS systems: WASS(L1/L5), EGNOS(E1/E5a), SDCM(G1/G2/G3), SNAS(B1,B2a), GAGAN(L1/L5), QZSS(L1/L5), KAZZ(L1/L5).

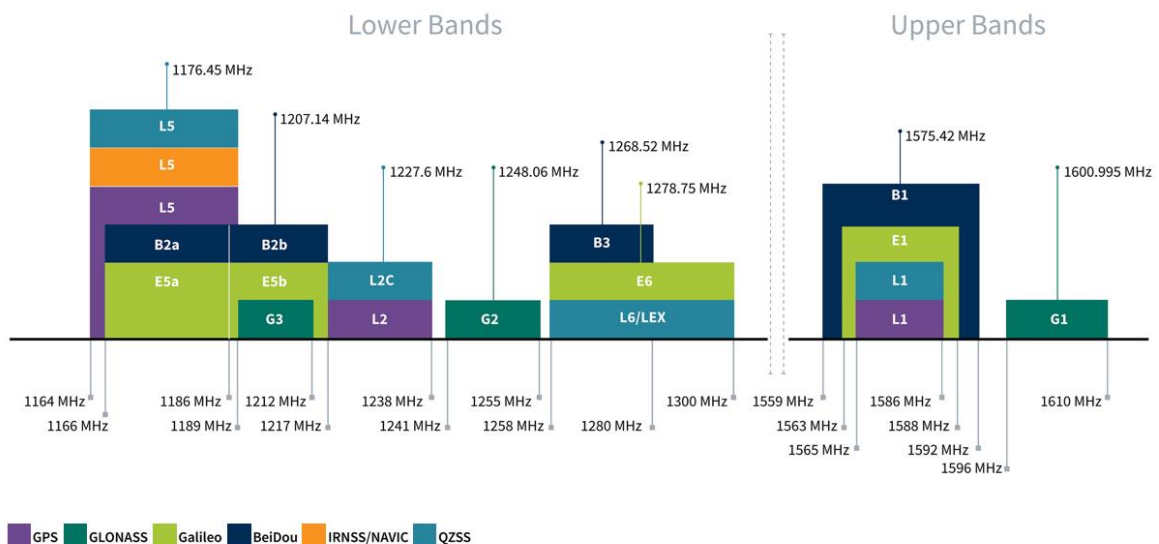

GNSS Bands and Constellations

GNSS Electrical			
Frequency (MHz)	1561	1575.42	1602
VSWR (max.)	2.0:1	2.0:1	2.0:1
Efficiency (%)	20.4	34.6	29
Peak Gain at Zenith (dBi)	-1.9	0.5	-0.8
Average Gain (dB)	-6.8	-4.6	--5.4
Axial Ratio (dB)	2.4	1.7	1.6
Phase Centre Offset PCO (cm)	0.2	0.2	0.2
Phase Centre Variation	0.8	0.8	0.8
Polarization	R.H.C.P.		
Impedance	50Ω		

Note. The patch antenna test with hybrid coupler XC1400P-03S

LNA and Filter Electrical Properties			
Frequency (MHz)	1561	1575.42	1602
VSWR (max.)	2.0:1	2.0:1	2.0:1
Gain@1.8V (Typ.)	31.3 dB	30.2 dB	29.8 dB
Gain@3.0V (Typ.)	31.1 dB	30.1 dB	30.0 dB
Gain@5.5V (Typ.)	33.5 dB	33.0 dB	33.1 dB
Noise@1.8V (Typ.)	3.1 dB	2.7 dB	3.0 dB
Noise@3.0V (Typ.)	3.1 dB	2.7 dB	3.0 dB
Noise@5.5V (Typ.)	3.3 dB	2.9 dB	3.2 dB
Power consumption@1.8V (Typ.)	5.0mA		
Power consumption@3.0V (Typ.)	5.1mA		
Power consumption@5.5V (Typ.)	5.2mA		
Total Specification (Through Antenna, SAW Filter and LNA)			
Frequency (MHz)	1561	1575.42	1602
Gain@3V (dB)	32.8dB	35.5dB	33.7dB
Output Impedance	50 Ω		

Mechanical	
Ceramic Dimension	25 x 25 x 4.0mm
Total Dimension (Including Shielding Case)	28x28 mm
Connector	IPEX MHFI (U.FL)
Cable	Coaxial Cable ϕ 1.13, length 60mm
Weight	13.5g
Environmental	
Operation Temperature	-40°C to 85°C
Storage Temperature	-40°C to 85°C
Humidity	Non-condensing 65°C 95% RH
RoHS Compliant	Yes
REACH Compliant	Yes

3. Antenna Characteristics

3.1 Return Loss

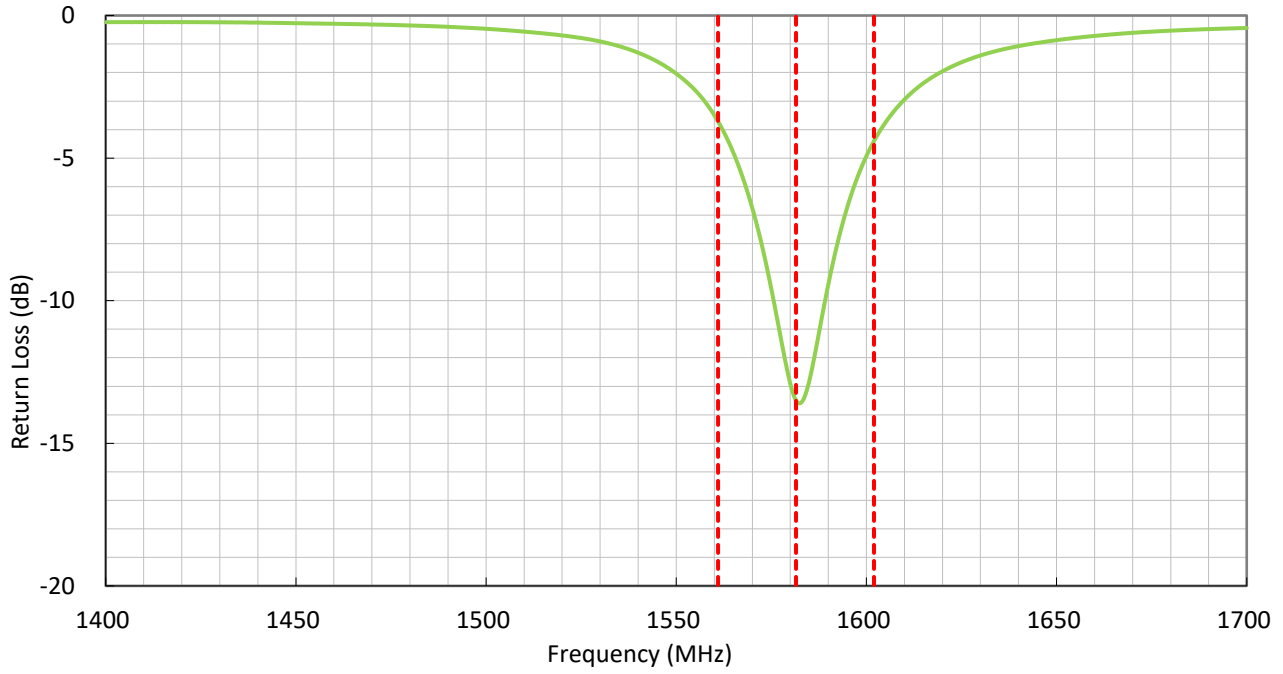

3.2 Efficiency

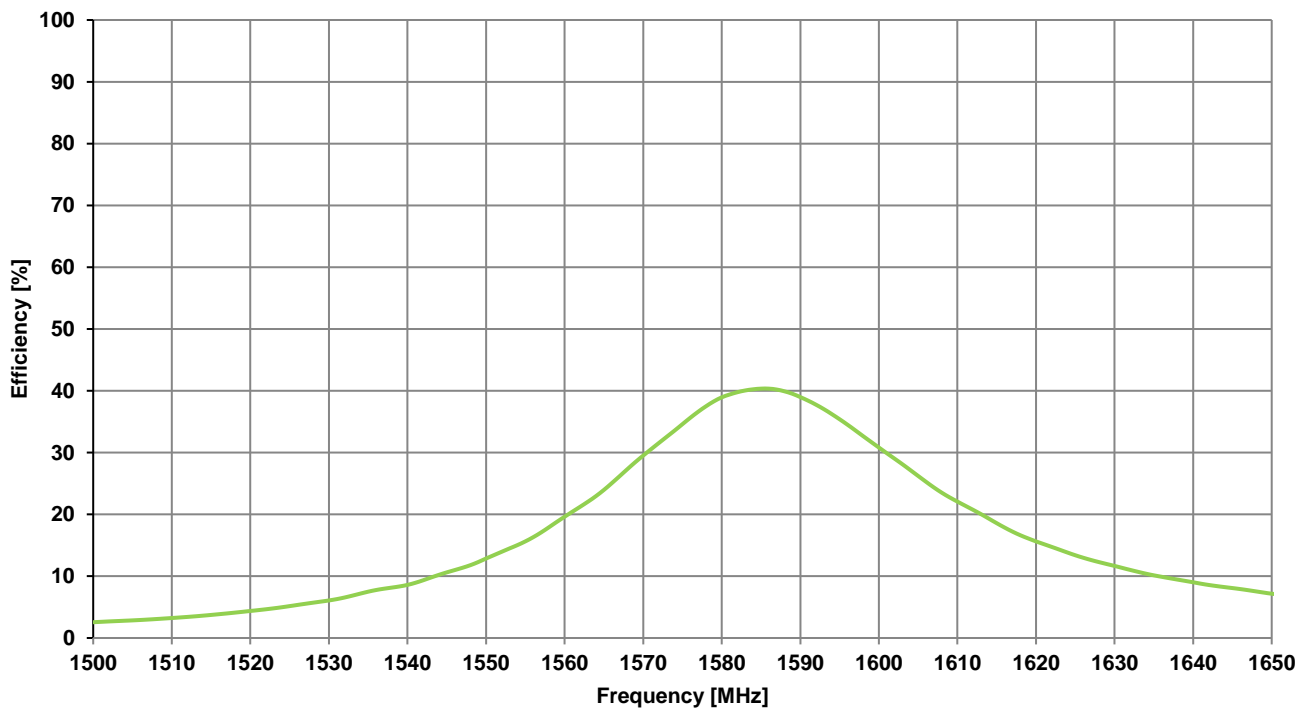

3.3 Average Gain

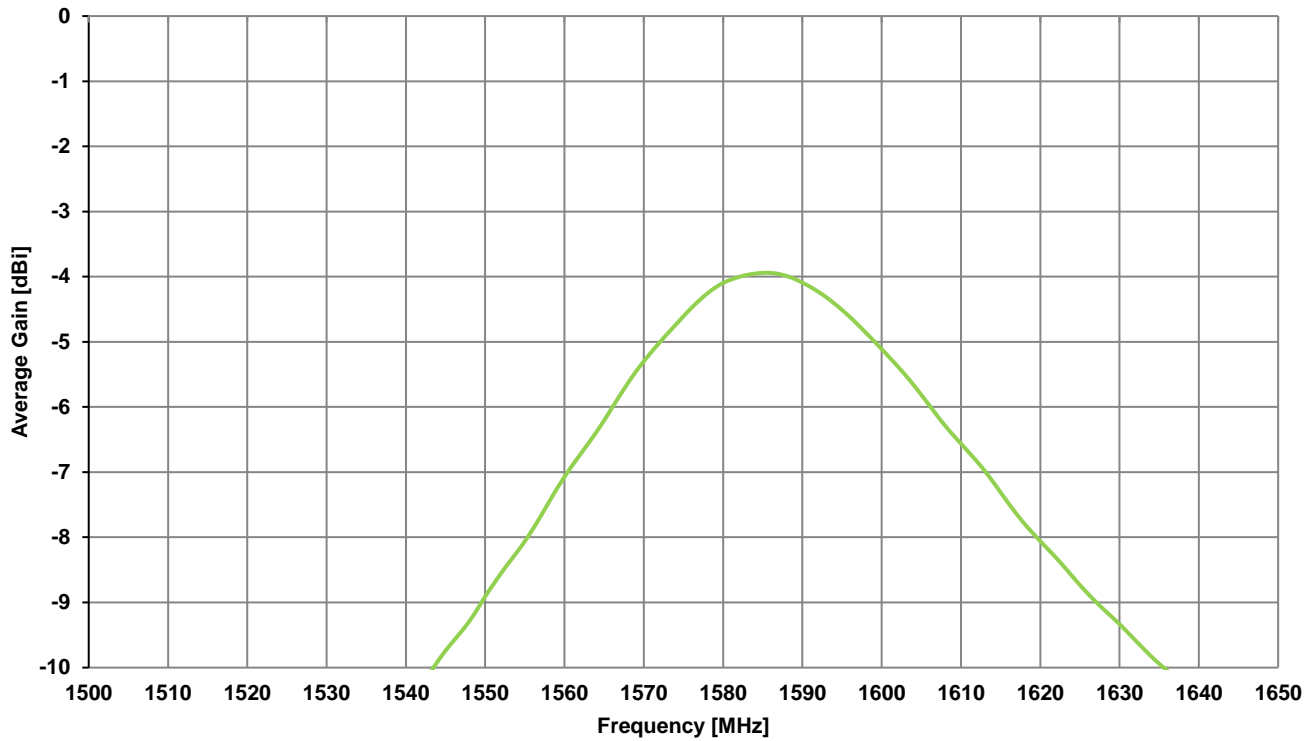

3.4 Peak Gain

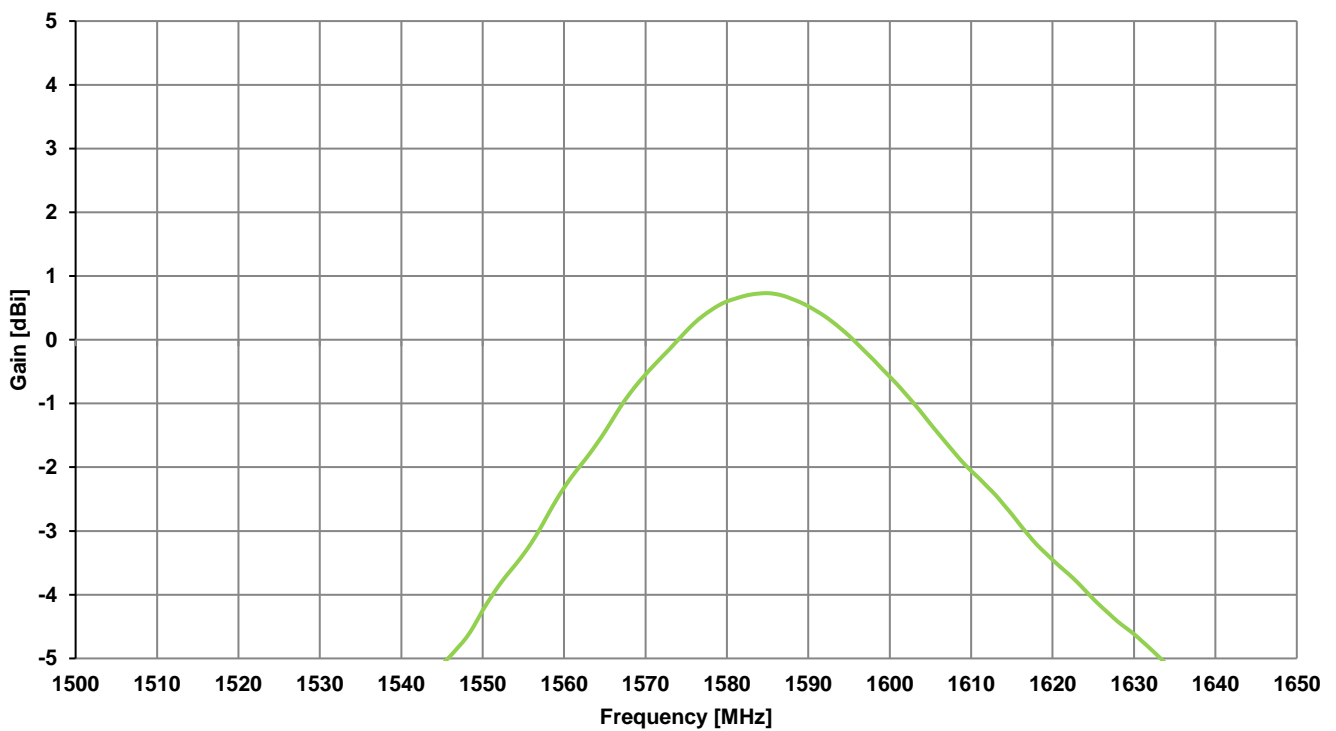

3.5 Axial Ratio vs Frequency

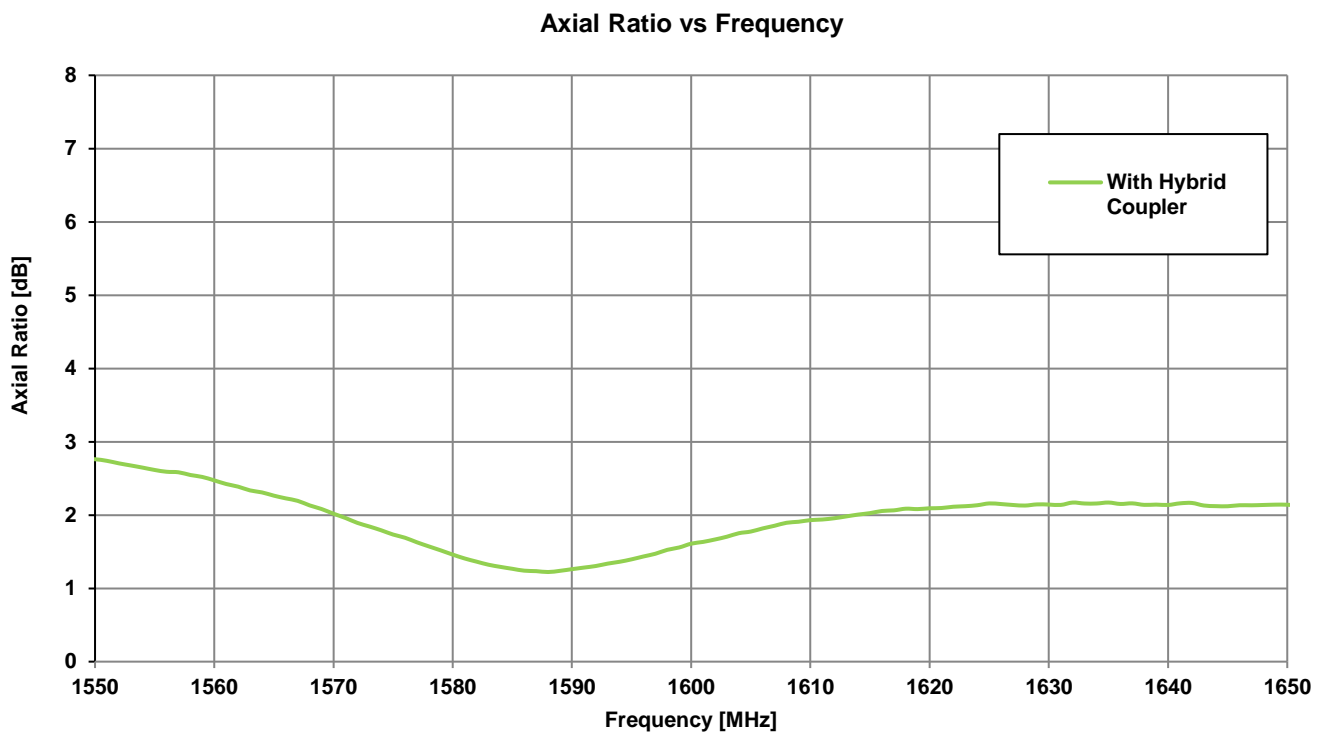

3.6 Axial Ratio vs Degrees

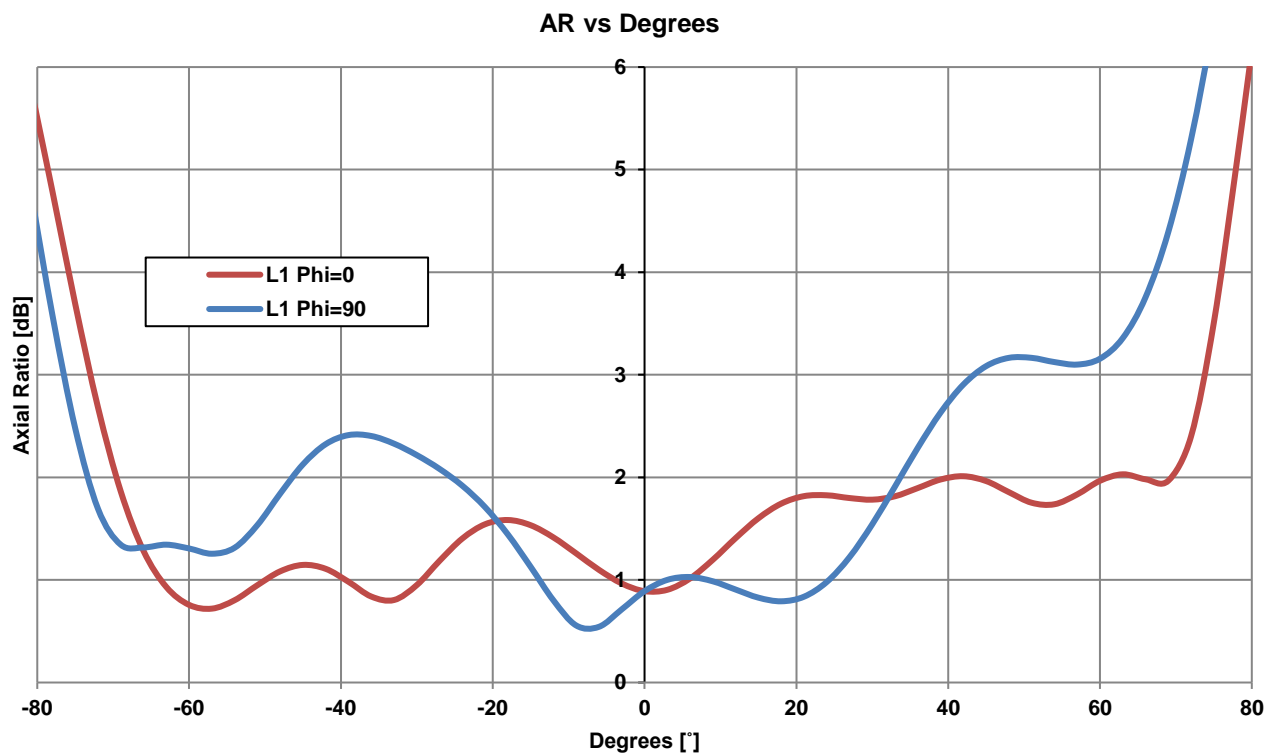

4. Radiation Patterns

4.1 Test Setup

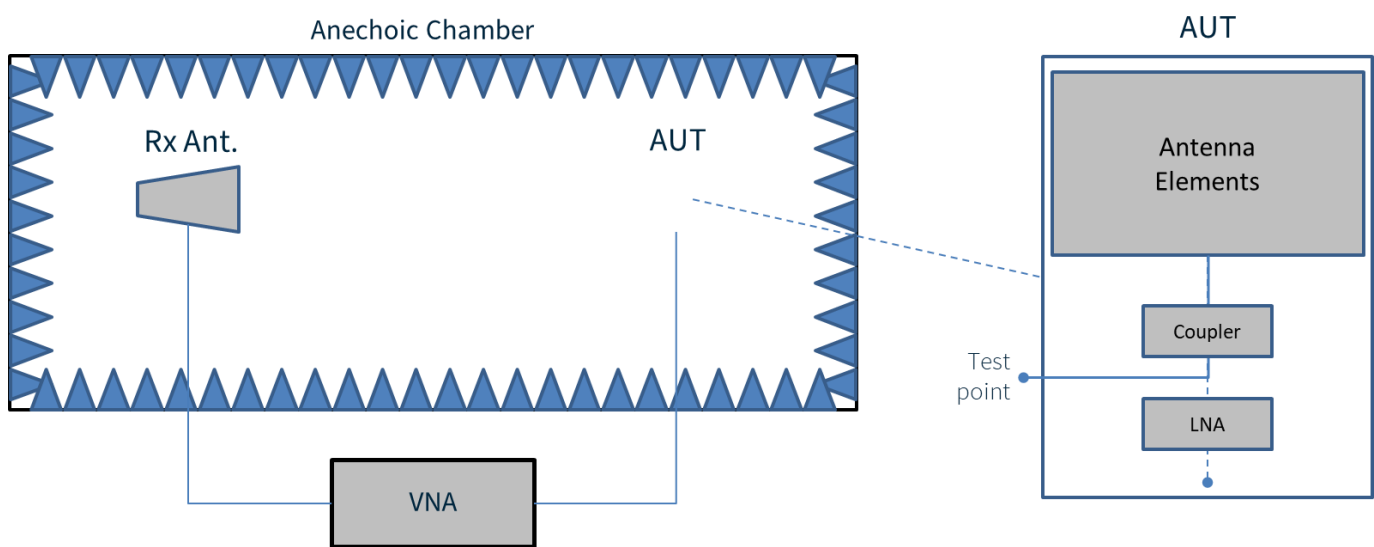

4.2 2D Radiation Patterns

XY Plane

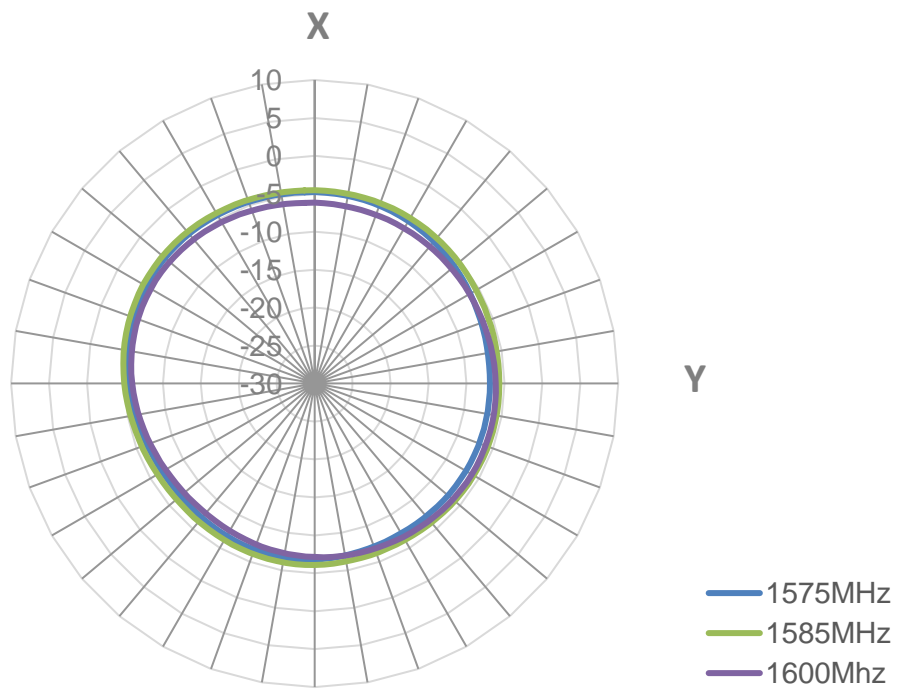

XZ Plane

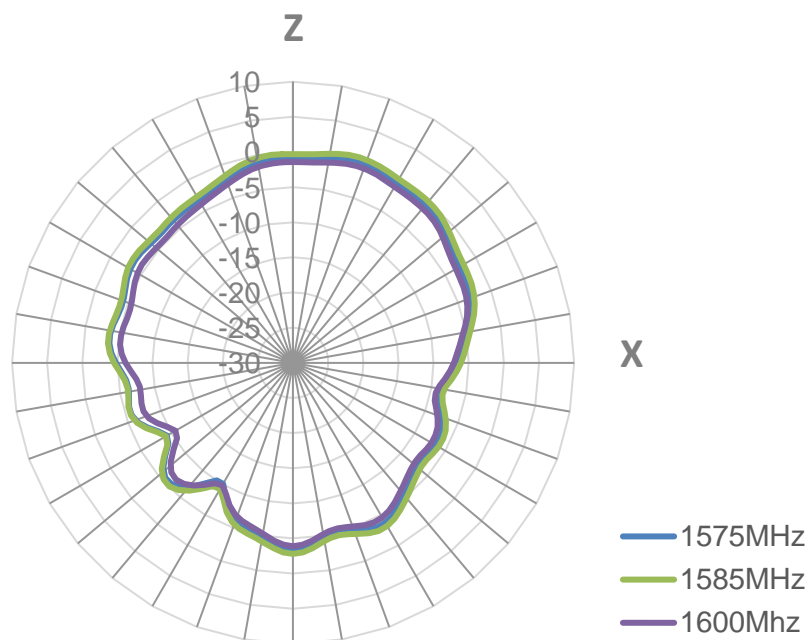

ZY Plane

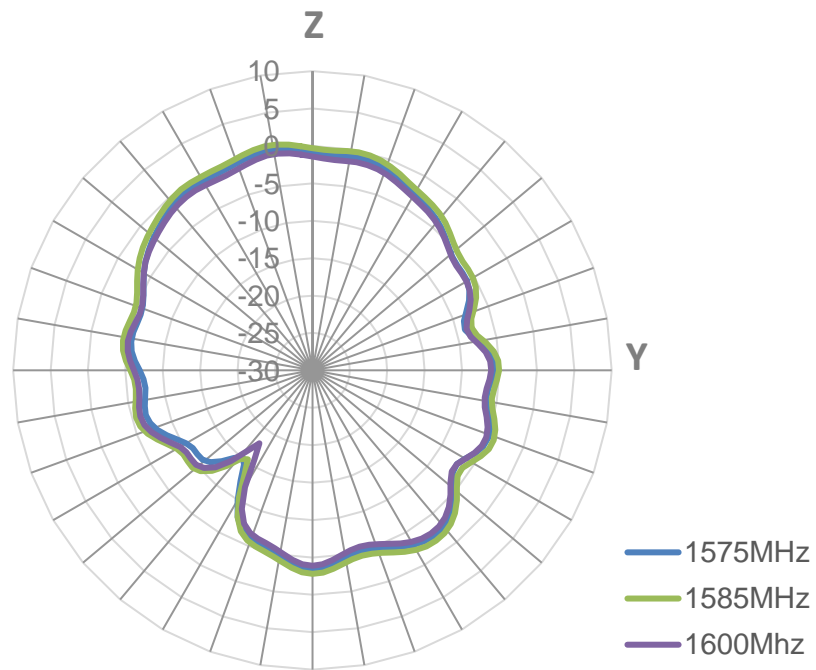

5. LNA Characteristics

5.1 Block Diagram (Active Antenna)

GPS + GLONASS + Beidou
Antenna
(Dual Pin Patch)

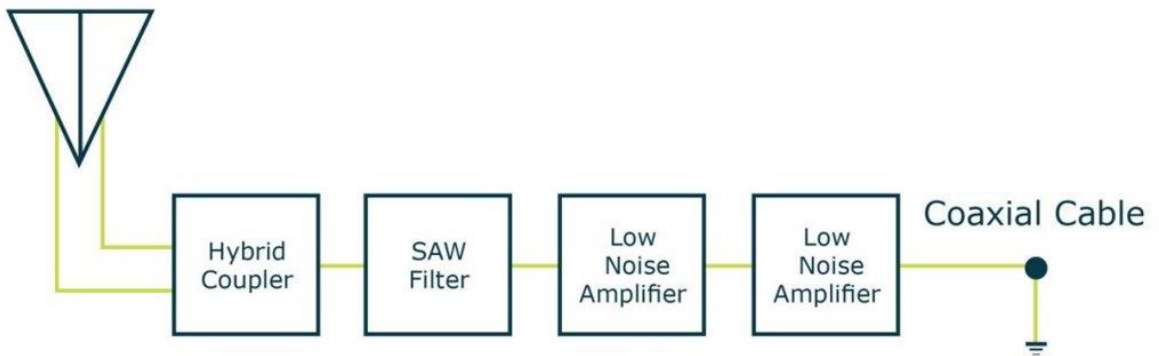

5.2 LNA Gain & Noise Figure (dB)

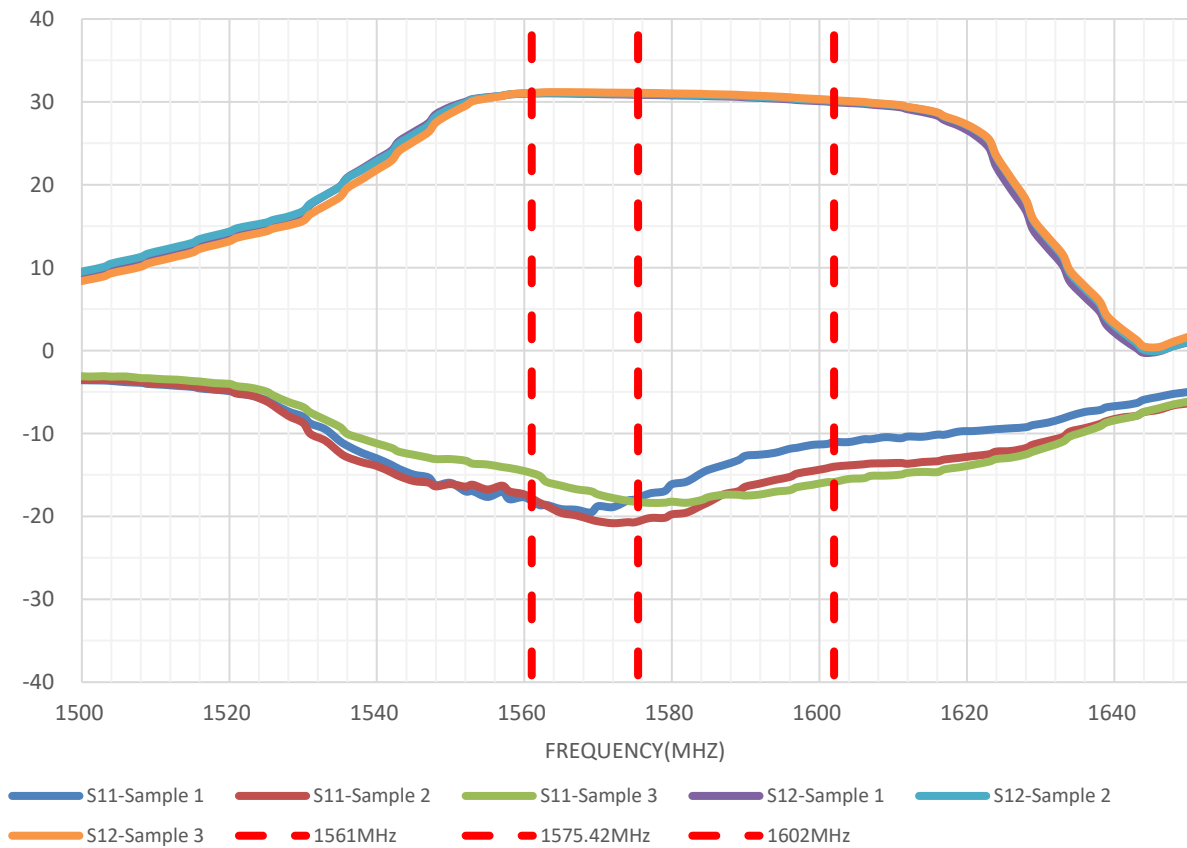

5.3 S12 Wide Band Plot

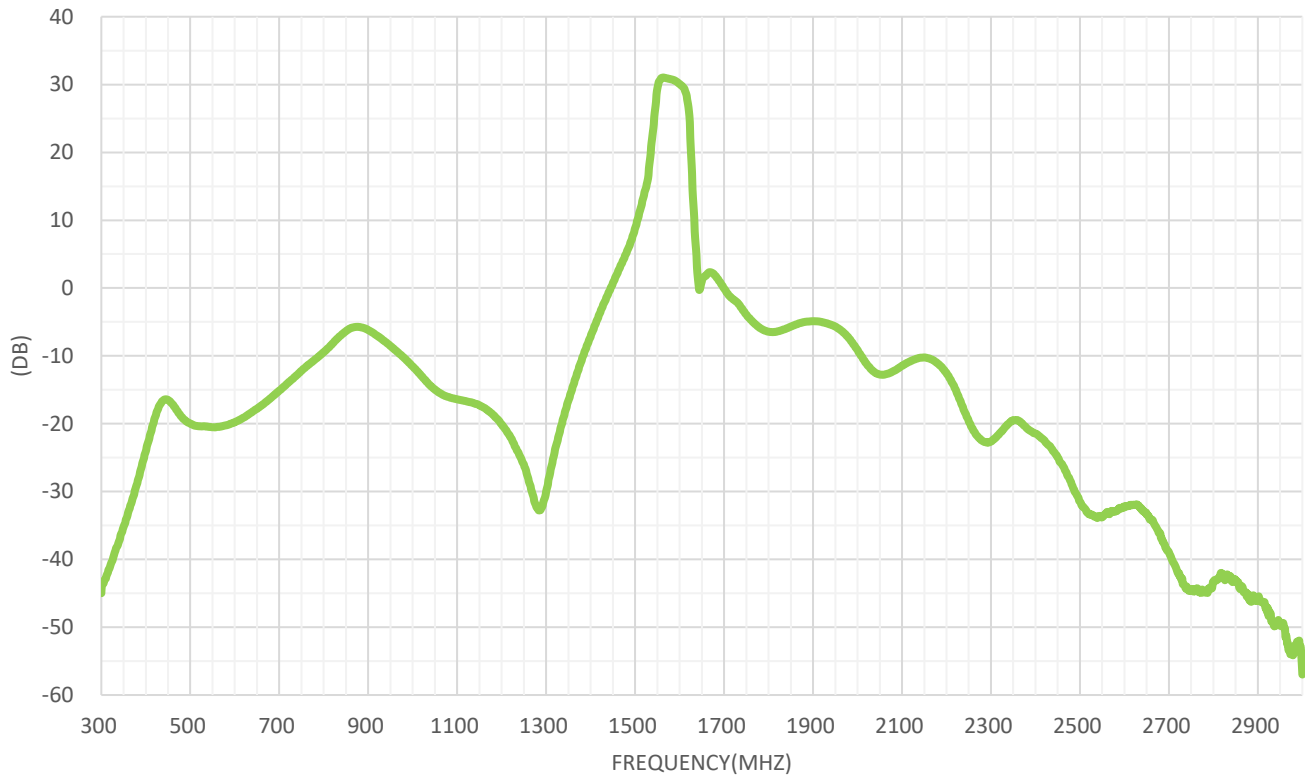

5.4 Noise Figure - LNA

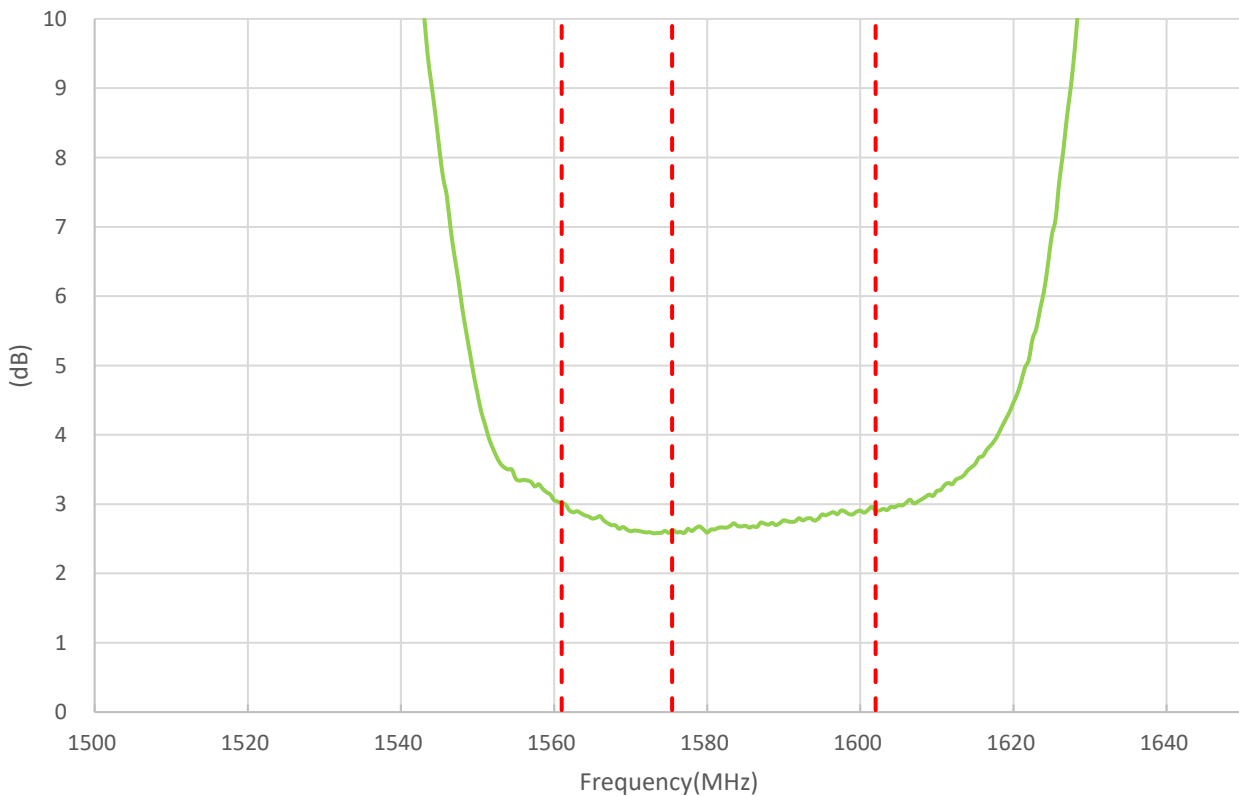

6. Mechanical Drawing (Units: mm)

ISO NO.: EDW-19-8-1521

STATE: Release

- NOTES:
1. Soldered area
 2. Soldermask area
 3. Silver Area
 4. Shielding case area
 5. All material must be RoHS compliant.
 6. The connector orientation has a fixed position to the antenna as per drawing.

REV.	DESCRIPTION	ENG.	APPROVED	DATE
001	Initial Design	Rachel Di	Aaron	2019/11/29
002	Change Patch Text	Mickey	Buluto	2020/03/06

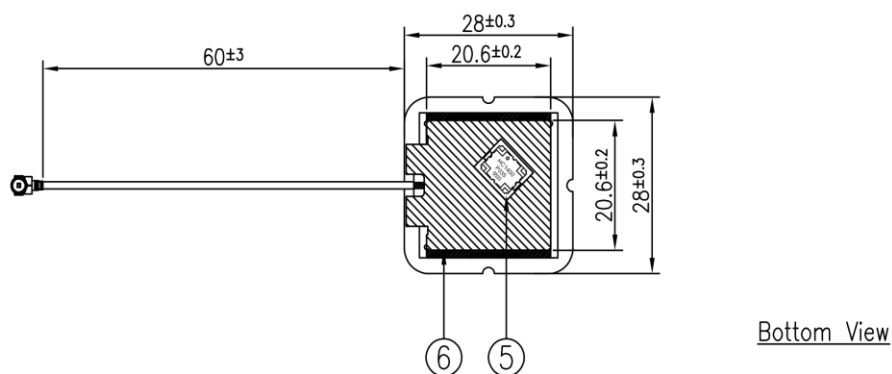
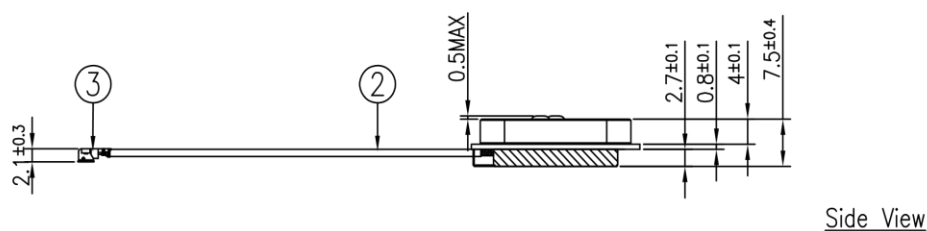
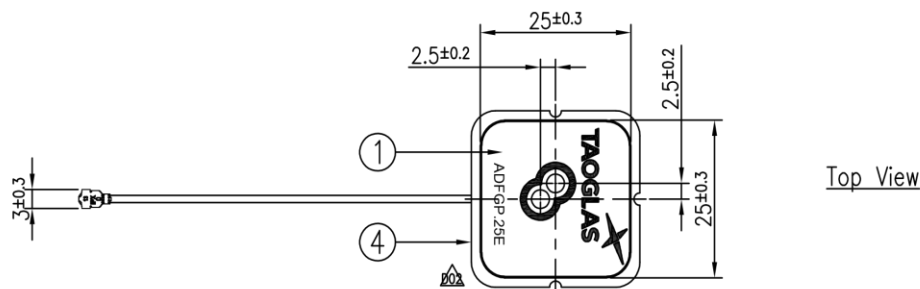

Name	P/N	Material	Finish	QTY
1 Patch Antenna	013A016000128D	Ceramic	Clear	1
2 1.13 Coaxial Cable	300215C020000A	FEP	Black	1
3 IPEX MHF1 (20308-112R-13)	204118G010000A	Brass	Au Plated	1
4 PCB	02110212200110	Composite GR	Green	1
5 Hybrid Coupler(HC-1400-P03)	001518K020000A	Composite	White	1
6 Shielding Case	001518K020000A	SPT	Sn plated	1

APPROVED BY: Buluto	<p>TW Design Centre This drawing and its inherent design concepts are property of Taoglas. Not to be copied or given to third parties without the written consent of Taoglas.</p>										
CHECK BY: Leo											
DRAWN BY: Mickey											
DATE: 2020/03/06	TITLE : GPS/GLONASS/BeiDou Dual Pin Active Antenna 60mm 1.13 IPEX MHF1(U.FL comp) - tuned for Free Space										
UNLESS OTHERWISE SPECIFIED TOLERANCES ON:	<table border="0"> <tr> <td>XL±0.5</td> <td></td> </tr> <tr> <td>X±0.3</td> <td></td> </tr> <tr> <td>X±0.2</td> <td></td> </tr> <tr> <td>X±0.1</td> <td></td> </tr> <tr> <td>X±0.05</td> <td></td> </tr> </table>	XL±0.5		X±0.3		X±0.2		X±0.1		X±0.05	
XL±0.5											
X±0.3											
X±0.2											
X±0.1											
X±0.05											
THIRD ANGLE PROJECTION	PART NO. : ADFGP.25E.07.0060A										
UNIT: mm	SCALE: 1:1										
PAGES: 1/1	REV. D02										

7. Packaging

30pcs ADFGP.25E.07.0060A per Tray
Weight: 615g

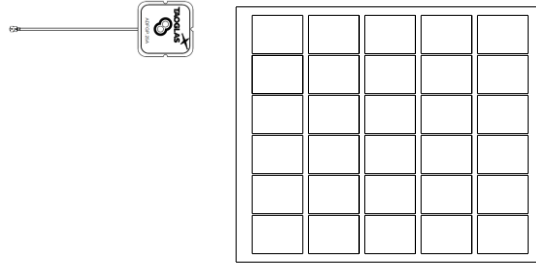

150pcs ADFGP.25E.07.0060A per PE
Bag Dimensions: 420*560 mm
Weight: 3.075Kg

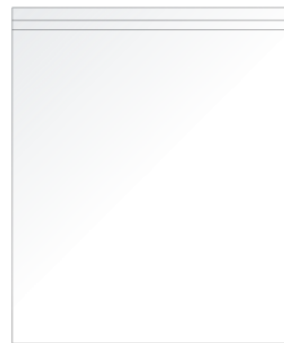

450pcs ADFGP.25E.07.0060A per carton
Dimensions - 390*320*290mm
Weight: 9.4Kg

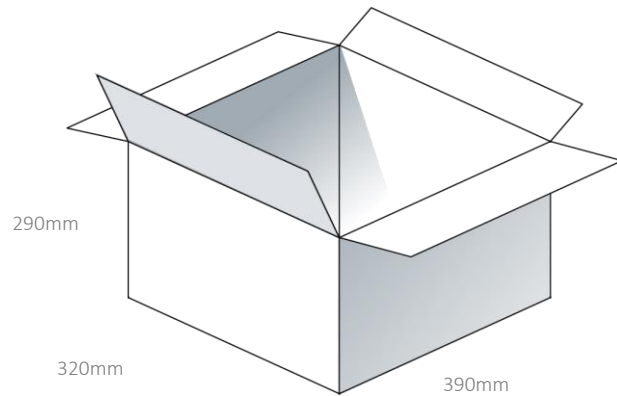

Changelog for the datasheet

SPE-20-8-069 – ADFGP.25A.07.0060A

Revision: A	
Date:	2020-06-12
Changes:	Initial Release
Changes Made by:	Jack Conroy

Previous Revisions



TAOGLAS®

www.taoglas.com

