



FEATURES

- ♦ High efficiency : 87 @ 110Vin full load
- ♦ Size:61.0mm*57.9mm*12.7mm(2.4" *2.28" *0.5")
- ♦ Industry standard pin out and footprint
- ♦ Fixed frequency operation
- ♦ Input UVP/ OVP
- ♦ Hiccup output over current protection (OCP)
- ♦ Hiccup output over voltage protection (OVP)
- ♦ Output current limited protection(OCL)
- ♦ Auto recovery OTP
- ♦ Positive enable (negative enable optional)
- ♦ Monotonic startup into normal
- ♦ 3000V isolation and reinforce insulation
- ♦ No minimum load required
- ♦ ISO 9001, TL 9000, ISO 14001, QS9000, OHSAS18001 certified manufacturing facility
- ♦ EN61373, EN50155
- ♦ EN60950-1

Delphi Series HA1SV24, half Brick Family DC/DC Power Modules: 53~154V in, 24V/2.1A out, 50W

The Delphi Module HA1SV24002, half brick, 53~154V input, single output, isolated DC/DC converter is the latest offering from a world leader in power system and technology and manufacturing — Delta Electronics, Inc. This product provides up to 50 watts power in an industry standard footprint and pin out. With creative design technology and optimization of component placement, these converters possess outstanding electrical and thermal performances, as well as extremely high reliability under highly stressful operating conditions.

APPLICATIONS

- ♦ Railway /Transportation system

TECHNICAL SPECIFICATIONS

PARAMETER	NOTES and CONDITIONS	HA1SV24002			
		Min.	Typ.	Max.	Units
1. ABSOLUTE MAXIMUM RATINGS					
1.1 Input Voltage	EN50155	53	110	154	Vdc
1.2 Input surge withstand	<100ms			250	Vdc
1.3 Operating Ambient Temperature		-40		100	°C
1.4 Storage Temperature		-55		125	°C
1.5 Input/Output Isolation Voltage	reinforce			3000	Vrms
2. INPUT CHARACTERISTICS					
2.1 Operating Input Voltage		53	110	154	Vdc
2.2 Input Under-Voltage Lockout					
2.2.1 Turn-On Voltage Threshold		49	51	53	Vdc
2.2.2 Turn-Off Voltage Threshold		46	48	50	Vdc
2.3 Input Over-Voltage Lockout					
2.3.1 Turn-On Voltage Threshold		154	158	162	Vdc
2.3.2 Turn-Off Voltage Threshold		158	162	166	Vdc
2.4 Maximum Input Current	Full Load, 53Vin		1.1	1.2	A
2.5 No-Load Input Current	Vin=110V, Io=0A		18.3	30	mA
2.6 Off Converter Input Current	Vin=110V		10	30	mA
2.7 Input Reflected-Ripple Current (pk-pk)	Vin=110V, Io=full load, Cin=150uF/400V		35		mA
3. OUTPUT CHARACTERISTICS					
3.1 Output Voltage Set Point	Vin=110V, Io=0, Tc=25°C	23.8	24	24.2	Vdc
3.1.1 Load regulation	Vin=110V, Io=Io min to Io max		±0.05	±0.2	%
3.1.2 Line regulation	Vin=53V to 154V, Io=full load		±0.01	±0.2	%
3.1.3 Temperature regulation	Vin=110V, Tc= min to max case temperature		±0.004	±0.007	%/°C
3.2 Output Voltage Ripple and Noise	5Hz to 20MHz bandwidth				
3.2.1 Peak-to-Peak	Full Load,		70	100	mV
3.2.2 rms	Full Load,		23	35	mV
3.3 Operating Output Current Range		0		2.1	A
3.4 Output DC Current-Limit Inception		2.4	2.7	3.0	A
4. DYNAMIC CHARACTERISTICS					
4.1 Output Voltage Current Transient	110V, 0.1A/μs				
4.1.1 Positive Step Change in Output Current	50% Io,max to 75%		600	1200	mV
4.1.2 Negative Step Change in Output Current	75% Io,max to 50%		700	1200	mV
4.2 Turn-On Transient					
4.2.1 Start-Up Time, From On/Off Control			50	100	ms
4.2.2 Start-Up Time, From Input			48	80	ms
4.2.3 Rise time(Vout from 10% to 90%)			25	50	ms
4.3 Maximum output capacitor	Resistance load		300		μF
5. EFFICIENCY					
5.1 100% Load	Vin=110V	85.5	87	88.5	%
5.2 60% Load	Vin=110V	82.5	84	85.5	%
6. ISOLATION CHARACTERISTICS					
6.1 Input to Output				3000	Vac
6.2 Input to base				1500	Vac
6.3 Output to base				1500	Vac
6.4 Isolation Resistance			100		MΩ
7. FEATURE CHARACTERISTICS					
7.1 Switching Frequency			300		kHz
7.2 ON/OFF Control					
7.2.1 Logic High		3		5	V
7.2.2 Logic Low		0		1	V
7.3 Output Voltage Trim Range		-10		10	%
7.4 Output Over-Voltage Protection	Over full temp range; % of nominal Vout	110	120	130	%
8. GENERAL SPECIFICATIONS					
8.1 Weight	With heat spreader		80		grams
8.2 Over-Temperature Shutdown (NTC resistor)	Refer to Figure 18 for NTC resistor location		118		°C
8.3.MTBF			1,302,169		hours

(TA=25°C, Natural convection, Vin=110Vdc, nominal Vout unless otherwise noted;

ELECTRICAL CHARACTERISTICS CURVES

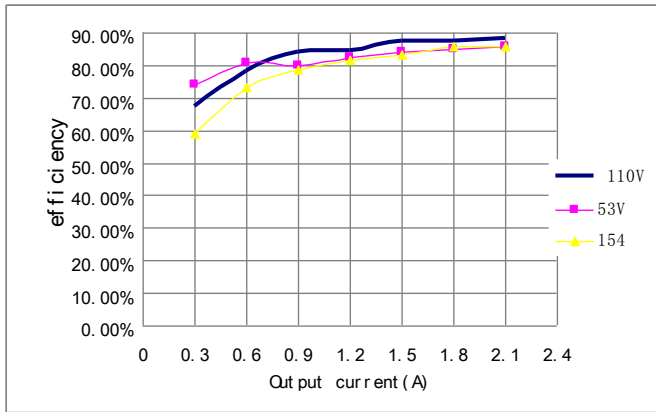

Figure 1: Efficiency vs. load current for 53, 110 and 154 input voltage at 25°C.

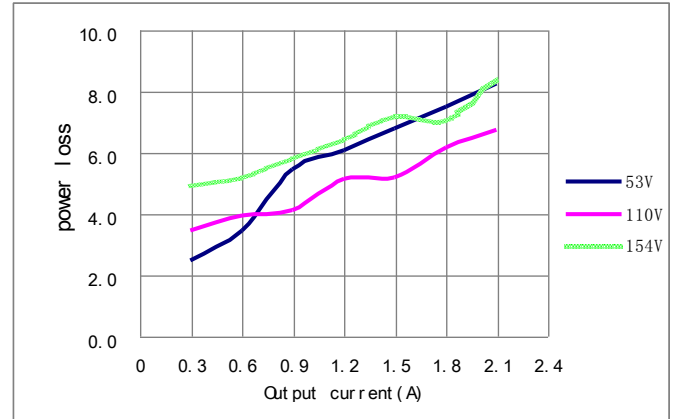

Figure 2: Power dissipation vs. load current for 53, 110 and 154 input voltage at 25°C.

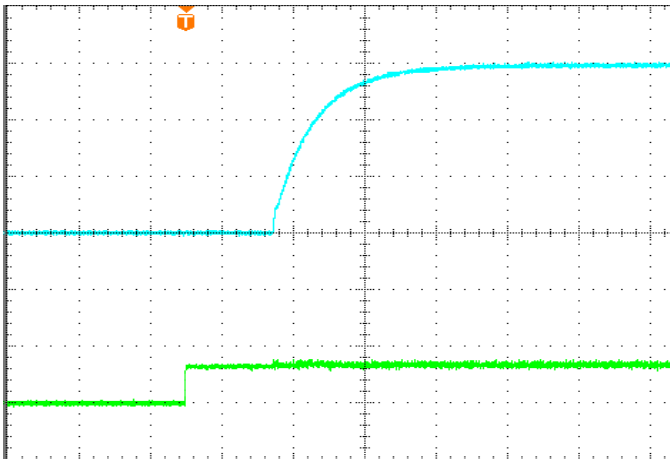

Figure 3: Turn-on transient at zero load current (20ms/div). Top Trace: Vout; 5V/div; Bottom Trace: ON/OFF input: 5V/div.

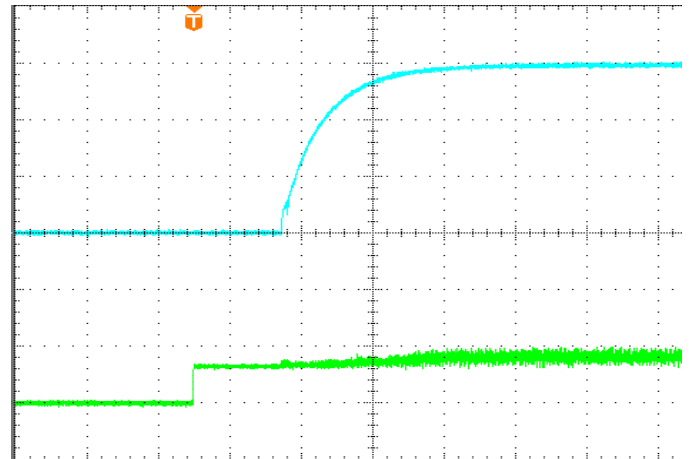

Figure 4: Turn-on transient at full load current (20ms/div). Top Trace: Vout; 5V/div; Bottom Trace: ON/OFF input: 5V/div.

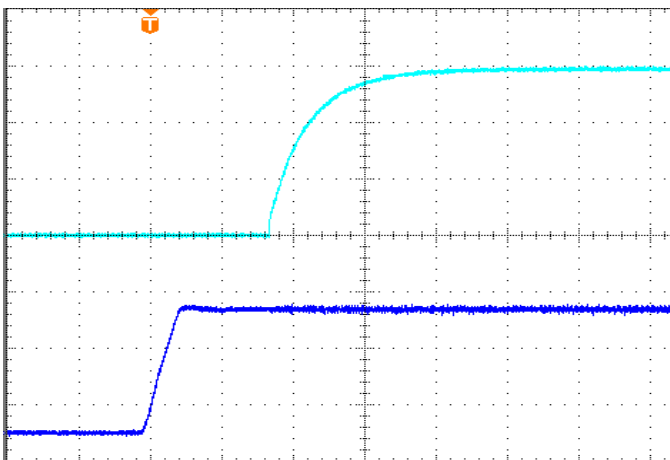

Figure 5: Turn-on transient at zero load current (20ms/div). Top Trace: Vout; 8V/div; Bottom Trace: input voltage: 50V/div.

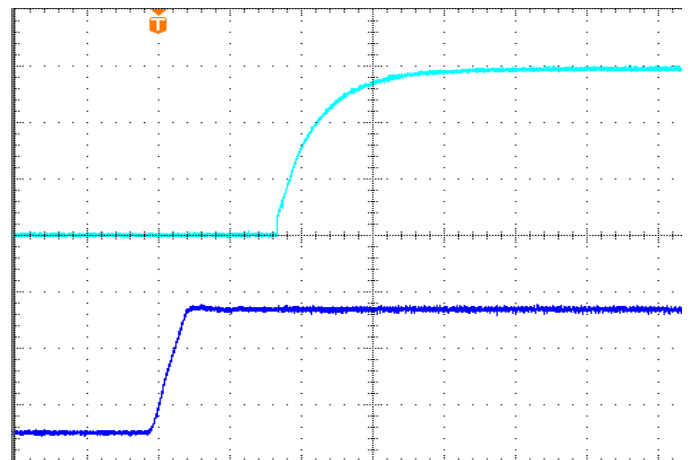

Figure 6: Turn-on transient at full load current (20ms/div). Top Trace: Vout; 8V/div; Bottom Trace: input voltage: 50V/div.

ELECTRICAL CHARACTERISTICS CURVES

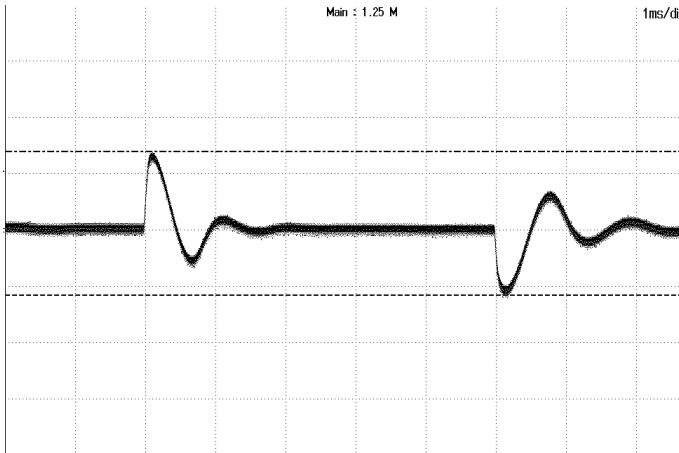

Figure 7: Output voltage response to step-change in load current (50%-75%-50% of full load; $di/dt = 0.1A/\mu s$).
Bottom Trace: V_{out} ; 500mV/div; Time: 1ms/div

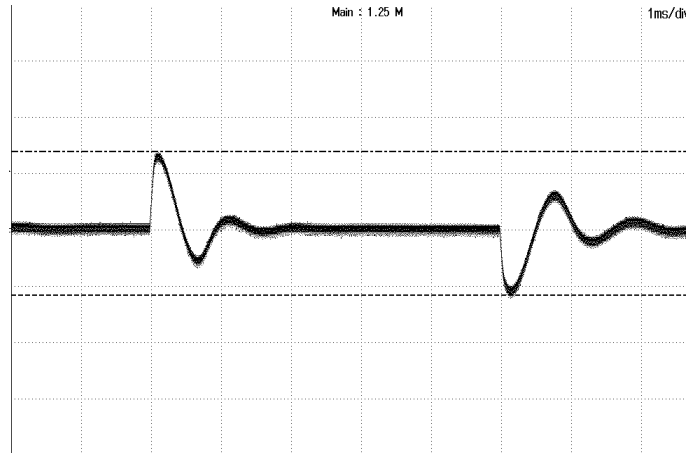

Figure 8: Output voltage response to step-change in load current (50%-75%-50% of full load; $di/dt = 2.5A/\mu s$).
Bottom Trace: V_{out} ; 500mV/div; Time: 1ms/div

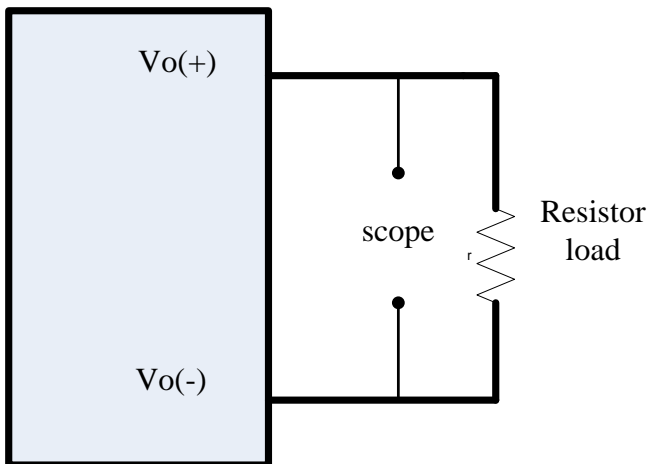

Figure 9: Output voltage noise and ripple measurement test setu

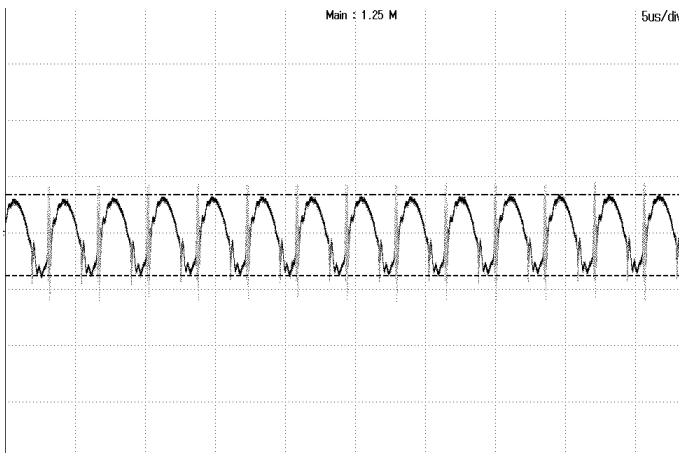

Figure 10: Output voltage ripple at nominal input voltage and max load current (50 mV/div, 5us/div) Bandwidth: 20 MHz.

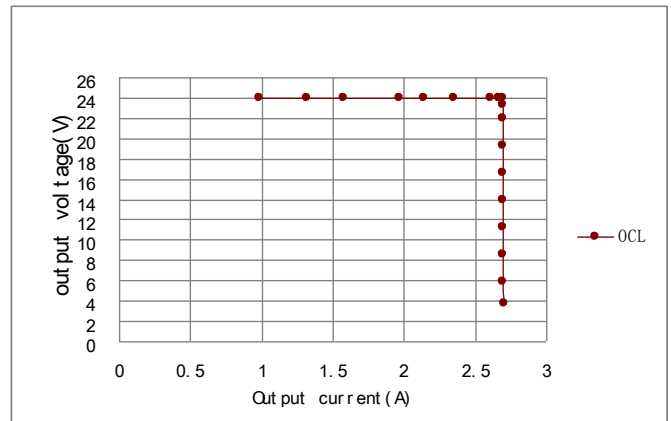

Figure 11: Output voltage vs. load current showing typical current limit curves and converter shutdown points.

DESIGN CONSIDERATIONS

Input Source Impedance

The impedance of the input source connecting to the DC/DC power modules will interact with the modules and affect the stability. A low ac-impedance input source is recommended. If the source inductance is more than a few μH , we advise 150 μF electrolytic capacitor (ESR < 0.7 Ω at 100 kHz) mounted close to the input of the module to improve the stability.

Layout and EMC Considerations

Delta's DC/DC power modules are designed to operate in a wide variety of systems and applications. For design assistance with EMC compliance and related PWB layout issues, please contact Delta's technical support team. Below is the reference design for an input filter tested with HA1SV24002 to meet class A in CISPR 22.

Schematic and Components List

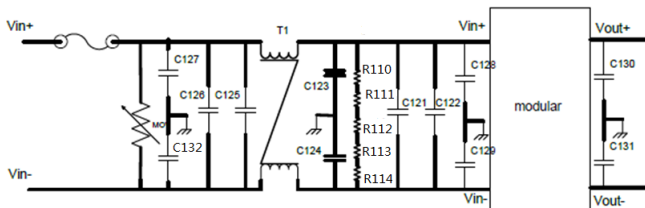

Figure 12 EMI test schematic

C121=120 μF /400V

C123,C124,C127,C132 =220pF/275VAC

C128,C129,C130,C131=2200pF/300VAC

C122,C125,C126=0.47 μF /250V

T1=3.4mH, common choke

R110,R111,R112,R113,R114=300k Ω /1206

Test Result:

At T = +25°C , Vin = 110V and full load
black line is Qpeak value;

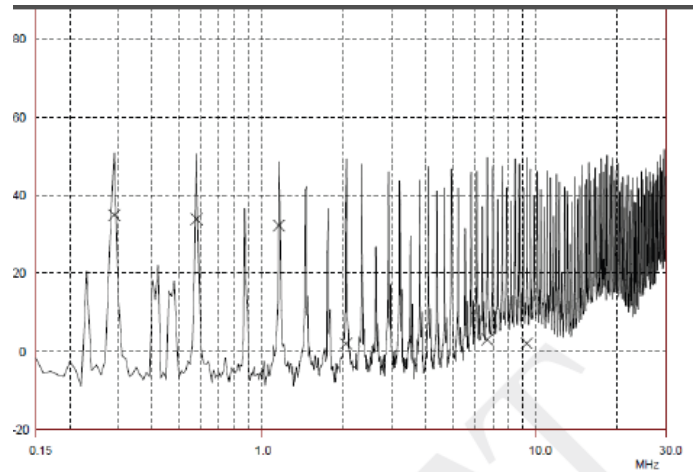

Figure 13 EMI test positive line

Safety Considerations

The power module must be installed in compliance with the spacing and separation requirements of the end-user's safety agency standard, i.e., UL60950-1, CSA C22.2 NO. 60950-1 2nd and IEC 60950-1 2nd : 2005 and EN 60950-1 2nd: 2006+A11+A1: 2010, if the system in which the power module is to be used must meet safety agency requirements.

Basic insulation based on 110 Vdc input is provided between the input and output of the module for the purpose of applying insulation requirements when the input to this DC-to-DC converter is identified as TNV-2 or SELV. An additional evaluation is needed if the source is other than TNV-2 or SELV.

When the input source is SELV circuit, the power module meets SELV (safety extra-low voltage) requirements. If the input source is a hazardous voltage which is greater than 60 Vdc and less than or equal to 110 Vdc, for the module's output to meet SELV requirements, all of the following must be met:

- The input source must be insulated from the ac mains by reinforced or double insulation.
- The input terminals of the module are not operator accessible.
- A SELV reliability test is conducted on the system where the module is used, in combination with the module, to ensure that under a single fault, hazardous voltage does not appear at the module's output.

When installed into a Class II equipment (without grounding), spacing consideration should be given to the end-use installation, as the spacing between the module and mounting surface have not been evaluated.

The power module has extra-low voltage (ELV) outputs when all inputs are ELV.

This power module is not internally fused. To achieve optimum safety and system protection, an input line fuse is highly recommended. The safety agencies require a normal-blow fuse with 10A maximum rating to be installed in the ungrounded lead. A lower rated fuse can be used based on the maximum inrush transient energy and maximum input current.

Soldering and Cleaning Considerations

Post solder cleaning is usually the final board assembly process before the board or system undergoes electrical testing. Inadequate cleaning and/or drying may lower the reliability of a power module and severely affect the finished circuit board assembly test. Adequate cleaning and/or drying is especially important for un-encapsulated and/or open frame type power modules. For assistance on appropriate soldering and cleaning procedures, please contact Delta's technical support team.

FEATURES DESCRIPTIONS

Over-Current Protection

The modules include an internal output over-current protection circuit, which will endure current limiting for an unlimited duration during output overload. If the output current exceeds the OCP set point, the modules will shut down, and will try to restart after shutdown(hiccup mode). If the overload condition still exists, the module will shut down again. This restart trial will continue until the overload condition is corrected.

Over-Voltage Protection

The modules include an internal output over-voltage protection circuit, which monitors the voltage on the output terminals. If this voltage exceeds the over-voltage set point, the protection circuit will constrain the max duty cycle to limit the output voltage, if the output voltage continuously increases the modules will shut down, and then restart after a hiccup-time (hiccup mode).

Over-Temperature Protection

The over-temperature protection consists of circuitry that provides protection from thermal damage. If the module will shut down. The module will restart after the temperature is within specification.

Remote On/Off

The remote on/off feature on the module can be either negative or positive logic. Negative logic turns the module on during a logic low and off during a logic high. Positive logic turns the modules on during a logic high and off during a logic low.

Remote on/off can be controlled by an external switch between the on/off terminal and the Vi (-) terminal. The switch can be an open collector or open drain. For negative logic if the remote on/off feature is not used, please short the on/off pin to Vi (-). For positive logic if the remote on/off feature is not used, please leave the on/off pin to floating.

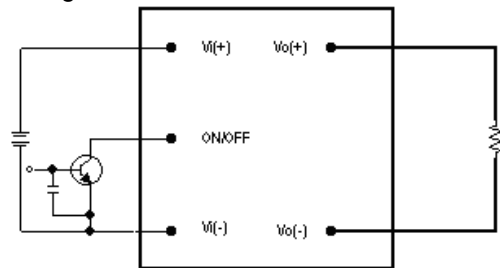

Figure 14: Remote on/off implementation

Output Voltage Adjustment (TRIM)

To increase or decrease the output voltage set point, connect an external resistor between the TRIM pin and SENSE(+) pin or SENSE(-) pin. The TRIM pin should be left open if this feature is not used.

For trim down, the external resistor value required to obtain a percentage of output voltage change $\Delta\%$ is defined as:

$$R_{trim-down} = \left[\frac{10 * V_{nom} * (1 - \Delta)}{V_{nom} - V_{nom} * (1 - \Delta)} \right] (K\Omega)$$

Ex. When Trim-down -10% ($24V \times 0.9 = 21.6V$)

$$R_{trim-down} = \left[\frac{10 * 24 * 0.9}{24 - 24 * 0.9} \right] (K\Omega) = 90(K\Omega)$$

For trim up, the external resistor value required to obtain a percentage output voltage change $\Delta\%$ is defined as:

$$R_{trim-up} = \left[\frac{[V_{nom}(1 + \Delta) - 2.5] * 10}{\Delta * 2.5} - 10 \right] K\Omega$$

Ex. When Trim-up +10% ($24V \times 1.1 = 26.2V$)

$$R_{trim-up} = \left[\frac{[24(1 + 0.1) - 2.5] * 10}{\Delta * 2.5} - 10 \right] = 946(K\Omega)$$

The output voltage can be increased by both the remote sense and the trim, however the maximum increase is the larger of either the remote sense or the trim, not the sum of both.

The output voltage can be increased by both the remote sense and the trim, however the maximum increase is the larger of either the remote sense or the trim, not the sum of both.

When using remote sense and trim, the output voltage of the module is usually increased, which increases the power output of the module with the same output current.

Care should be taken to ensure that the maximum output power of the module remains at or below the maximum rated power.

Pin function

The pin was define as follow in figure 20 ,we will explain the pin function:

+IN, -IN . DC voltage inputs.

Gate IN. The Gate IN pin on a driver module may be used as a logic enable/disable input. When Gate IN is pull low (<1V, referenced to $-V_{in}$), the module is turned off . when Gate IN is floating (open collector) ,the module is turned on .The open circuit voltage of Gate in PIN is less than 5V.

Gate OUT. The pulsed signal at the Gate OUT pin of a regulating driver module is used to synchronously drive the surge circuit in order to meet the IRA12 surge needed. If you don't used this function, please floating it.

+OUT, -OUT. DC voltage outputs.

T (TRIM). Provides fixed or variable adjustment of the module output.

Trimming down. Allows output voltage of the module to be trimmed down, with a decrease in efficiency .ripple as a percent of output voltage goes up and input range widens since input voltage dropout(loss of regulation) moves down

Trimming up. Reverses the above effects.

-Sense, +Sense. Provides for locating the point of optimal voltage regulation external to the converter.

THERMAL CONSIDERATIONS

Thermal management is an important part of the system design. To ensure proper, reliable operation, sufficient cooling of the power module is needed over the entire temperature range of the module. Convection cooling is usually the dominant mode of heat transfer.

Hence, the choice of equipment to characterize the thermal performance of the power module is a wind tunnel.

Thermal Testing Setup

Delta's DC/DC power modules are characterized in heated vertical wind tunnels that simulate the thermal environments encountered in most electronics equipment. This type of equipment commonly uses vertically mounted circuit cards in cabinet racks in which the power modules are mounted.

The following figure shows the wind tunnel characterization setup. The power module is mounted on a test PWB and is vertically positioned within the wind tunnel. The space between the neighboring PWB and the top of the power module is constantly kept at 6.35mm (0.25").

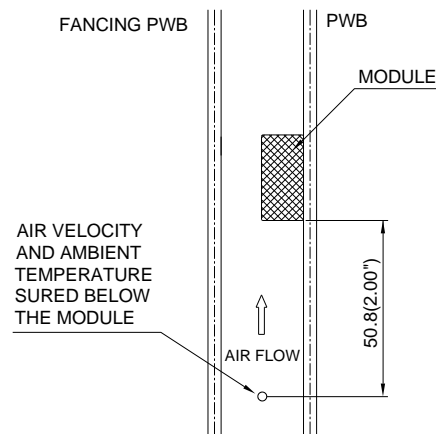

Note: Wind Tunnel Test Setup Figure Dimensions are in millimeters and (Inches)

Figure 15: Wind tunnel test setup

Thermal Derating

Heat can be removed by increasing airflow over the module. To enhance system reliability, the power module should always be operated below the maximum operating temperature. If the temperature exceeds the maximum module temperature, reliability of the unit may be affected.

THERMAL CURVES

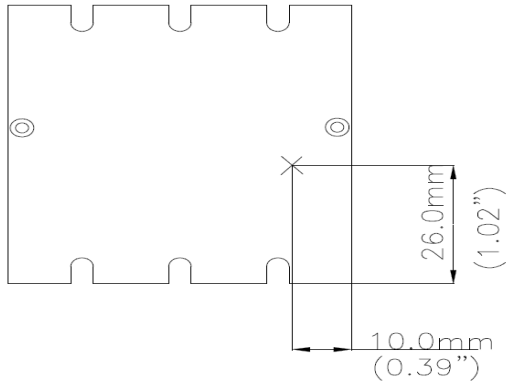

Figure 16: * temperature measured point

THERMAL CURVES

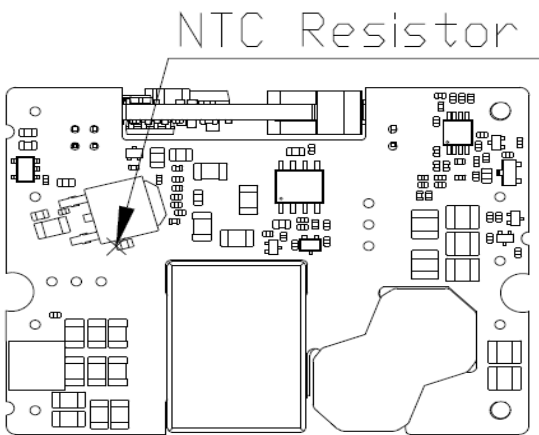

Figure 18: NTC resistor location

THERMAL CURVES

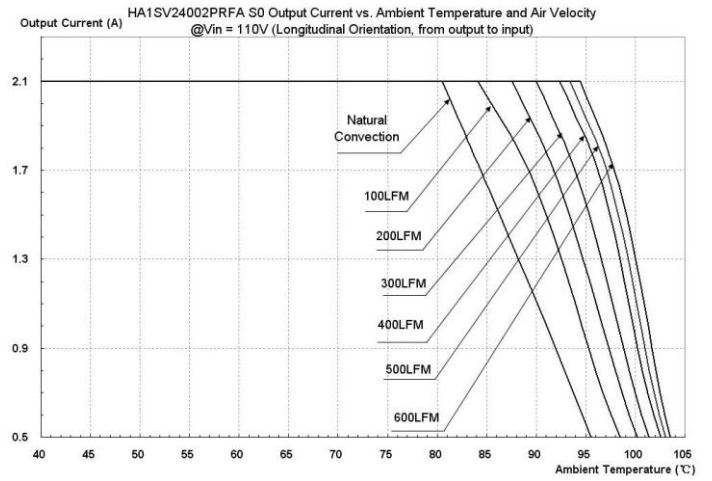

Figure 17: Output current vs. ambient temperature and air velocity @Vin=110V(Either Orientation, airflow from output to input, with heat spreader)

LEAD FREE (SAC) PROCESS RECOMMEND TEMP. PROFILE

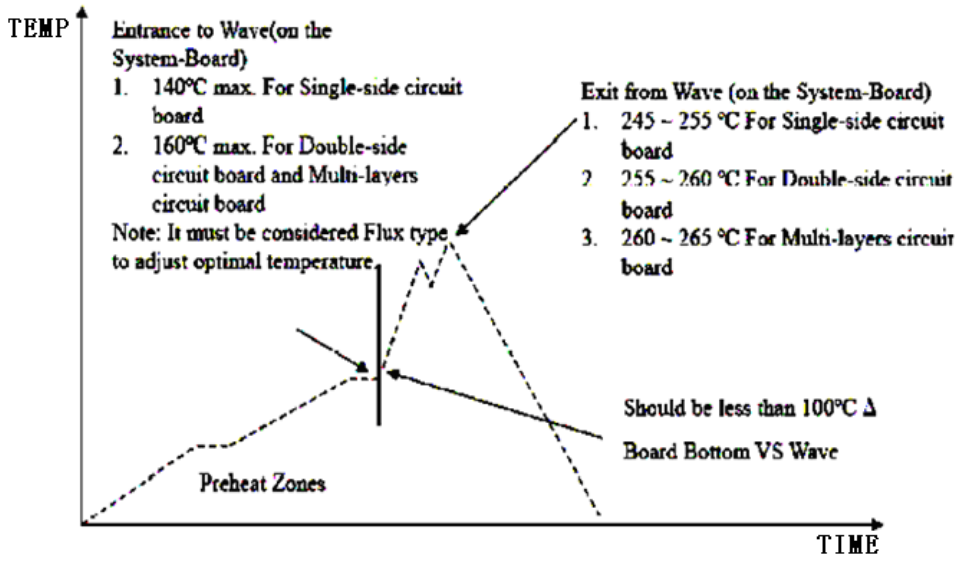
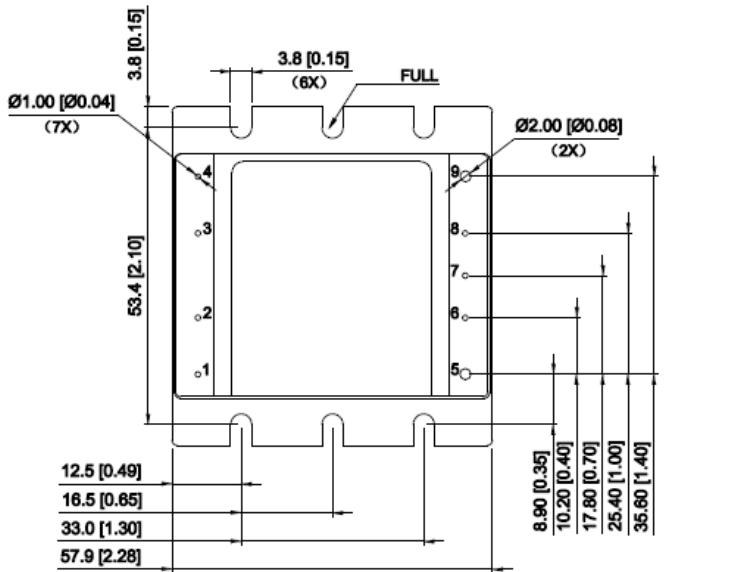

Figure 19 recommended temperature profile for lead-free wave soldering

MECHANICAL DRAWING (BASEPLATE)



PIN #	Function
1	+In
2	Gate In
3	Gate out
4	-In
5	+Out
6	+Sense
7	Trim
8	-Sense
9	-Out

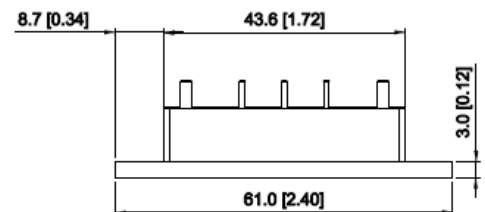
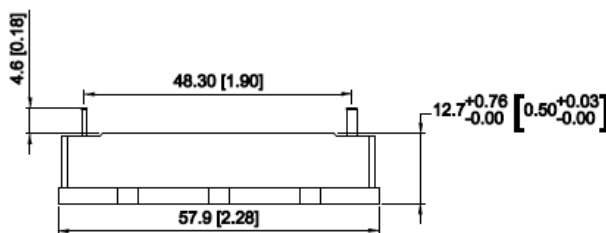
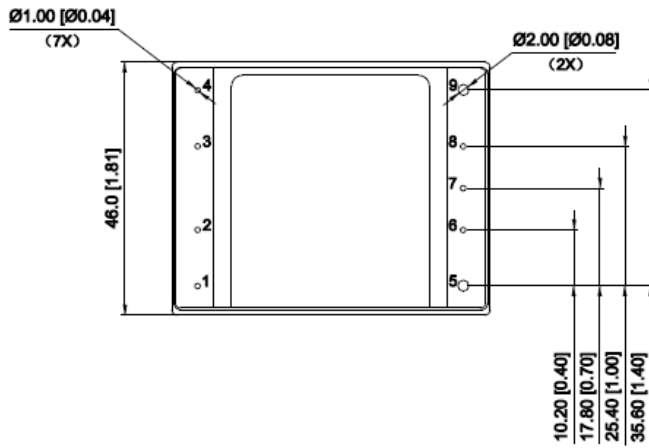
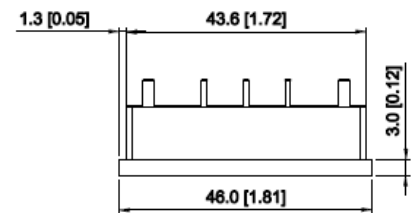
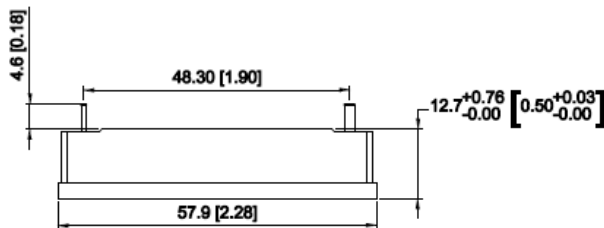

Figure 20 the pin function and mechanical drawing

MECHANICAL DRAWING(WITHOUT MOUNTING HOLE)



PIN #	Function
1	+In
2	Gate In
3	Gate out
4	-In
5	+Out
6	+Sense
7	Trim
8	-Sense
9	-Out



DIMENSIONAL TOLERANCE

X	$\pm 0.3\text{mm}$
x.x	$\pm 0.2\text{mm}$
x.xx	$\pm 0.1\text{mm}$



PART NUMBERING SYSTEM

H	A1	S	V	24	002	N	N	F	A
Form Factor	Input Voltage	Number of Outputs	Product Series Number	Output Voltage	Output Current	ON/OFF Logic	Pin Length		Option Code
H - Half Brick	110- 53V~154V	S - Single	V- Series Number	24- 24V	002- 2.1A	N - Negative P - Positive	N - 0.145" R - 0.170" M - SMD pin	F - RoHS 6/6 (Lead Free) Space - RoHS5/6	A - Baseplate H--without mounting hole

MODEL LIST

MODEL NAME	INPUT		OUTPUT		EFF @ 100% LOAD
HA1SV24002PRFA	53V~154V	1.13A	24V	2.1A	87%
HA1SV24002PRFH	53V~154V	1.13A	24V	2.1A	87%

Default remote on/off logic is negative and pin length is 0.170"

For different remote on/off logic and pin length, please refer to part numbering system above or contact your local sales office.

For modules with through-hole pins and the optional heatspreader, they are intended for wave soldering assembly onto system boards; please do not subject such modules through reflow temperature profile.

CONTACT: www.deltaww.com/dcdc

Email: dcdc@deltaww.com

USA:

Telephone:
East Coast: 978-656-3993
West Coast: 510-668-5100
Fax: (978) 656 3964

Europe:

Phone: +31-20-655-0967
Fax: +31-20-655-0999

Asia & the rest of world:

Telephone: +886 3 4526107
ext 6220~6224
Fax: +886 3 4513485

WARRANTY

Delta offers a two (2) year limited warranty. Complete warranty information is listed on our web site or is available upon request from Delta.

Information furnished by Delta is believed to be accurate and reliable. However, no responsibility is assumed by Delta for its use, nor for any infringements of patents or other rights of third parties, which may result from its use. No license is granted by implication or otherwise under any patent or patent rights of Delta. Delta reserves the right to revise these specifications at any time, without notice.