

Contents

	Page
Description of the Han-Modular® system	06.03
Summary Han-Modular®	06.04
Han-Modular® Compact	06.08
Han-Modular® Twin	06.10
Han-Modular® Hinged frames	06.12
Han-Modular® Docking frames	06.14
Han-Modular® ECO	06.16
Han® 200 A Axial module	06.20
Han® 200 A Crimp module	06.22
Han® 100 A Axial module	06.24
Han® 100 A Crimp module	06.26
Han® 70 A Axial module	06.28
Han® 40 A Axial module	06.30
Han® 40 A Crimp module	06.32
Han® C Axial module	06.34
Han® C module	06.36
Han® CC Protected module	06.38
Han® CD module	06.40
Han E® module	06.42
Han® EE module	06.44
Han® EE Quick Lock module	06.46
Han E® Protected module	06.48
Han® EEE module	06.50
Han® ES module	06.52
Han® HV module	06.54
Han DD® module	06.58
Han DD® Quick Lock module	06.60
Han® DDD module	06.62
Han® High Density module	06.64
Han® D-Sub module	06.66
Han® USB module	06.68
Han® FireWire module	06.70
Han® RJ45 module	06.72
Han® GigaBit module	06.78
Han-Quintax® module	06.82
Han® Coax module	06.84
Han® Multi Contact module according to DIN 41 626	06.86
Han® Multi Contact module according to D-Sub	06.88
Han® Pneumatic module	06.90
Han® SC module	06.94

Han-Elisa®	06. 96
Han-Elisa® Pt100 Modul	06. 98
Han-Elisa® Output module	06.100
Han-Elisa® ID module	06.102
Han-Modular® Accessories	06.104

Description of the Han-Modular® system

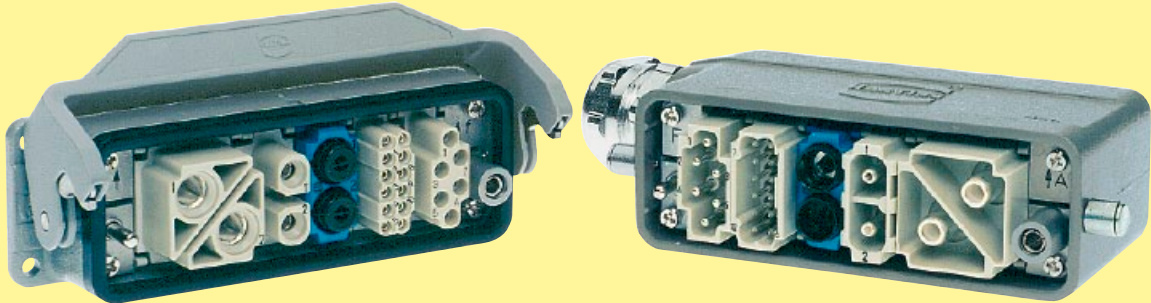

The Han-Modular® series is a new system of inserts designed to meet the specific requirements of individual customers. In close cooperation with potential users a range of modular inserts have been developed allowing the simple assembly of custom designed complete connectors which meet the diverse requirements encountered by designers today.

Han-Modular® is a logical development of the Han-Com® series which already offers the combination of power and signal circuits in one connector.

The individual modules of this series now allow the integration of electrical, optical and gaseous signal and power connections in one connector assembly.

The pneumatic contacts are also suitable for the connection of liquid media. However it must be stated that a combination of electrical and liquid connections in one connector is not allowed according to VDE regulations.

The individual contacts used in this system are all from existing well proven ranges and it is possible to use combinations of 1 to 12 modules depending on the size of the hoods and housings chosen.

The basic modules snap into a mounting frame and can be exchanged separately at any time.

Advantages:

- Custom designs can be simply assembled
- Optimum solutions can be reached
- Stock can be minimized

Assembly details

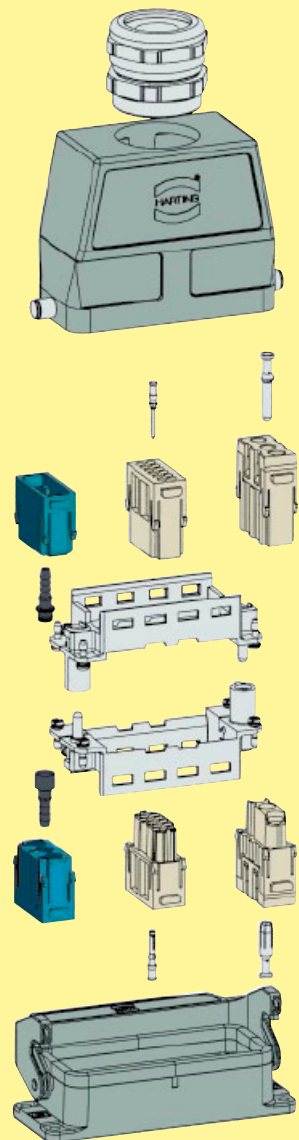

Han-Modular® Compact

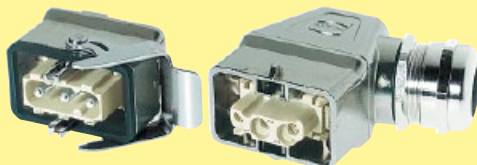

Page 06.08

Han-Modular® Twin



Page 06.10

Han-Modular® Hinged frames in Han® B hoods and housings

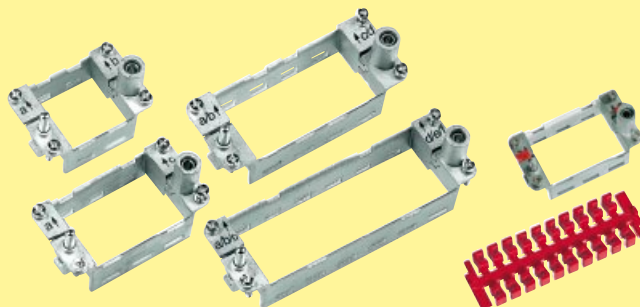

Page 06.12

Han-Modular® Docking frame

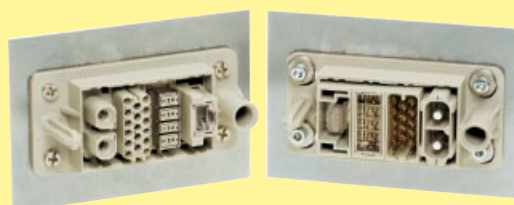



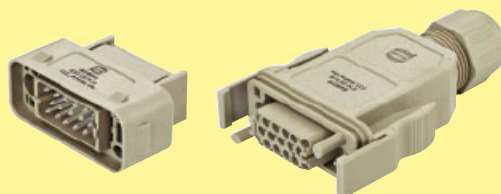

Page 06.14



Han-Modular® ECO





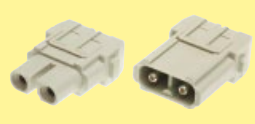

Page 06.16





Han
Modular





Series	Han® 200 A Axial module	Han® 200 A Crimp module	Han® 100 A Axial module	Han® 100 A Crimp module
Number of contacts	1	1	2	2
Modules	Axial screw terminal 	Crimp terminal 	Axial screw terminal 	Crimp terminal 
Rated current	200 A	200 A	100 A	100 A
Rated voltage	1000 V	1000 / 1000 V	1000 V	1000 V
Wire gauge	25 ... 70 mm ²	25 ... 70 mm ²	10 ... 38 mm ²	10 ... 35 mm ²
Page	06.20	06.22	06.24	06.26





Series	Han® 70 A Axial module	Han® 40 A Axial module	Han® 40 A Crimp module	Han® C Axial module
Number of contacts	2	2	2	3
Modules	Axial screw terminal 	Axial screw terminal 	Crimp terminal 	Axial screw terminal 
Rated current	70 A	40 A	40 A	40 A
Rated voltage	1000 V	1000 V	1000 V	690 V
Wire gauge	6 ... 22 mm ²	2.5 ... 10 mm ²	1.5 ... 10 mm ²	2.5 ... 10 mm ²
Page	06.28	06.30	06.32	06.34





Han
Modular





Series	Han® C module	Han® CC Protected module	Han® CD module	Han E® module
Number of contacts	3	4	3 / 4	6
Modules	Crimp terminal 	Crimp terminal 	Crimp terminal 	Crimp terminal 
Rated current	40 A	40 A	40 A / 10 A	16 A
Rated voltage	400 / 690 V	830 V	830 V / 830 V	500 V
Wire gauge	1.5 ... 10 mm ²	1.5 ... 6 mm ²	1.5 ... 6 mm ² / 0.14 ... 2.5 mm ²	0.14 ... 4 mm ²
Page	06.36	06.38	06.40	06.42

Series	Han® EE module	Han® EE Quick Lock module	Han E® Protected module	Han® EEE module
Number of contacts	8	8	6	20
Modules	Crimp terminal 	Quick Lock terminal 	Crimp terminal 	Crimp terminal 
Rated current	16 A	16 A	16 A	16 A
Rated voltage	400 V	400 V	830 V	500 V
Wire gauge	0.14 ... 4 mm ²	0.5 ... 2.5 mm ²	0.14 ... 4 mm ²	0.14 ... 4 mm ²
Page	06.44	06.46	06.48	06.50

Series	Han® ES module	Han® HV module	Han® HV module	Han DD® module
Number of contacts	5	2	2	12
Modules	Cage-clamp terminal 	Crimp terminal 	Crimp terminal 	Crimp terminal 
Rated current	16 A	16 A	40 A	10 A
Rated voltage	400 V	2900 / 5000 V	2900 / 5000 V	250 V
Wire gauge	0.14 ... 2.5 mm ²	0.5 ... 4 mm ²	1.5 ... 10 mm ²	0.14 ... 2.5 mm ²
Page	06.52	06.54	06.56	06.58

Series	Han DD® Quick Lock module	Han® DDD module	Han® High Density module	Han® D-Sub module
Number of contacts	12	17	25	9
Modules	Quick Lock terminal 	Crimp terminal 	Crimp terminal 	Crimp terminal 
Rated current	10 A	10 A	4 A	5 A
Rated voltage	250 V	160 V	50 V	50 V
Wire gauge	0.25 ... 1.5 mm ²	0.14 ... 2.5 mm ²	0.08 ... 0.52 mm ²	0.08 ... 0.52 mm ²
Page	06.60	06.62	06.64	06.66

Series	Han® USB module	Han® FireWire module	Han® RJ45 module	Han® GigaBit module
Number of contacts	4	6	8	8
Modules	USB 2.0 	IEEE 1394 	Ethernet Cat. 5e 	Ethernet Cat. 6 
Page	06.68	06.70	06.72	06.78

Series	Han-Quintax® module				Han® Multi Contact module	
Number of contacts	2				4	
Modules						
Page	06.82		06.84		06.86	06.88
Contacts	Quintax contact 4 + shielding	High Density Quintax contact 8 + shielding	Han D® D Coax contact 1 + shielding	Han E® E Coax contact 1 + shielding	FOC contacts	Coaxial contact
						
			75 Ω	50 Ω	Multimode F.O. HCS®*/PCF F.O. 1 mm POF	50 Ω RG 174 75 Ω RG 179 50 Ω RG 58

Series	Han® Pneumatic module		Han® SC module	Han-Elisa®	Dummy module
Number of contacts	2	3	4		
Modules					
Page	06.90	06.92	06.94	06.96	06.104
Contacts	 Ø 6.0 mm	 Ø 1.6 mm Ø 3.0 mm Ø 4.0 mm	 SC contact	Temperature I/O modules ID module	

Features

- Compact design saves space
- Modular structure increases flexibility
- Simple and quick assembly
- Robust design
- Two part grommet housing

Technical characteristics

Hoods/Housings

Material	zinc die-cast
Surface	nickel plated
Locking element	stainless steel
Hoods/Housings sealing	NBR
Limiting temperatures	-40 °C ... +125 °C
Degree of protection acc. to DIN EN 60 529	
for coupled connector	IP 65
Mechanical working life	
- mating cycles	500
PE contact	
wire gauge	10 mm ² / AWG 8
Stripping length	10 mm
Tightening torque	1 Nm

Protection covers for housings, bulkhead mounting

Material	polycarbonate
Locking element	Polyamide
Hoods/Housings sealing	NBR
Limiting temperatures	-40 °C ... +125 °C
Degree of protection acc. to DIN EN 60 529	
for coupled connector	IP 65
Flammability acc. to UL 94	V 0

Current carrying capacity

The current carrying capacity of the connectors is limited by the thermal load capability of the contact element material including the connections and the insulating parts. The derating curve is therefore valid for currents which flow constantly (non-intermittent) through each contact element of the connector evenly, without exceeding the allowed maximum temperature.

Measuring and testing techniques according to DIN EN 60 512-5

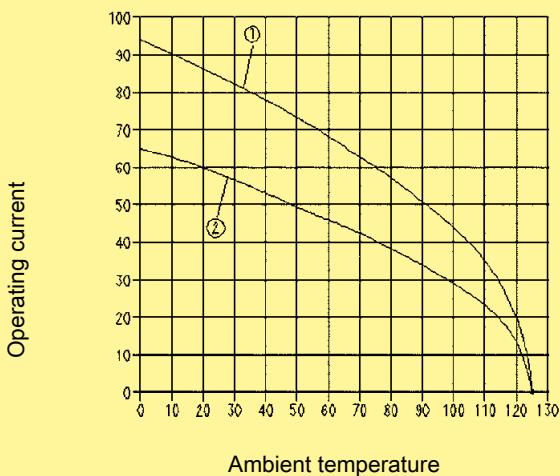

① Han® Axial screw module, Wire gauge: 10 mm²

② Han® C module, Wire gauge: 6 mm²

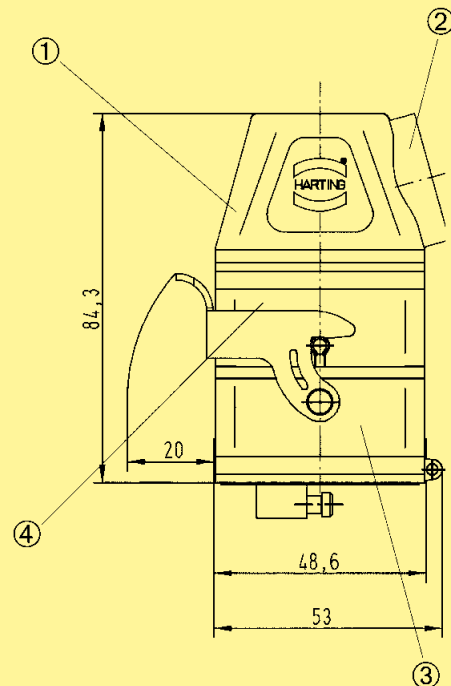







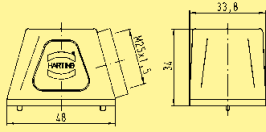

① Hood with side entry

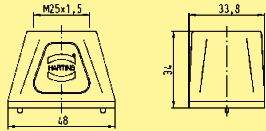
② Thread M25

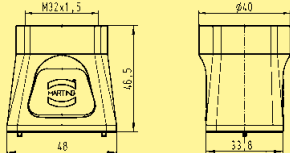
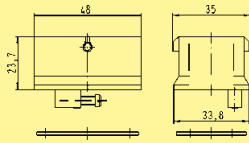
③ Bulkhead mounted housing with locking lever

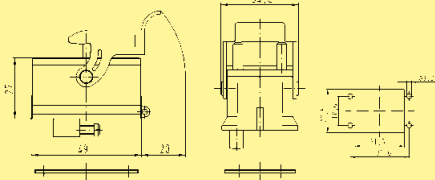
④ Carrier hood

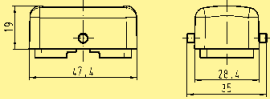
Identification	Part number	Drawing	Dimensions in mm
Hoods side entry M25 	19 14 001 0501	4 screws are included in the delivery range 	
Hoods top entry M25 	19 14 001 0401	4 screws are included in the delivery range 	
Hoods top entry M32 	19 14 001 0402	4 screws are included in the delivery range 	
Carrier hood 	09 14 001 0311		
Protection covers 	09 14 001 5402		
Housings, bulkhead mounting 	09 14 001 0301		Panel cut out
Protection covers for housings, bulkhead mounting 	09 14 001 5401		

Features

- Compact and space saving
- High degree of flexibility due to modular assembly
- Easy and quick assembly
- Robust design
- Hood consists of two parts

Technical characteristics

Hoods/Housings

Material	aluminium die-cast
Surface	powder-coated
Locking element	Han-Easy Lock®
Material	
Panel feed through housing / Shielding frame	zinc die-cast
Hoods/Housings seal	NBR
Limiting temperatures	-40 °C ... +125 °C
Degree of protection acc. to DIN EN 60 529	
for coupled connector	IP 65
Mechanical working life	
- mating cycles	≥ 500
PE contact	
wire gauge	10 mm ² / AWG 8
Stripping length	10 mm
Tightening torque	1 Nm

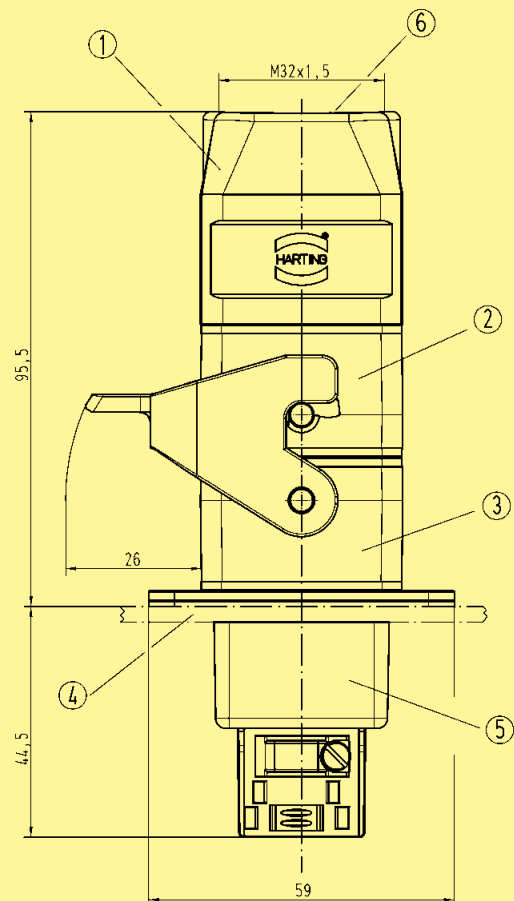

- ① Hood with top entry
- ② Carrier hood
- ③ Bulkhead mounted housing with locking lever
- ④ Switch board panel
- ⑤ Split Hood
- ⑥ Thread M32



Identification	Part number	Drawing	Dimensions in mm
Hoods top entry M32	19 14 002 0402		
Shielding frame	09 14 000 9924		
Carrier hood	09 14 002 0311		
Housings, bulkhead mounting	09 14 002 0301		Panel cut out
Panel feed through housings	09 14 000 9928		Panel cut out

Features

- Pre-leading grounding system according VDE
- Modules can only be assembled polarized to guarantee a correct orientation
- Alphabetical marking of module position
- High mechanical reliability of modules in case of vibration and impact stress
- No tools necessary to remove modules

Technical characteristics

Specifications DIN EN 60 664-1
 DIN EN 61 984

Approvals 

Hinged frames

Number of modules	2, 3, 4, 6
PE contact	
Wire gauge	
- Power side *	4 ... 10 mm ² AWG 12 ... 8
- Signal side	1 ... 2.5 mm ² AWG 18 ... 14
Material	zinc die-cast
Limiting temperatures	-40 °C ... +125 °C
Mechanical working life	
- mating cycles	≥ 500







Hoods/Housings

Selection of hoods/housings	see chapter 30 / chapter 31
Material	aluminium die-cast
Surface	powder-coated RAL 7037
Locking element	Han-Easy Lock®
Hoods/Housings seal	NBR
Limiting temperatures	-40 °C ... +125 °C
Degree of protection acc. to DIN EN 60 529	
for coupled connector	IP 65

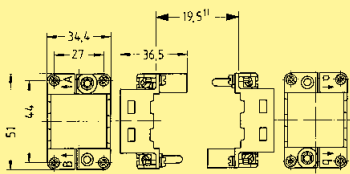
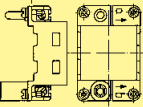
Accessories

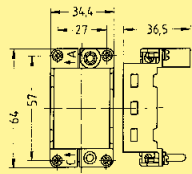
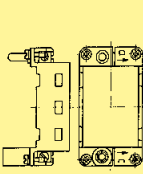
Coding of hoods/housings	chapter 40
--------------------------	------------

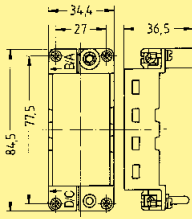
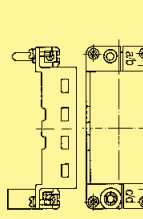

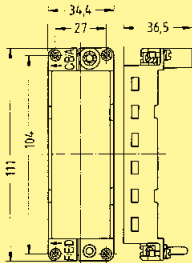
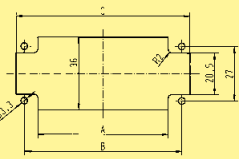
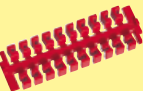
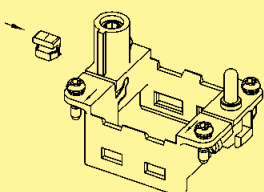
Identification	Part number for Hood/Housing 2)			Drawing	Dimensions in mm																				
	Size	Marking A ... F	Marking a ... f																						
Hinged frame for 2 modules 	6 B	09 14 006 0303	09 14 006 0313	Hoods 	Housings 																				
Hinged frame for 3 modules 	10 B	09 14 010 0303	09 14 010 0313																						
Hinged frame for 4 modules 	16 B	09 14 016 0303	09 14 016 0313																						
Hinged frame for 6 modules 	24 B	09 14 024 0303	09 14 024 0313	 Panel cut out 	<table border="1"> <thead> <tr> <th>Size</th> <th>A</th> <th>B</th> <th>C</th> </tr> </thead> <tbody> <tr> <td>6 B</td> <td>35</td> <td>44</td> <td>52</td> </tr> <tr> <td>10 B</td> <td>49</td> <td>57</td> <td>66</td> </tr> <tr> <td>16 B</td> <td>64</td> <td>77.5</td> <td>85.5</td> </tr> <tr> <td>24 B</td> <td>94</td> <td>104</td> <td>112</td> </tr> </tbody> </table>	Size	A	B	C	6 B	35	44	52	10 B	49	57	66	16 B	64	77.5	85.5	24 B	94	104	112
Size	A	B	C																						
6 B	35	44	52																						
10 B	49	57	66																						
16 B	64	77.5	85.5																						
24 B	94	104	112																						
Locking element for hinged frames (20 pieces per bloc) 		09 14 000 9960	09 14 000 9960		Ideal to pre-assemble the hinged frames																				

1) Distance max. 20.5 mm
 2) Hinged frames can be used either in hood or housing
 Both different markings must be used for one connector!

Features

- Blind mating connector system for drawer systems
- Direct panel mounting without housing
- Very robust design
- Solid pre-leading guid pins and float bushes
- Can be fixed with standard M4 screws

Notice:

Due the plastic material used in the docking frame without PE, the panel will need to be grounded separately







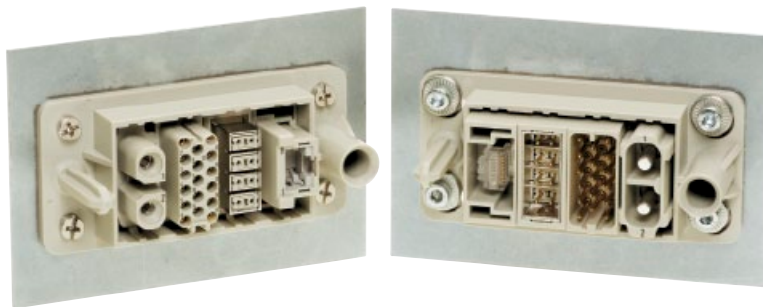

Technical characteristics

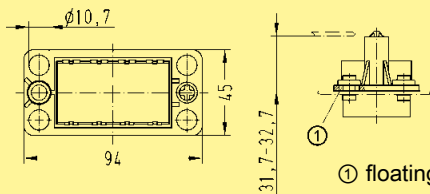
Specifications	DIN EN 60 664-1 DIN EN 61 984
----------------	----------------------------------

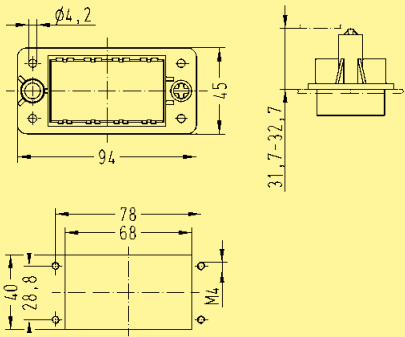
Docking frames

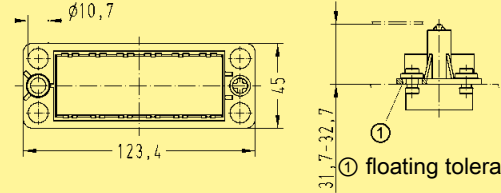
Number of modules	4, 6
Material	
- Docking frames	polycarbonate
- Float washer	zinc die-cast
Floating tolerance	± 2 mm
Limiting temperatures	-40 °C ... +125 °C
Flammability acc. to UL 94	V 0
Mechanical working life	
- mating cycles	≥ 500

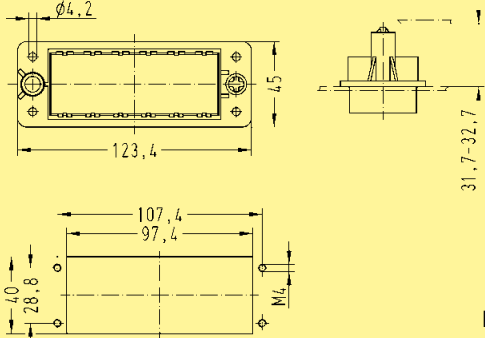

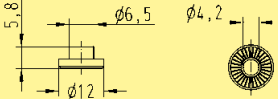
Identification	Part number		Drawing	Dimensions in mm
	Marking A ... F ¹⁾	Marking a ... f ²⁾		
Docking frame for 4 modules 	09 14 016 1701		 <p>① floating tolerance ±2 mm</p>	
Docking frame for 4 modules 		09 14 016 1711	 <p>Panel cut out</p>	
Docking frame for 6 modules 	09 14 024 1701		 <p>① floating tolerance ±2 mm</p>	
Docking frame for 6 modules 		09 14 024 1711	 <p>Panel cut out</p>	
Float washer to enable the frame to be float mounted using standard M4 fixing screws 	09 14 000 9936			

1) Float mount
2) Fixed

Features

- Suitable for all Han-Modular® single modules
- The variant with PE connection uses pin 1 of the module as PE
- Slim, space saving design
- Low cost plastic hoods and housings

Technical characteristics





Specifications	DIN EN 60 664-1 DIN EN 61 984
----------------	----------------------------------

Hoods/Housings

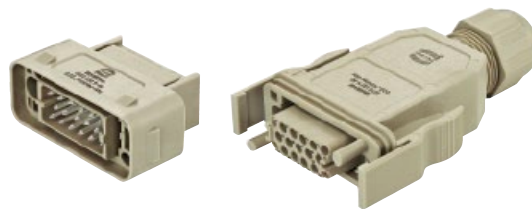
Material	
- Hoods/Housings	polycarbonate
- Seal	NBR
- Cable seal	Polyamide
Limiting temperatures	-40 °C ... +85 °C
Flammability acc. to UL 94	V 0
Degree of protection acc. to DIN EN 60 529 for coupled connector	IP 20 / IP 65
Mechanical working life	
- mating cycles	≥ 500

Plastic hoods/housings
with PE marking



Identification	Part number	Drawing	Dimensions in mm
Hoods with PE marking (pin 1 = PE) IP 65 top entry 	09 14 001 0421		
Hoods with PE marking (pin 1 = PE) IP 20 top entry 	09 14 001 0423		
Hoods with PE marking (pin 1 = PE) IP 20 / IP 65 top entry 	09 14 001 0321		Panel cut out
Coding pin 	09 14 000 9929		Range of delivery: 8 pieces per frame

Han
Modular

Plastic hoods/housings
without PE

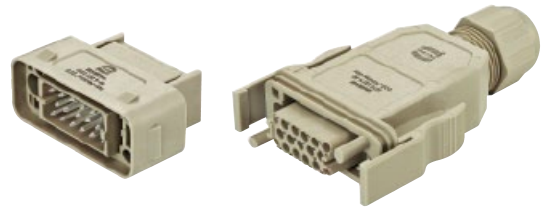

Han
Modular

Identification	Part number	Drawing	Dimensions in mm
Hoods without PE IP 65 top entry	09 14 001 0420		
Hoods without PE IP 20 top entry	09 14 001 0422		
Hoods without PE IP 20 / IP 65 top entry	09 14 001 0320		Panel cut out
Coding pin	09 14 000 9929		Range of delivery: 8 pieces per frame

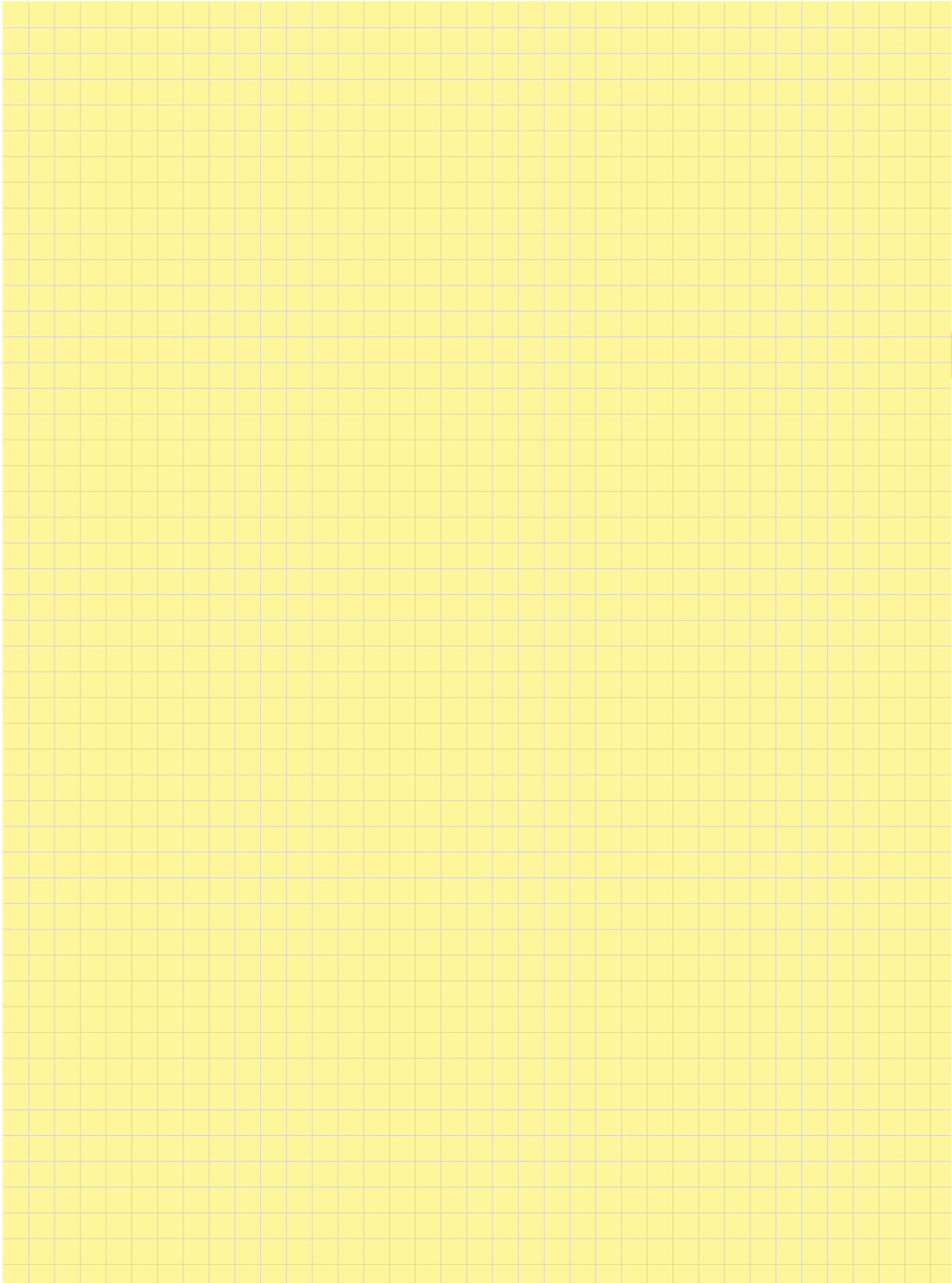

Features

- Axial-screw termination
- No special tools required
- Power module for big wire gauge up to 70 mm²
- Suitable as a 3 + PE connector in a Han® 32 B housing
- Compatible to the Han® 200 A module with crimp terminal

Technical characteristics

Specifications DIN EN 60 664-1
DIN EN 61 984

Approvals

Inserts

Number of contacts 1
 Electrical data
 acc. to EN 61 984 **200 A 1000 V 8 kV 3**
 Rated current 200 A
 Rated voltage 1000 V
 Rated impulse voltage 8 kV
 Pollution degree 3

Rated voltage
 acc. to UL 600 V
 Insulation resistance ≥ 10¹⁰ Ω
 Material polycarbonate
 Limiting temperatures -40 °C ... +125 °C
 Flammability acc. to UL 94 V 0
 Mechanical working life
 - mating cycles ≥ 500

Contacts

Material copper alloy
 Surface
 - hard-silver plated 3 μm Ag
 Contact resistance 0.2 mΩ
 Screw terminal
 - Wire gauge ¹⁾ 25 ... 70 mm²
 - AWG 2 ... 00
 - Hexagonal driver SW 5
 - Stripping length 16 mm
 - Tightening torque

mm ²	25	35	50	70
Nm	8	8	9	10

Current carrying capacity

The current carrying capacity of the connectors is limited by the thermal load capability of the contact element material including the connections and the insulating parts. The derating curve is therefore valid for currents which flow constantly (non-intermittent) through each contact element of the connector evenly, without exceeding the allowed maximum temperature.

Measuring and testing techniques according to DIN EN 60 512-5

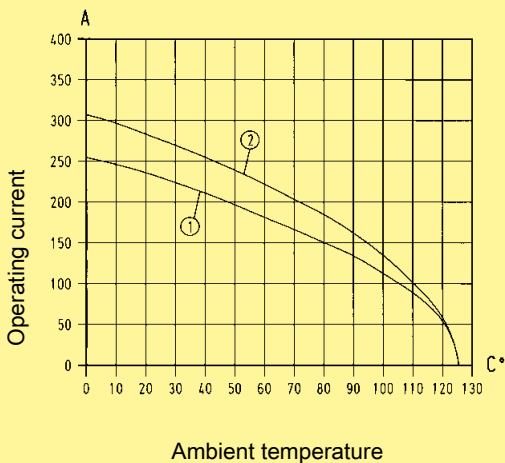

① 24 B hoods/housings with 3 modules; wire gauge: 50 mm²

② 24 B hoods/housings with 3 modules; wire gauge: 70 mm²

1) geometric wire gauge

Number of contacts

1

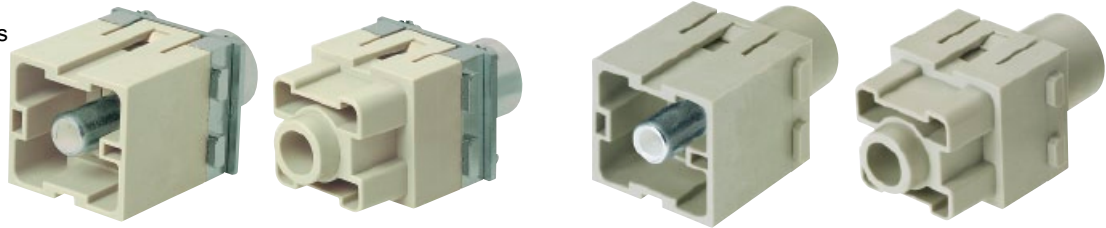

Identification	Part number		Drawing	Dimensions in mm
	Male insert (M)	Female insert (F)		
Axial screw terminal 200 A				
25 ... 40 mm ²	09 14 001 2663	09 14 001 2763		
40 ... 70 mm ²	09 14 001 2662	09 14 001 2762		
Axial screw terminal 200 A PE (Ground)				
25 ... 40 mm ²	09 14 001 2668	09 14 001 2768		
40 ... 70 mm ²	09 14 001 2667	09 14 001 2767		

Han
Modular

Identification	Part number	Drawing	Dimensions in mm
Hex key SW 5 for axial setscrew			
with grip	09 99 000 0364		
adapter 3/8"	09 99 000 0371		



Features

- Crimp termination
- Contacts can be unlocked from the mating side
- Compatible with Han® 200 A modules with axial screw terminal

Technical characteristics

Specifications	EN 50 124-1 DIN EN 60 664-1 DIN EN 61 984
----------------	---

Inserts

Number of contacts	1
Electrical data acc. to EN 61 984	200 A 1000 V 8 kV 3
Rated current	200 A
Rated voltage	1000 V
Rated impulse voltage	8 kV
Pollution degree	3
Insulation resistance	$\geq 10^{10} \Omega$
Material	polycarbonate
Limiting temperatures	-40 °C ... +125 °C
Flammability acc. to UL 94	V 0
Mechanical working life - mating cycles	≥ 500

Contacts

Material	copper alloy
Surface	
- hard-silver plated	3 μm Ag
Contact resistance	$\leq 0.3 \text{ m}\Omega$
Crimp terminal	
- mm^2	25 ... 70 mm^2
Stripping length	22.5 mm
Max. insulation diameter	18 mm

Current carrying capacity

The current carrying capacity of the connectors is limited by the thermal load capability of the contact element material including the connections and the insulating parts. The derating curve is therefore valid for currents which flow constantly (non-intermittent) through each contact element of the connector evenly, without exceeding the allowed maximum temperature.

Measuring and testing techniques according to DIN EN 60 512-5

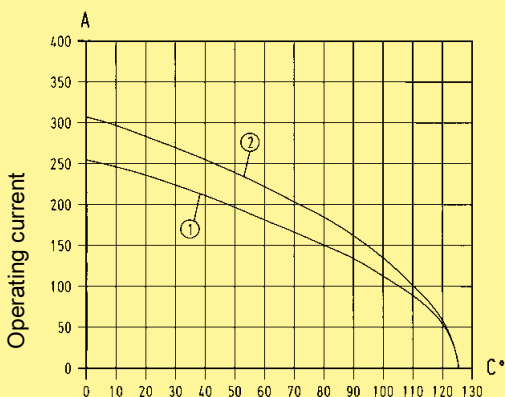

Ambient temperature

- ① 24 B hoods/housings with 3 modules; wire gauge: 50 mm^2
 ② 24 B hoods/housings with 3 modules; wire gauge: 70 mm^2

Number of contacts

1

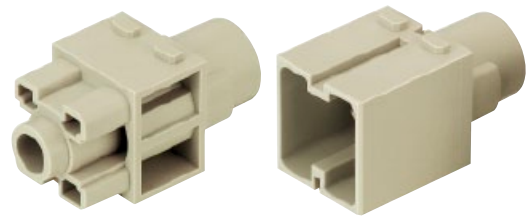

Identification	Part number		Drawing	Dimensions in mm
	Male insert (M)	Female insert (F)		
Crimp terminal Modul	09 14 001 3001	09 14 001 3101		

Han
Modular

Identification	Wire gauge (mm ²)	Part number		Drawing	Dimensions in mm
		Male contact	Female contact		
Crimp contacts silver plated					
	25	09 11 000 6120	09 11 000 6220		
	35	09 11 000 6121	09 11 000 6221		
	50	09 11 000 6122	09 11 000 6222		
	70	09 11 000 6123	09 11 000 6223		

Wire gauge	∅	Stripping length
25 mm ²	7	22.5 mm
35 mm ²	8.2	22.5 mm
50 mm ²	10	22.5 mm
70 mm ²	11.5	22.5 mm

for stranded wire according to IEC 60 228 Class 5

Number of contacts

2

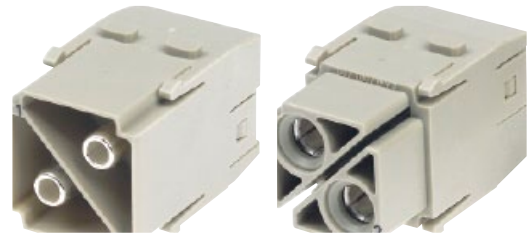

Identification	Part number		Drawing	Dimensions in mm
	Male insert (M)	Female insert (F)		
Axial screw terminal 100 A				
10 ... 25 mm ²	09 14 002 2653	09 14 002 2753		
16 ... 35 mm ²	09 14 002 2651	09 14 002 2751		
38 mm ²	09 14 002 2650	09 14 002 2750		

Han
Modular

Identification	Part number	Drawing	Dimensions in mm
Hex key SW 4 for axial setscrew			
with grip	09 99 000 0363		
adapter 3/8"	09 99 000 0370		
Cable shoe 16 mm ² for PE extension			<p>Please use pressing tools for non-insulated cable shoes following DIN 46 230 with 16 mm² range (eg. K25, co. Klauke)</p>
Comment for hoods/ housings high construction only	09 14 000 9912		

Stock items in bold type

Features

- Crimp termination
- Unlock of contacts from mating side
- Connect PE contact with special cable shoe
- Compatible to Han® 100 A module with axial screw terminal

Technical characteristics

Specifications DIN EN 60 664-1
 DIN EN 61 984

Approvals

Inserts

Number of contacts 2
 Electrical data
 acc. to EN 61 984 **100 A 1000 V 8 kV 3**
 Rated current 100 A
 Rated voltage 1000 V
 Rated impulse voltage 8 kV
 Pollution degree 3

Insulation resistance $\geq 10^{10} \Omega$
 Material polycarbonate
 Limiting temperatures -40 °C ... +125 °C
 Flammability acc. to UL 94 V 0
 Mechanical working life
 - mating cycles ≥ 500

Contacts

Material copper alloy
 Surface
 - hard-silver plated 3 μm Ag
 Contact resistance $\leq 0.3 \text{ m}\Omega$
 Crimp terminal
 - mm^2 10 ... 35 mm^2
 Max. cable diameter 14 mm

Crimp zone (C)

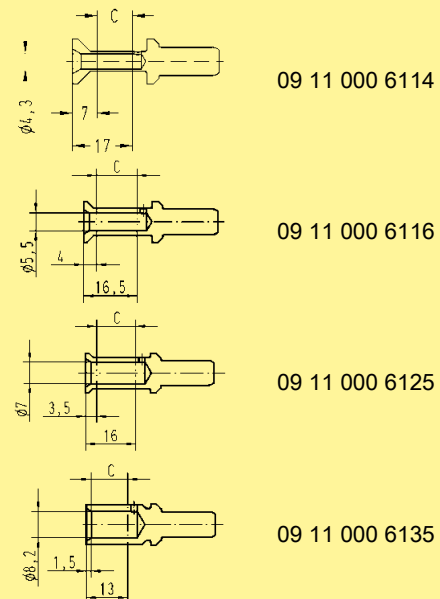

Current carrying capacity

The current carrying capacity of the connectors is limited by the thermal load capability of the contact element material including the connections and the insulating parts. The derating curve is therefore valid for currents which flow constantly (non-intermittent) through each contact element of the connector evenly, without exceeding the allowed maximum temperature.

Measuring and testing techniques according to DIN EN 60 512-5

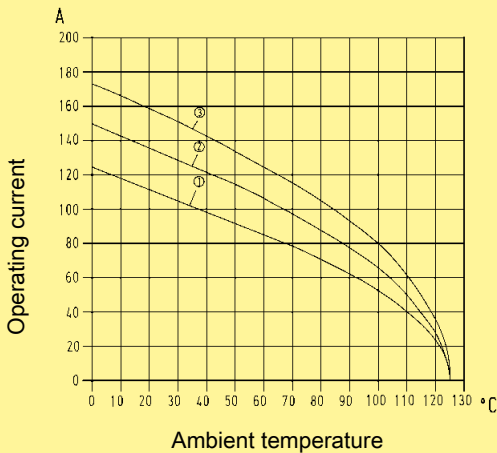

- ① 24 B hoods/housings with 3 modules; wire gauge: 16 mm^2
- ② 24 B hoods/housings with 3 modules; wire gauge: 25 mm^2
- ③ 24 B hoods/housings with 3 modules; wire gauge: 35 mm^2

Number of contacts

2

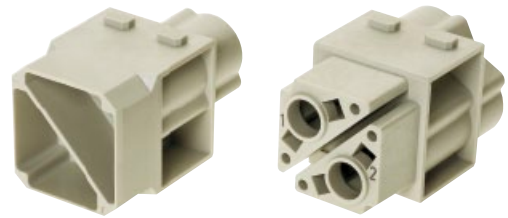

Identification	Part number		Drawing	Dimensions in mm
	Male insert (M)	Female insert (F)		
Crimp terminal Modul	09 14 002 3051	09 14 002 3151		
Removal tool for TC contacts	09 99 000 0383	09 99 000 0383		

Han Modular

Identification	Wire gauge (mm ²)	Part number		Drawing	Dimensions in mm															
		Male contact	Female contact																	
Crimp contacts silver plated																				
	10	09 11 000 6114	09 11 000 6214																	
	16	09 11 000 6116	09 11 000 6216																	
	25	09 11 000 6125	09 11 000 6225																	
	35	09 11 000 6135	09 11 000 6235																	
				<table border="1"> <thead> <tr> <th>Wire gauge</th> <th>∅</th> <th>Stripping length</th> </tr> </thead> <tbody> <tr> <td>10 mm²</td> <td>4.3</td> <td>19 mm</td> </tr> <tr> <td>16 mm²</td> <td>5.5</td> <td>19 mm</td> </tr> <tr> <td>25 mm²</td> <td>7</td> <td>19 mm</td> </tr> <tr> <td>35 mm²</td> <td>8.2</td> <td>16 mm</td> </tr> </tbody> </table>	Wire gauge	∅	Stripping length	10 mm ²	4.3	19 mm	16 mm ²	5.5	19 mm	25 mm ²	7	19 mm	35 mm ²	8.2	16 mm	
Wire gauge	∅	Stripping length																		
10 mm ²	4.3	19 mm																		
16 mm ²	5.5	19 mm																		
25 mm ²	7	19 mm																		
35 mm ²	8.2	16 mm																		
				for stranded wire according to IEC 60 228 Class 5																

Stock items in bold type

Features

- Axial-screw termination
- 2 contacts (70 A) for power circuits
- Male inserts with protection collar
- Polarisation of module
- Male and female contacts are finger safe

Technical characteristics

Specifications DIN EN 60 664-1
DIN EN 61 984

Approvals

Inserts

Number of contacts 2
 Electrical data
 acc. to EN 61 984 **70 A 1000 V 8 kV 3**
 Rated current 70 A
 Rated voltage 1000 V
 Rated impulse voltage 8 kV
 Pollution degree 3

Rated voltage
 acc. to UL 600 V
 Insulation resistance ≥ 10¹⁰ Ω
 Material polycarbonate
 Limiting temperatures -40 °C ... +125 °C
 Flammability acc. to UL 94 V 0
 Mechanical working life
 - mating cycles ≥ 500

Contacts

Material copper alloy
 Surface - hard-silver plated
3 μm Ag
 Contact resistance 0.5 mΩ
 Screw terminal
 - Wire gauge ¹⁾ 6 ... 22 mm²
 - AWG 8 ... 4
 - Hexagonal driver SW 2.5
 - Stripping length

mm ²	6	10	16	22
mm	11 ⁺¹	11 ⁺¹	11 ⁺¹	12.5 ⁺¹

- Tightening torque

mm ²	6	10	16	22
Nm	2	3	4	5

Current carrying capacity

The current carrying capacity of the connectors is limited by the thermal load capability of the contact element material including the connections and the insulating parts. The derating curve is therefore valid for currents which flow constantly (non-intermittent) through each contact element of the connector evenly, without exceeding the allowed maximum temperature.

Measuring and testing techniques according to DIN EN 60 512-5

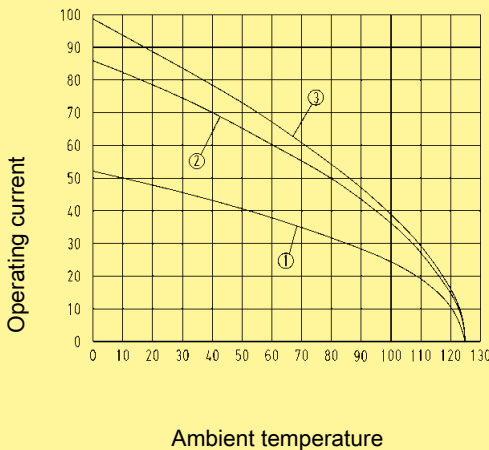

- ① 24 B hoods/housings with 6 modules; wire gauge: 6 mm²
- ② 24 B hoods/housings with 6 modules; wire gauge: 16 mm²
- ③ 24 B hoods/housings with 6 modules; wire gauge: 22 mm²

1) geometric wire gauge

Number of contacts

2

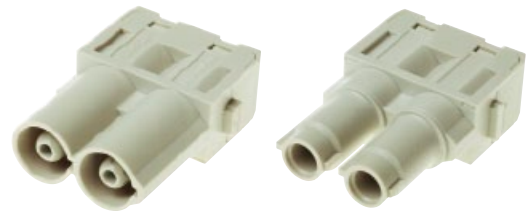

Identification	Part number		Drawing	Dimensions in mm
	Male insert (M)	Female insert (F)		
Axial screw terminal 70 A				
6 ... 16 mm ²	09 14 002 2646	09 14 002 2741		
14 ... 22 mm ²	09 14 002 2647	09 14 002 2742		
Axial screw terminal 70 A with finger protected male contacts				
6 ... 16 mm ²	09 14 002 2641			
14 ... 22 mm ²	09 14 002 2642			

Han
Modular

Identification	Part number	Drawing	Dimensions in mm
Hex key SW 2.5 for axial setscrew			
Bit 1/4"	09 99 000 0375		



Features

- Axial-screw termination
- No special tools required
- Compatible to Han® 40 A module with crimp terminal

Technical characteristics

Specifications DIN EN 60 664-1
DIN EN 61 984

Approvals

Inserts

Number of contacts 2
 Electrical data
 acc. to EN 61 984 **40 A 1000 V 8 kV 3**
 Rated current 40 A
 Rated voltage 1000 V
 Rated impulse voltage 8 kV
 Pollution degree 3

Rated voltage
 acc. to UL 600 V
 Insulation resistance ≥ 10¹⁰ Ω
 Material polycarbonate
 Limiting temperatures -40 °C ... +125 °C
 Flammability acc. to UL 94 V 0
 Mechanical working life
 - mating cycles ≥ 500

Contacts

Material copper alloy

Surface
 - hard-silver plated 3 μm Ag

Contact resistance 0.5 mΩ

Screw terminal 2.5 ... 10 mm²

- Wire gauge ¹⁾ 14 ... 8

- AWG SW 2

- Hexagonal driver

- Stripping length

mm ²	2.5	4	6	10
mm	5 ⁺¹	5 ⁺¹	8 ⁺¹	11 ⁺¹

- Tightening torque

mm ²	2.5	4	6	10
Nm	1.5	1.5	2	2

Current carrying capacity

The current carrying capacity of the connectors is limited by the thermal load capability of the contact element material including the connections and the insulating parts. The derating curve is therefore valid for currents which flow constantly (non-intermittent) through each contact element of the connector evenly, without exceeding the allowed maximum temperature.

Measuring and testing techniques according to DIN EN 60 512-5

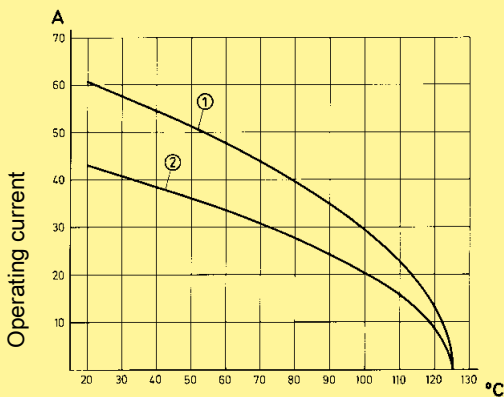

Ambient temperature

① 24 B hoods/housings with 6 modules; wire gauge: 10 mm²

② 24 B hoods/housings with 6 modules; wire gauge: 6 mm²

Number of contacts

2

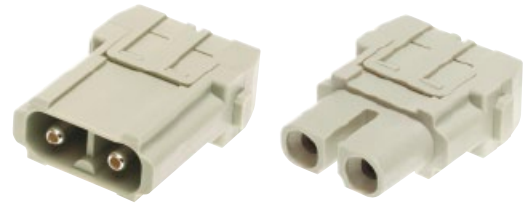

Identification	Part number		Drawing	Dimensions in mm
	Male insert (M)	Female insert (F)		
Axial screw terminal 40 A			<p>M</p> <p>F</p> <p>M F</p> <p>Contact arrangement view from termination side</p>	
2.5 ... 8 mm ²	09 14 002 2601	09 14 002 2701		
6 ... 10 mm ²	09 14 002 2602	09 14 002 2702		

Han
Modular

Identification	Part number	Drawing	Dimensions in mm
Hex key SW 2 for axial setscrew			
with grip	09 99 000 0313		
Bit 1/4"	09 99 000 0369		

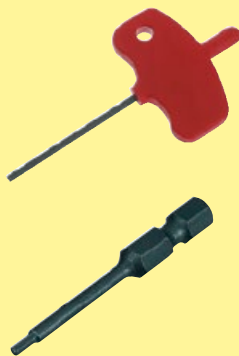

Features

- Crimp termination
- Compatible with Han® 40 A module with axial screw terminal

Technical characteristics

Specifications	DIN EN 60 664-1 DIN EN 61 984
----------------	----------------------------------

Inserts

Number of contacts	2
Electrical data acc. to EN 61 984	40 A 1000 V 8 kV 3
Rated current	40 A
Rated voltage	1000 V
Rated impulse voltage	8 kV
Pollution degree	3
Insulation resistance	$\geq 10^{10} \Omega$
Material	polycarbonate
Limiting temperatures	-40 °C ... +125 °C
Flammability acc. to UL 94	V 0
Mechanical working life - mating cycles	

Contacts

Material	copper alloy
Surface	
- hard-silver plated	3 μm Ag
Contact resistance	$\leq 0.3 \text{ m}\Omega$
Crimp terminal	
- mm^2	1.5 ... 10 mm^2
- AWG	16 ... 8

Current carrying capacity

The current carrying capacity of the connectors is limited by the thermal load capability of the contact element material including the connections and the insulating parts. The derating curve is therefore valid for currents which flow constantly (non-intermittent) through each contact element of the connector evenly, without exceeding the allowed maximum temperature.

Measuring and testing techniques according to DIN EN 60 512-5

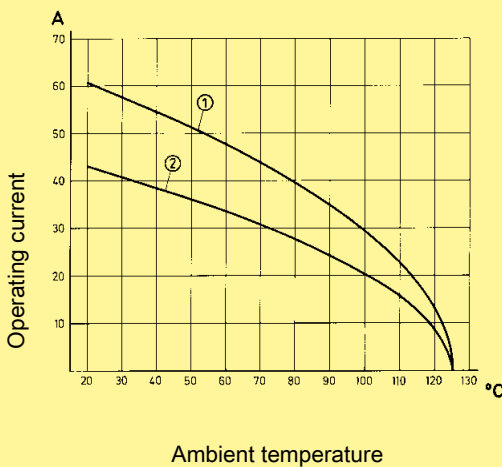

① 24 B hoods/housings with 6 modules; wire gauge: 10 mm^2

② 24 B hoods/housings with 6 modules; wire gauge: 6 mm^2

Number of contacts

2



Identification	Part number		Drawing	Dimensions in mm
	Male insert (M)	Female insert (F)		
Crimp terminal Order crimp contacts separately	09 14 002 3002	09 14 002 3102	<p>Contact arrangement view from termination side</p>	

Han Modular

Identification	Wire gauge (mm ²)	Part number		Drawing	Dimensions in mm																														
		Male contact	Female contact																																
Crimp contacts Power contacts silver plated 	1.5 2.5 4 6 10	09 32 000 6104 09 32 000 6105 09 32 000 6107 09 32 000 6108 09 32 000 6109	09 32 000 6204 09 32 000 6205 09 32 000 6207 09 32 000 6208 09 32 000 6209		<table border="1"> <thead> <tr> <th colspan="3">Wire gauge</th> <th>∅</th> <th>Stripping length</th> </tr> </thead> <tbody> <tr> <td>1.5</td> <td>mm²</td> <td>AWG 16</td> <td>1.75</td> <td>9 mm</td> </tr> <tr> <td>2.5</td> <td>mm²</td> <td>AWG 14</td> <td>2.25</td> <td>9 mm</td> </tr> <tr> <td>4</td> <td>mm²</td> <td>AWG 12</td> <td>2.85</td> <td>9.6 mm</td> </tr> <tr> <td>6</td> <td>mm²</td> <td>AWG 10</td> <td>3.5</td> <td>9.6 mm</td> </tr> <tr> <td>10</td> <td>mm²</td> <td>AWG 8</td> <td>4.3</td> <td>15 mm</td> </tr> </tbody> </table> <p>Stripping length a = 15 mm for cables ≥ 5 mm Stripping length a = 18 mm for cables ≥ 6.4 mm</p>	Wire gauge			∅	Stripping length	1.5	mm ²	AWG 16	1.75	9 mm	2.5	mm ²	AWG 14	2.25	9 mm	4	mm ²	AWG 12	2.85	9.6 mm	6	mm ²	AWG 10	3.5	9.6 mm	10	mm ²	AWG 8	4.3	15 mm
Wire gauge			∅	Stripping length																															
1.5	mm ²	AWG 16	1.75	9 mm																															
2.5	mm ²	AWG 14	2.25	9 mm																															
4	mm ²	AWG 12	2.85	9.6 mm																															
6	mm ²	AWG 10	3.5	9.6 mm																															
10	mm ²	AWG 8	4.3	15 mm																															

Features

- Axial screw terminal
- No special tools required for assembly
- Compatible to Han® C module with crimp terminal

Technical characteristics

Specifications DIN EN 60 664-1
DIN EN 61 984

Approvals

Inserts

Number of contacts 3
 Electrical data
 acc. to EN 61 984 **40 A 690 V 8 kV 3**
 Rated current 40 A
 Rated voltage 690 V
 Rated impulse voltage 8 kV
 Pollution degree 3

Rated voltage
 acc. to UL 600 V
 Insulation resistance ≥ 10¹⁰ Ω
 Material polycarbonate
 Limiting temperatures -40 °C ... +125 °C
 Flammability acc. to UL 94 V 0
 Mechanical working life
 - mating cycles ≥ 500

Contacts

Material copper alloy
 Surface
 - hard-silver plated 3 μm Ag
 Contact resistance 0.3 mΩ

Screw terminal
 - Wire gauge ¹⁾ 2.5 ... 10 mm²
 - AWG 14 ... 8
 - Hexagonal driver SW 2
 - Stripping length

mm ²	2.5	4	6	10
mm	5 ⁺¹	5 ⁺¹	8 ⁺¹	11 ⁺¹

- Tightening torque

mm ²	2.5	4	6	10
Nm	1.5	1.5	2	2

Current carrying capacity

The current carrying capacity of the connectors is limited by the thermal load capability of the contact element material including the connections and the insulating parts. The derating curve is therefore valid for currents which flow constantly (non-intermittent) through each contact element of the connector evenly, without exceeding the allowed maximum temperature.

Measuring and testing techniques according to DIN EN 60 512-5

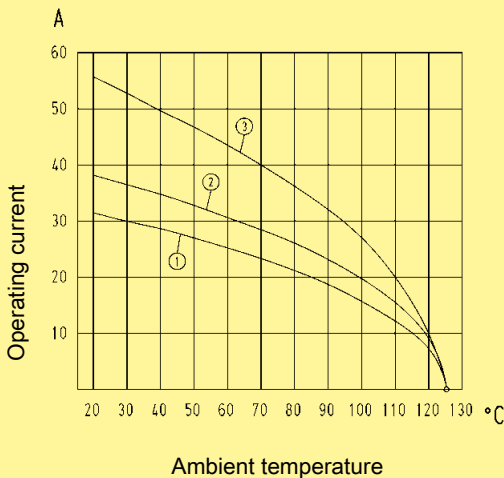

① 24 B hoods/housings with 6 modules; wire gauge: 4 mm²

② 24 B hoods/housings with 6 modules; wire gauge: 6 mm²

③ 24 B hoods/housings with 6 modules; wire gauge: 10 mm²

1) geometric wire gauge

Number of contacts

3

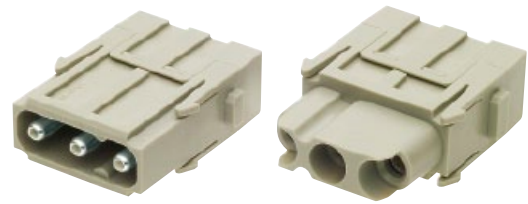

Identification	Part number		Drawing	Dimensions in mm
	Male insert (M)	Female insert (F)		
Axial screw terminal 40 A				
2.5 ... 8 mm ²	09 14 003 2601	09 14 003 2701		
6 ... 10 mm ²	09 14 003 2602	09 14 003 2702		

Han
Modular

Identification	Part number	Drawing	Dimensions in mm
Hex key SW 2 for axial setscrew			
with grip	09 99 000 0313		
Bit 1/4"	09 99 000 0369		



Features

- Suitable for Han® C crimp contacts
- Designed for a high working voltage up to 830 V
- Finger safe male and female contacts
- High contact density

Technical characteristics

Specifications DIN EN 60 664-1
DIN EN 61 984

Approvals

Inserts

Number of contacts	4
Electrical data acc. to EN 61 984	40 A 830 V 8 kV 3
Rated current	40 A
Rated voltage	830 V
Rated impulse voltage	8 kV
Pollution degree	3

Rated voltage acc. to UL	600 V
Insulation resistance	≥ 10 ¹⁰ Ω
Material	polycarbonate
Limiting temperatures	-40 °C ... +125 °C
Flammability acc. to UL 94	V 0
Mechanical working life - mating cycles	≥ 500

Contacts

Material	copper alloy
Surface	
- hard-silver plated	3 μm Ag
Contact resistance	≤ 0.3 mΩ
Crimp terminal	
- mm ²	1.5 ... 6 mm ²
- AWG	16 ... 10

Current carrying capacity

The current carrying capacity of the connectors is limited by the thermal load capability of the contact element material including the connections and the insulating parts. The derating curve is therefore valid for currents which flow constantly (non-intermittent) through each contact element of the connector evenly, without exceeding the allowed maximum temperature.

Measuring and testing techniques according to
DIN EN 60 512-5

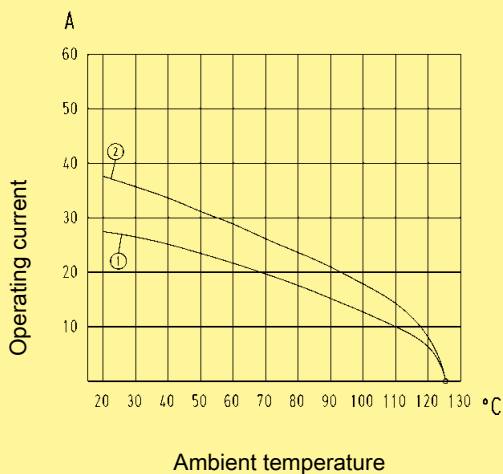

① 24 B hoods/housings with 6 modules; wire gauge: 4 mm²

② 24 B hoods/housings with 6 modules; wire gauge: 6 mm²

Number of contacts

4

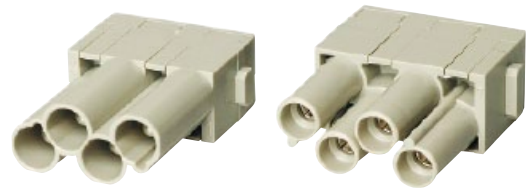

Identification	Part number		Drawing	Dimensions in mm
	Male insert (M)	Female insert (F)		
Crimp terminal Order crimp contacts separately	09 14 004 3041	09 14 004 3141	<p>Contact arrangement view from termination side</p>	

Han Modular

Identification	Wire gauge (mm ²)	Part number		Drawing	Dimensions in mm																				
		Male contact	Female contact																						
Crimp contacts Power contacts silver plated																									
	1.5 2.5 4 6	09 32 000 6104 09 32 000 6105 09 32 000 6107 09 32 000 6108	09 32 000 6204 09 32 000 6205 09 32 000 6207 09 32 000 6208	<table border="1"> <thead> <tr> <th colspan="2">Wire gauge</th> <th>∅</th> <th>Stripping length</th> </tr> </thead> <tbody> <tr> <td>1.5 mm²</td> <td>AWG 16</td> <td>1.75</td> <td>9 mm</td> </tr> <tr> <td>2.5 mm²</td> <td>AWG 14</td> <td>2.25</td> <td>9 mm</td> </tr> <tr> <td>4 mm²</td> <td>AWG 12</td> <td>2.85</td> <td>9.6 mm</td> </tr> <tr> <td>6 mm²</td> <td>AWG 10</td> <td>3.5</td> <td>9.6 mm</td> </tr> </tbody> </table>	Wire gauge		∅	Stripping length	1.5 mm ²	AWG 16	1.75	9 mm	2.5 mm ²	AWG 14	2.25	9 mm	4 mm ²	AWG 12	2.85	9.6 mm	6 mm ²	AWG 10	3.5	9.6 mm	
Wire gauge		∅	Stripping length																						
1.5 mm ²	AWG 16	1.75	9 mm																						
2.5 mm ²	AWG 14	2.25	9 mm																						
4 mm ²	AWG 12	2.85	9.6 mm																						
6 mm ²	AWG 10	3.5	9.6 mm																						

Features

- 3 contacts (40 A) for power circuits and 4 contacts (10 A) for signal circuits
- Ideal as motor drive connector
- Male and female contacts are finger safe

Technical characteristics

Specifications DIN EN 60 664-1
DIN EN 61 984

Approvals

Inserts

Number of contacts	3 / 4
Electrical data acc. to EN 61 984	
Power contacts	40 A 830 V 8 kV 3
Rated current	40 A
Rated voltage	830 V
Rated impulse voltage	8 kV
Pollution degree	3

Signal contacts	10 A 830 V 8 kV 3
Rated current	10 A
Rated voltage	830 V
Rated impulse voltage	8 kV
Pollution degree	3

Rated voltage acc. to UL	600 V
Insulation resistance	$\geq 10^{10} \Omega$
Material	polycarbonate
Limiting temperatures	-40 °C ... +125 °C
Flammability acc. to UL 94	V 0
Mechanical working life	
- mating cycles	≥ 500

Contacts

Material	copper alloy
Surface	
- hard-silver plated	3 μm Ag
- hard-gold plated	2 μm Au over 3 μm Ni
Contact resistance	
Power contacts	$\leq 0.3 \text{ m}\Omega$
Signal contacts	$\leq 3 \text{ m}\Omega$
Crimp terminal	
- mm^2	
Power contacts	1.5 ... 6 mm^2
Signal contacts	0.14 ... 2.5 mm^2
- AWG	
Power contacts	16 ... 10
Signal contacts	26 ... 14
Max. insulation diameter	
- Power contacts	5 mm

Current carrying capacity

The current carrying capacity of the connectors is limited by the thermal load capability of the contact element material including the connections and the insulating parts. The derating curve is therefore valid for currents which flow constantly (non-intermittent) through each contact element of the connector evenly, without exceeding the allowed maximum temperature.

Measuring and testing techniques according to DIN EN 60 512-5

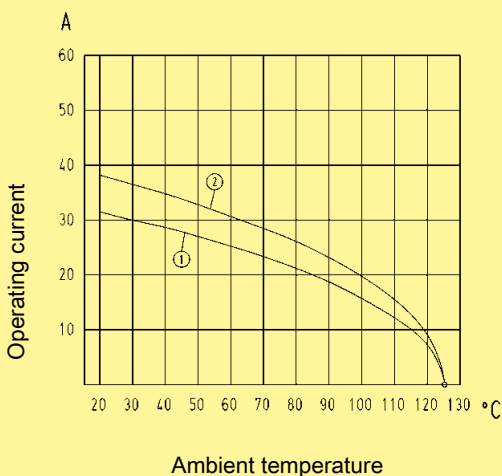

① 24 B hoods/housings with 6 modules; wire gauge: 4 mm^2

② 24 B hoods/housings with 6 modules; wire gauge: 6 mm^2

Number of contacts

3 / 4

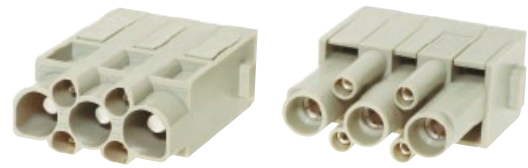

Identification	Part number		Drawing	Dimensions in mm
	Male insert (M)	Female insert (F)		
Crimp terminal Order crimp contacts separately	09 14 007 3001	09 14 007 3101		

Contact arrangement view from termination side

Han Modular

Identification	Wire gauge (mm ²)	Part number		Drawing	Dimensions in mm																												
		Male contact	Female contact																														
Crimp contacts Power contacts																																	
silver plated	1.5 2.5 4 6	09 32 000 6104 09 32 000 6105 09 32 000 6107 09 32 000 6108	09 32 000 6204 09 32 000 6205 09 32 000 6207 09 32 000 6208	<table border="1"> <thead> <tr> <th colspan="2">Wire gauge</th> <th>∅</th> <th>Stripping length</th> </tr> </thead> <tbody> <tr> <td>1.5 mm²</td> <td>AWG 16</td> <td>1.75</td> <td>9 mm</td> </tr> <tr> <td>2.5 mm²</td> <td>AWG 14</td> <td>2.25</td> <td>9 mm</td> </tr> <tr> <td>4 mm²</td> <td>AWG 12</td> <td>2.85</td> <td>9.6 mm</td> </tr> <tr> <td>6 mm²</td> <td>AWG 10</td> <td>3.5</td> <td>9.6 mm</td> </tr> </tbody> </table>	Wire gauge		∅	Stripping length	1.5 mm ²	AWG 16	1.75	9 mm	2.5 mm ²	AWG 14	2.25	9 mm	4 mm ²	AWG 12	2.85	9.6 mm	6 mm ²	AWG 10	3.5	9.6 mm									
Wire gauge		∅	Stripping length																														
1.5 mm ²	AWG 16	1.75	9 mm																														
2.5 mm ²	AWG 14	2.25	9 mm																														
4 mm ²	AWG 12	2.85	9.6 mm																														
6 mm ²	AWG 10	3.5	9.6 mm																														
Signal contacts silver plated	0.14-0.37 0.5 0.75 1 1.5 2.5	09 15 000 6104 09 15 000 6103 09 15 000 6105 09 15 000 6102 09 15 000 6101 09 15 000 6106	09 15 000 6204 09 15 000 6203 09 15 000 6205 09 15 000 6202 09 15 000 6201 09 15 000 6206																														
gold plated	0.14-0.37 0.5 0.75 1 1.5 2.5	09 15 000 6124 09 15 000 6123 09 15 000 6125 09 15 000 6122 09 15 000 6121 09 15 000 6126	09 15 000 6224 09 15 000 6223 09 15 000 6225 09 15 000 6222 09 15 000 6221 09 15 000 6226	<table border="1"> <thead> <tr> <th colspan="2">Wire gauge</th> <th>∅</th> <th>Stripping length</th> </tr> </thead> <tbody> <tr> <td>0.14-0.37 mm²</td> <td>AWG 26-22</td> <td>0.9</td> <td>8 mm</td> </tr> <tr> <td>0.5 mm²</td> <td>AWG 20</td> <td>1.1</td> <td>8 mm</td> </tr> <tr> <td>0.75 mm²</td> <td>AWG 18</td> <td>1.3</td> <td>8 mm</td> </tr> <tr> <td>1 mm²</td> <td>AWG 18</td> <td>1.45</td> <td>8 mm</td> </tr> <tr> <td>1.5 mm²</td> <td>AWG 16</td> <td>1.75</td> <td>8 mm</td> </tr> <tr> <td>2.5 mm²</td> <td>AWG 14</td> <td>2.25</td> <td>6 mm</td> </tr> </tbody> </table>	Wire gauge		∅	Stripping length	0.14-0.37 mm ²	AWG 26-22	0.9	8 mm	0.5 mm ²	AWG 20	1.1	8 mm	0.75 mm ²	AWG 18	1.3	8 mm	1 mm ²	AWG 18	1.45	8 mm	1.5 mm ²	AWG 16	1.75	8 mm	2.5 mm ²	AWG 14	2.25	6 mm	
Wire gauge		∅	Stripping length																														
0.14-0.37 mm ²	AWG 26-22	0.9	8 mm																														
0.5 mm ²	AWG 20	1.1	8 mm																														
0.75 mm ²	AWG 18	1.3	8 mm																														
1 mm ²	AWG 18	1.45	8 mm																														
1.5 mm ²	AWG 16	1.75	8 mm																														
2.5 mm ²	AWG 14	2.25	6 mm																														

Stock items in bold type

Features

- Suitable for Han E[®] crimp contacts
- Standard module for power up to 40 A

Technical characteristics

Specifications DIN EN 60 664-1
 DIN EN 61 984

Approvals

Inserts

Number of contacts 6
 Electrical data
 acc. to EN 61 984 **16 A 500 V 6 kV 3**
 Rated current 16 A
 Rated voltage 500 V
 Rated impulse voltage 6 kV
 Pollution degree 3

Rated voltage
 acc. to UL/CSA 600 V
 Insulation resistance $\geq 10^{10} \Omega$
 Material polycarbonate
 Limiting temperatures -40 °C ... +125 °C
 Flammability acc. to UL 94 V 0
 Mechanical working life
 - mating cycles ≥ 500

Contacts

Material copper alloy
 Surface
 - hard-silver plated 3 μm Ag
 - hard-gold plated 2 μm Au over 3 μm Ni
 Contact resistance $\leq 1 \text{ m}\Omega$
 Crimp terminal
 - mm^2 0.14 ... 4 mm^2
 - AWG 26 ... 12

Han
Modular

Current carrying capacity

The current carrying capacity of the connectors is limited by the thermal load capability of the contact element material including the connections and the insulating parts. The derating curve is therefore valid for currents which flow constantly (non-intermittent) through each contact element of the connector evenly, without exceeding the allowed maximum temperature.

Measuring and testing techniques according to
 DIN EN 60 512-5

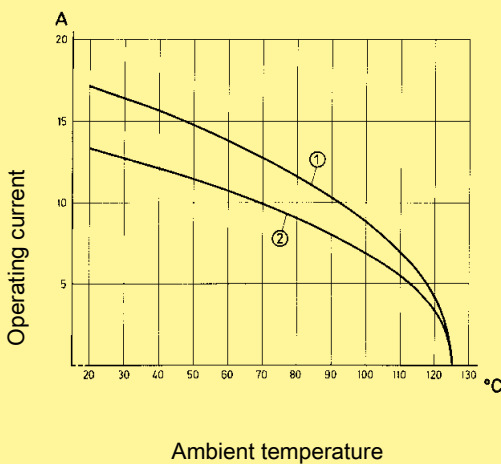

① 24 B hoods/housings with 6 modules; wire gauge: 2.5 mm²

② 24 B hoods/housings with 6 modules; wire gauge: 1.5 mm²

Number of contacts

6

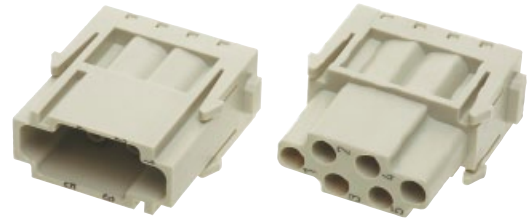

Identification	Part number		Drawing	Dimensions in mm
	Male insert (M)	Female insert (F)		
Crimp terminal Order crimp contacts separately	09 14 006 3001	09 14 006 3101	<p>Contact arrangement view from termination side</p>	

Han Modular

Identification	Wire gauge (mm²)	Part number		Drawing	Dimensions in mm
		Male contact	Female contact		
Crimp contacts Power contacts					
silver plated 	0,14-0,37	09 33 000 6127	09 33 000 6227		
	0,5	09 33 000 6121	09 33 000 6220		
	0,75	09 33 000 6114	09 33 000 6214		
	1	09 33 000 6105	09 33 000 6205		
	1,5	09 33 000 6104	09 33 000 6204		
	2,5	09 33 000 6102	09 33 000 6202		
	3	09 33 000 6106	09 33 000 6206		
	4	09 33 000 6107	09 33 000 6207		
gold plated 	0,14-0,37	09 33 000 6117	09 33 000 6217		
	0,5	09 33 000 6122	09 33 000 6222		
	0,75	09 33 000 6115	09 33 000 6215		
	1	09 33 000 6118	09 33 000 6218		
	1,5	09 33 000 6116	09 33 000 6216		
	2,5	09 33 000 6123	09 33 000 6223		
	4	09 33 000 6119	09 33 000 6221		
Relay contact silver plated 	0,75-1	09 33 000 6109			
	1,5	09 33 000 6110			
	2,5	09 33 000 6111			

Identification	Wire gauge	AWG	Stripping length
no groove	0.14-0.37 mm²	AWG 26-22	7.5 mm
no groove	0.5 mm²	AWG 20	7.5 mm
1 groove*	0.75 mm²	AWG 18	7.5 mm
1 groove	1 mm²	AWG 18	7.5 mm
2 grooves	1.5 mm²	AWG 16	7.5 mm
3 grooves	2.5 mm²	AWG 14	7.5 mm
wide groove	3 mm²	AWG 12	7.5 mm
no groove	4 mm²	AWG 12	7.5 mm

* on the back crimp collar

Crimp contacts 0.14 ... 0.37 mm² only used with BUCHANAN crimping tool 09 99 000 0001

Stock items in bold type

Features

- Suitable for Han E® crimp contacts
- High contact density
- Compatible to the Han® EE module with Quick Lock terminal

Technical characteristics

Specifications DIN EN 60 664-1
DIN EN 61 984

Approvals

Inserts

Number of contacts	8
Electrical data acc. to EN 61 984	16 A 400 V 6 kV 3
Rated current	16 A
Rated voltage	400 V
Rated impulse voltage	6 kV
Pollution degree	3

Rated voltage acc. to UL	600 V
Insulation resistance	≥ 10 ¹⁰ Ω
Material	polycarbonate
Limiting temperatures	-40 °C ... +125 °C
Flammability acc. to UL 94	V 0
Mechanical working life - mating cycles	≥ 500

Contacts

Material	copper alloy
Surface	
- hard-silver plated	3 μm Ag
- hard-gold plated	2 μm Au over 3 μm Ni
Contact resistance	≤ 1 mΩ
Crimp terminal	
- mm ²	0.14 ... 4 mm ²
- AWG	26 ... 12

Current carrying capacity

The current carrying capacity of the connectors is limited by the thermal load capability of the contact element material including the connections and the insulating parts. The derating curve is therefore valid for currents which flow constantly (non-intermittent) through each contact element of the connector evenly, without exceeding the allowed maximum temperature.

Measuring and testing techniques according to
DIN EN 60 512-5

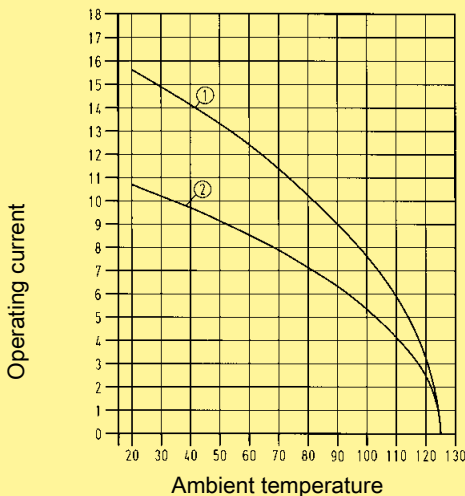

① 24 B hoods/housings with 6 modules; wire gauge: 2.5 mm²

② 24 B hoods/housings with 6 modules; wire gauge: 1.5 mm²

Number of contacts

8

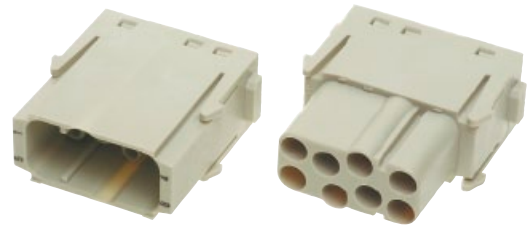

Identification	Part number		Drawing	Dimensions in mm
	Male insert (M)	Female insert (F)		
Crimp terminal Order crimp contacts separately	09 14 008 3001	09 14 008 3101	<p style="text-align: center;">Contact arrangement view from termination side</p>	

Han Modular

Identification	Wire gauge (mm ²)	Part number		Drawing	Dimensions in mm
		Male contact	Female contact		
Crimp contacts Power contacts					
silver plated 	0.14-0.37	09 33 000 6127	09 33 000 6227		
	0.5	09 33 000 6121	09 33 000 6220		
	0.75	09 33 000 6114	09 33 000 6214		
	1	09 33 000 6105	09 33 000 6205		
	1.5	09 33 000 6104	09 33 000 6204		
	2.5	09 33 000 6102	09 33 000 6202		
	3	09 33 000 6106	09 33 000 6206		
	4	09 33 000 6107	09 33 000 6207		
gold plated 	0.14-0.37	09 33 000 6117	09 33 000 6217		
	0.5	09 33 000 6122	09 33 000 6222		
	0.75	09 33 000 6115	09 33 000 6215		
	1	09 33 000 6118	09 33 000 6218		
	1.5	09 33 000 6116	09 33 000 6216		
	2.5	09 33 000 6123	09 33 000 6223		
	4	09 33 000 6119	09 33 000 6221		
Relay contact silver plated 	0.75-1	09 33 000 6109			
	1.5	09 33 000 6110			
	2.5	09 33 000 6111			

Identification	Wire gauge		Stripping length
no groove	0.14-0.37 mm ²	AWG 26-22	7.5 mm
no groove	0.5 mm ²	AWG 20	7.5 mm
1 groove*	0.75 mm ²	AWG 18	7.5 mm
1 groove	1 mm ²	AWG 18	7.5 mm
2 grooves	1.5 mm ²	AWG 16	7.5 mm
3 grooves	2.5 mm ²	AWG 14	7.5 mm
wide groove	3 mm ²	AWG 12	7.5 mm
no groove	4 mm ²	AWG 12	7.5 mm

* on the back crimp collar

Crimp contacts 0.14 ... 0.37 mm² only used with BUCHANAN crimping tool 09 99 000 0001

Stock items in bold type



Features

- Innovative Han-Quick Lock® termination technology
- Field assembly without special tools
- Compatible to Han® EE module with crimp terminal
- Reduced wiring times

Technical characteristics

Specifications	DIN EN 60 664-1 DIN EN 61 984
----------------	----------------------------------

Inserts

Number of contacts	8
Electrical data acc. to EN 61 984	16 A 400 V 6 kV 3
Rated current	16 A
Rated voltage	400 V
Rated impulse voltage	6 kV
Pollution degree	3
Insulation resistance	≥ 10 ¹⁰ Ω
Material	polycarbonate
Limiting temperatures	-40 °C ... +125 °C
Flammability acc. to UL 94	V 0
Mechanical working life - mating cycles	≥ 500

Contacts

Material	copper alloy
Surface	
- hard-silver plated	3 µm Ag
Contact resistance	≤ 1 mΩ
Quick Lock termination	
- mm ²	0.5 ... 2.5 mm ²
- AWG	20 ... 14

Current carrying capacity

The current carrying capacity of the connectors is limited by the thermal load capability of the contact element material including the connections and the insulating parts. The derating curve is therefore valid for currents which flow constantly (non-intermittent) through each contact element of the connector evenly, without exceeding the allowed maximum temperature.

Measuring and testing techniques according to DIN EN 60 512-5

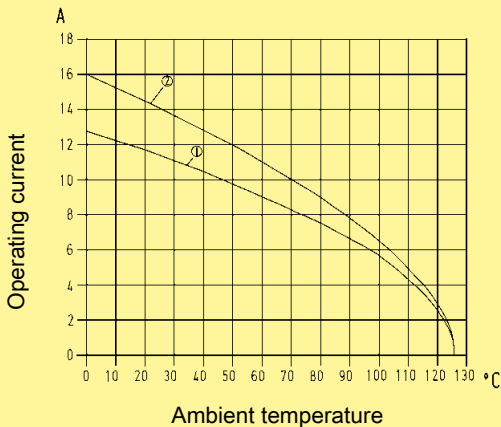



① 24 B hoods/housings with 6 modules; wire gauge: 1.5 mm²

② 24 B hoods/housings with 6 modules; wire gauge: 2.5 mm²

Number of contacts

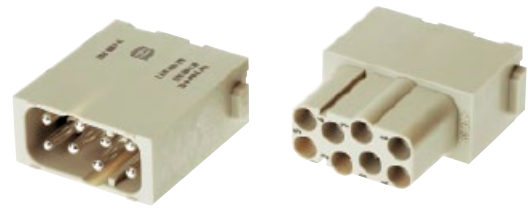
8

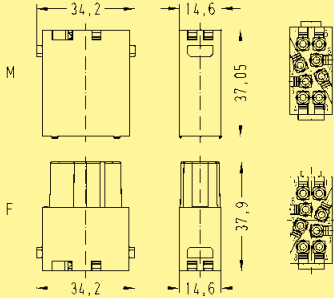

Identification	Part number		Drawing	Dimensions in mm
	Male insert (M)	Female insert (F)		
Quick Lock termination 	09 14 008 2633	09 14 008 2733	 <p> M F </p>	
			Contact arrangement view from termination side	

Han
Modular

Number of contacts

6



Identification	Part number		Drawing	Dimensions in mm
	Male insert (M)	Female insert (F)		
Crimp terminal Order crimp contacts separately	09 14 006 3041	09 14 006 3141	<p>M</p> <p>F</p> <p>M F</p> <p>Contact arrangement view from termination side</p>	

Han Modular

Identification	Wire gauge (mm²)	Part number		Drawing	Dimensions in mm
		Male contact	Female contact		
Crimp contacts Power contacts				<p>Operating contact Identification</p> <p>Relay contact</p>	
silver plated 	0.14-0.37	09 33 000 6127	09 33 000 6227		
	0.5	09 33 000 6121	09 33 000 6220		
	0.75	09 33 000 6114	09 33 000 6214		
	1	09 33 000 6105	09 33 000 6205		
	1.5	09 33 000 6104	09 33 000 6204		
	2.5	09 33 000 6102	09 33 000 6202		
	3	09 33 000 6106	09 33 000 6206		
	4	09 33 000 6107	09 33 000 6207		
gold plated 	0.14-0.37	09 33 000 6117	09 33 000 6217		
	0.5	09 33 000 6122	09 33 000 6222		
	0.75	09 33 000 6115	09 33 000 6215		
	1	09 33 000 6118	09 33 000 6218		
	1.5	09 33 000 6116	09 33 000 6216		
	2.5	09 33 000 6123	09 33 000 6223		
	4	09 33 000 6119	09 33 000 6221		
Relay contact silver plated 	0.75-1	09 33 000 6109			
	1.5	09 33 000 6110			
	2.5	09 33 000 6111			

Identification	Wire gauge		Stripping length
no groove	0.14-0.37 mm²	AWG 26-22	7.5 mm
no groove	0.5 mm²	AWG 20	7.5 mm
1 groove*	0.75 mm²	AWG 18	7.5 mm
1 groove	1 mm²	AWG 18	7.5 mm
2 grooves	1.5 mm²	AWG 16	7.5 mm
3 grooves	2.5 mm²	AWG 14	7.5 mm
wide groove	3 mm²	AWG 12	7.5 mm
no groove	4 mm²	AWG 12	7.5 mm

* on the back crimp collar

Crimp contacts 0.14 ... 0.37 mm² only used with BUCHANAN crimping tool 09 99 000 0001

Stock items in bold type

Features

- Suitable for Han E® crimp contacts
- High contact density
- Up to 16 A per contact
- Also suitable as a reliable signal connector

Technical characteristics

Specifications DIN EN 60 664-1
DIN EN 61 984

Approvals

Inserts

Number of contacts 20
Electrical data
acc. to EN 61 984 **16 A 500 V 6 kV 3**
Rated current 16 A
Rated voltage 500 V
Rated impulse voltage 6 kV
Pollution degree 3

Rated voltage
acc. to UL 600 V
Insulation resistance $\geq 10^{10} \Omega$
Material polycarbonate
Limiting temperatures -40 °C ... +125 °C
Flammability acc. to UL 94 V 0
Mechanical working life
- mating cycles ≥ 500

Contacts

Material copper alloy
Surface
- hard-silver plated 3 μm Ag
- hard-gold plated 2 μm Au over 3 μm Ni
Contact resistance $\leq 1 \text{ m}\Omega$
Crimp terminal
- mm² 0.14 ... 4 mm²
- AWG 26 ... 12

Current carrying capacity

The current carrying capacity of the connectors is limited by the thermal load capability of the contact element material including the connections and the insulating parts. The derating curve is therefore valid for currents which flow constantly (non-intermittent) through each contact element of the connector evenly, without exceeding the allowed maximum temperature.

Measuring and testing techniques according to DIN EN 60 512-5

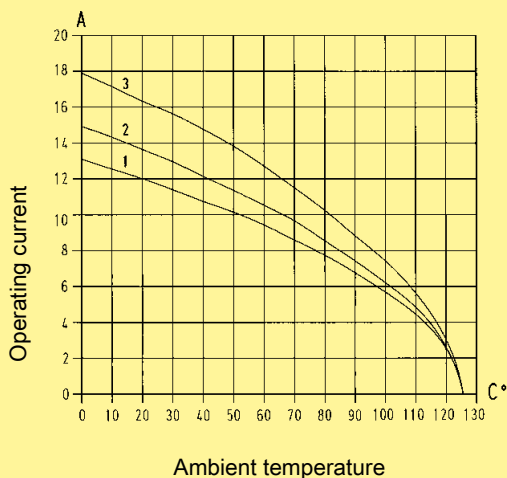

- ① 24 B hoods/housings with 3 modules; wire gauge: 1.5 mm²
- ② 24 B hoods/housings with 3 modules; wire gauge: 2.5 mm²
- ③ 24 B hoods/housings with 3 modules; wire gauge: 4 mm²

Number of contacts

20



Identification	Part number		Drawing	Dimensions in mm
	Male insert (M)	Female insert (F)		
Crimp terminal Order crimp contacts separately	09 14 020 3001	09 14 020 3101	<p>Contact arrangement view from termination side</p>	

Han Modular

Identification	Wire gauge (mm ²)	Part number		Drawing	Dimensions in mm
		Male contact	Female contact		
Crimp contacts Power contacts					
silver plated 	0.14-0.37	09 33 000 6127	09 33 000 6227		
	0.5	09 33 000 6121	09 33 000 6220		
	0.75	09 33 000 6114	09 33 000 6214		
	1	09 33 000 6105	09 33 000 6205		
	1.5	09 33 000 6104	09 33 000 6204		
	2.5	09 33 000 6102	09 33 000 6202		
	3	09 33 000 6106	09 33 000 6206		
	4	09 33 000 6107	09 33 000 6207		
gold plated 	0.14-0.37	09 33 000 6117	09 33 000 6217		
	0.5	09 33 000 6122	09 33 000 6222		
	0.75	09 33 000 6115	09 33 000 6215		
	1	09 33 000 6118	09 33 000 6218		
	1.5	09 33 000 6116	09 33 000 6216		
	2.5	09 33 000 6123	09 33 000 6223		
	4	09 33 000 6119	09 33 000 6221		
Relay contact silver plated 	0.75-1	09 33 000 6109			
	1.5	09 33 000 6110			
	2.5	09 33 000 6111			

Identification	Wire gauge		Stripping length
no groove	0.14-0.37 mm ²	AWG 26-22	7.5 mm
no groove	0.5 mm ²	AWG 20	7.5 mm
1 groove*	0.75 mm ²	AWG 18	7.5 mm
1 groove	1 mm ²	AWG 18	7.5 mm
2 grooves	1.5 mm ²	AWG 16	7.5 mm
3 grooves	2.5 mm ²	AWG 14	7.5 mm
wide groove	3 mm ²	AWG 12	7.5 mm
no groove	4 mm ²	AWG 12	7.5 mm

* on the back crimp collar

Crimp contacts 0.14 ... 0.37 mm² only used with BUCHANAN crimping tool 09 99 000 0001

Stock items in bold type

Features

- Cage-clamp terminal
- No special tools required

Technical characteristics

Specifications DIN EN 60 664-1
DIN EN 61 984

Approvals

Inserts

Number of contacts	5
Electrical data acc. to EN 61 984	16 A 400 V 6 kV 3
Rated current	16 A
Rated voltage	400 V
Rated impulse voltage	6 kV
Pollution degree	3

Rated voltage acc. to UL	600 V
Insulation resistance	≥ 10 ¹⁰ Ω
Material	polycarbonate
Limiting temperatures	-40 °C ... +125 °C
Flammability acc. to UL 94	V 0
Mechanical working life - mating cycles	≥ 500

Contacts

Material	copper alloy
Surface	
- hard-silver plated	3 μm Ag
Contact resistance	≤ 3 mΩ
Cage clamp terminal	
- mm ²	0.14 ... 2.5 mm ²
- AWG	26 ... 14

Current carrying capacity

The current carrying capacity of the connectors is limited by the thermal load capability of the contact element material including the connections and the insulating parts. The derating curve is therefore valid for currents which flow constantly (non-intermittent) through each contact element of the connector evenly, without exceeding the allowed maximum temperature.

Measuring and testing techniques according to DIN EN 60 512-5

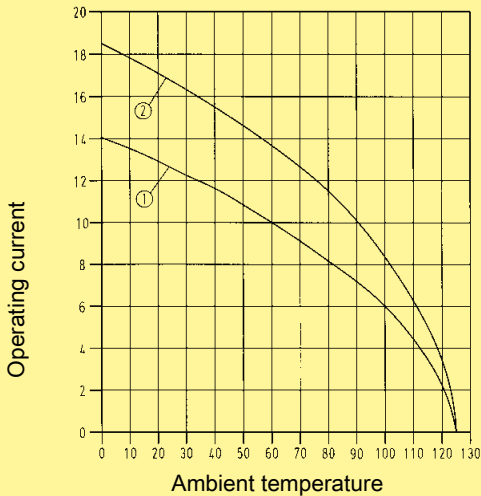

① 24 B hoods/housings with 6 modules; wire gauge: 2.5 mm²

② 24 B hoods/housings with 6 modules; wire gauge: 1.5 mm²

Number of contacts

5

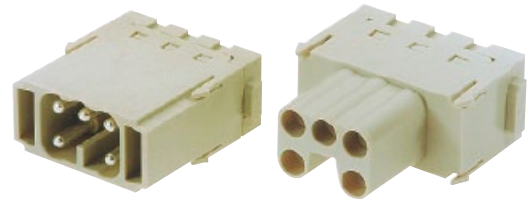

Identification	Part number		Drawing	Dimensions in mm
	Male insert (M)	Female insert (F)		
Cage-clamp terminal	09 14 005 2616	09 14 005 2716	<p>M</p> <p>F</p> <p>M F</p> <p>Contact arrangement view from termination side</p>	

Han
Modular

Features

- Suitable for Han E® crimp contacts
- 2 contacts up to 5000 V
- Insulator out of a voltage resistant teflon material
- Combination of all other modules (pneumatic, signal etc.)

Technical characteristics

Specifications	DIN EN 61 984 DIN VDE 0115 DIN EN 60 664-1
----------------	--

Approvals	
-----------	--

Inserts

Number of contacts	2
Electrical data acc. to EN 61 984	16 A 2900/5000 V 15 kV 3
Rated current	16 A
Rated voltage conductor - ground	2900 V
Rated voltage conductor - conductor	5000 V
Rated impulse voltage	15 kV
Pollution degree	3

Insulation resistance	≥ 10 ¹⁰ Ω
Material	polycarbonate/Teflon (PTFE)
Limiting temperatures	-40 °C ... +125 °C
Flammability acc. to UL 94	V 0
Mechanical working life - mating cycles	≥ 500

Contacts

Material	copper alloy
Surface	
- hard-silver plated	3 μm Ag
- hard-gold plated	2 μm Au over 3 μm Ni
Contact resistance	≤ 1 mΩ
Crimp terminal	
- mm ²	0.5 ... 4 mm ²
- AWG	20 ... 12

Current carrying capacity

The current carrying capacity of the connectors is limited by the thermal load capability of the contact element material including the connections and the insulating parts. The derating curve is therefore valid for currents which flow constantly (non-intermittent) through each contact element of the connector evenly, without exceeding the allowed maximum temperature.

Measuring and testing techniques according to DIN EN 60 512-5

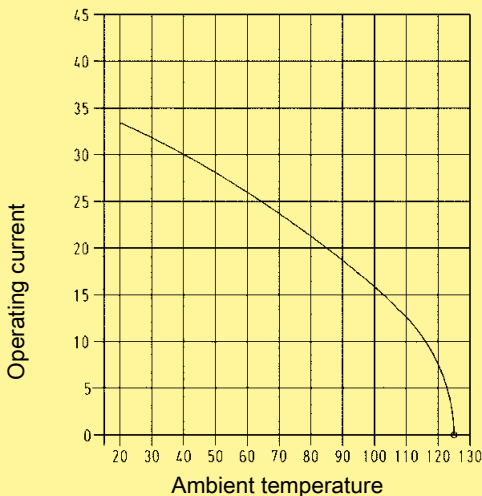

① Housing Han® 16 B with 1 Han® HV module, wire gauge: 2.5 mm²

Assembly instructions

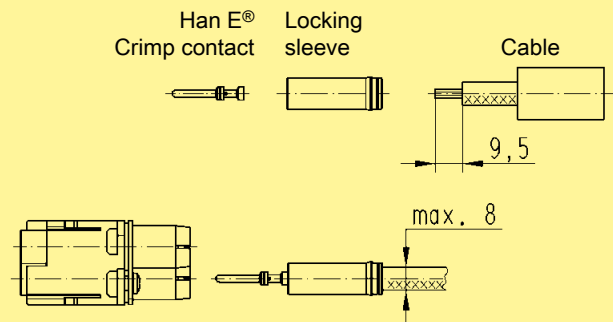

Crimp with BUCHANAN crimping tool 09 99 000 0001
Snap crimped cable in the insert

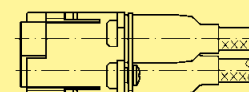

shrink the heat shrink tube over the rear of contact

Number of contacts

2

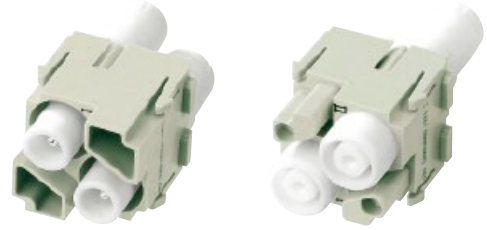

Identification	Part number		Drawing	Dimensions in mm
	Male insert (M)	Female insert (F)		
<p>Crimp terminal</p> <p>Order crimp contacts separately</p> <p>Range of delivery:</p> <ul style="list-style-type: none"> - 1 module - 2 locking sleeves - 2 heat shrink tubes <p>Removal tool for locking sleeve</p>	<p>09 14 002 3021</p>	<p>09 14 002 3121</p>	<p>M</p> <p>F</p> 	
	<p>09 99 000 0327</p>	<p>09 99 000 0327</p>		

Han Modular

Identification	Wire gauge (mm²)	Part number		Drawing	Dimensions in mm																															
		Male contact	Female contact																																	
<p>Crimp contacts</p> <p>silver plated</p>	<p>0.5</p> <p>0.75</p> <p>1</p> <p>1.5</p> <p>2.5</p> <p>3</p> <p>4</p>	<p>09 33 000 6121</p> <p>09 33 000 6114</p> <p>09 33 000 6105</p> <p>09 33 000 6104</p> <p>09 33 000 6102</p> <p>09 33 000 6106</p> <p>09 33 000 6107</p>	<p>09 33 000 6220</p> <p>09 33 000 6214</p> <p>09 33 000 6205</p> <p>09 33 000 6204</p> <p>09 33 000 6202</p> <p>09 33 000 6206</p> <p>09 33 000 6207</p>	<p>Operating contact Identification</p>	<table border="1"> <thead> <tr> <th>Identification</th> <th>Wire gauge</th> <th>Stripping length</th> </tr> </thead> <tbody> <tr> <td>no groove</td> <td>0.5 mm²</td> <td>AWG 20</td> <td>9.5 mm</td> </tr> <tr> <td>1 groove*</td> <td>0.75 mm²</td> <td>AWG 18</td> <td>9.5 mm</td> </tr> <tr> <td>1 groove</td> <td>1 mm²</td> <td>AWG 18</td> <td>9.5 mm</td> </tr> <tr> <td>2 grooves</td> <td>1.5 mm²</td> <td>AWG 16</td> <td>9.5 mm</td> </tr> <tr> <td>3 grooves</td> <td>2.5 mm²</td> <td>AWG 14</td> <td>9.5 mm</td> </tr> <tr> <td>wide groove</td> <td>3 mm²</td> <td>AWG 12</td> <td>9.5 mm</td> </tr> <tr> <td>no groove</td> <td>4 mm²</td> <td>AWG 12</td> <td>9.5 mm</td> </tr> </tbody> </table> <p>* on the back crimp collar</p>	Identification	Wire gauge	Stripping length	no groove	0.5 mm²	AWG 20	9.5 mm	1 groove*	0.75 mm²	AWG 18	9.5 mm	1 groove	1 mm²	AWG 18	9.5 mm	2 grooves	1.5 mm²	AWG 16	9.5 mm	3 grooves	2.5 mm²	AWG 14	9.5 mm	wide groove	3 mm²	AWG 12	9.5 mm	no groove	4 mm²	AWG 12	9.5 mm
Identification	Wire gauge	Stripping length																																		
no groove	0.5 mm²	AWG 20	9.5 mm																																	
1 groove*	0.75 mm²	AWG 18	9.5 mm																																	
1 groove	1 mm²	AWG 18	9.5 mm																																	
2 grooves	1.5 mm²	AWG 16	9.5 mm																																	
3 grooves	2.5 mm²	AWG 14	9.5 mm																																	
wide groove	3 mm²	AWG 12	9.5 mm																																	
no groove	4 mm²	AWG 12	9.5 mm																																	

Features

- Suitable for Han® C crimp contacts
- 2 contacts up to 5000 V
- Insulator out of a voltage resistant teflon material
- Combination of all other modules (pneumatic, signal etc.)

Technical characteristics

Specifications	DIN EN 61 984 DIN VDE 0115 DIN EN 60 664-1
----------------	--

Inserts

Number of contacts	2
Electrical data acc. to EN 61 984	40 A 2900/5000 V 15 kV 3
Rated current	40 A
Rated voltage conductor - ground	2900 V
Rated voltage conductor - conductor	5000 V
Rated impulse voltage	15 kV
Pollution degree	3

Insulation resistance	≥ 10 ¹⁰ Ω
Material	polycarbonate/Teflon (PTFE)
Limiting temperatures	-40 °C ... +125 °C
Flammability acc. to UL 94	V 0
Max. cable diameter	9 mm
Mechanical working life - mating cycles	≥ 500

Contacts

Material	copper alloy
Surface	
- hard-silver plated	3 μm Ag
Contact resistance	≤ 0.3 mΩ
Crimp terminal	
- mm ²	1.5 ... 10 mm ²
- AWG	16 ... 8

Assembly instructions

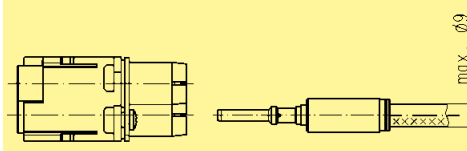
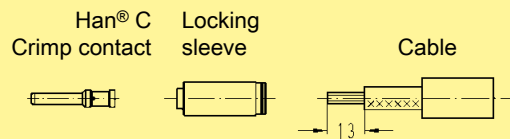

Crimp with tool 0999 000 0001,
0999 000 0110 or 0999 000 0377
Snap crimped cable in the insert

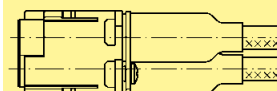

shrink the heat shrink tube over the
rear of contact

Number of contacts

2

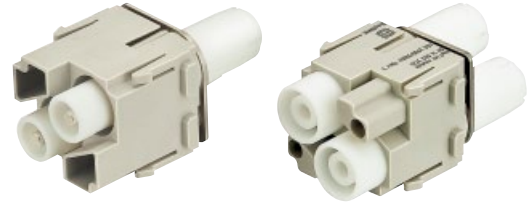

Identification	Part number		Drawing	Dimensions in mm
	Male insert (M)	Female insert (F)		
<p>Crimp terminal</p> <p>Order crimp contacts separately</p> <p>Range of delivery:</p> <ul style="list-style-type: none"> - 1 module - 2 locking sleeves - 2 heat shrink tubes <p>Removal tool for locking sleeve</p>	<p>09 14 002 3023</p>	<p>09 14 002 3123</p>	<p>M</p> <p>F</p>	
	<p>09 99 000 0327</p>	<p>09 99 000 0327</p>		

Han Modular

Identification	Wire gauge (mm ²)	Part number		Drawing	Dimensions in mm																														
		Male contact	Female contact																																
<p>Crimp contacts</p> <p>Power contacts</p> <p>silver plated</p>	<p>1.5</p> <p>2.5</p> <p>4</p> <p>6</p> <p>10</p>	<p>09 32 000 6104</p> <p>09 32 000 6105</p> <p>09 32 000 6107</p> <p>09 32 000 6108</p> <p>09 32 000 6109</p>	<p>09 32 000 6204</p> <p>09 32 000 6205</p> <p>09 32 000 6207</p> <p>09 32 000 6208</p> <p>09 32 000 6209</p>																																
				<table border="1"> <thead> <tr> <th colspan="3">Wire gauge</th> <th>∅</th> <th>Stripping length</th> </tr> </thead> <tbody> <tr> <td>1.5</td> <td>mm²</td> <td>AWG 16</td> <td>1.75</td> <td>13 mm</td> </tr> <tr> <td>2.5</td> <td>mm²</td> <td>AWG 14</td> <td>2.25</td> <td>13 mm</td> </tr> <tr> <td>4</td> <td>mm²</td> <td>AWG 12</td> <td>2.85</td> <td>13 mm</td> </tr> <tr> <td>6</td> <td>mm²</td> <td>AWG 10</td> <td>3.5</td> <td>13 mm</td> </tr> <tr> <td>10</td> <td>mm²</td> <td>AWG 8</td> <td>4.3</td> <td>13 mm</td> </tr> </tbody> </table>	Wire gauge			∅	Stripping length	1.5	mm ²	AWG 16	1.75	13 mm	2.5	mm ²	AWG 14	2.25	13 mm	4	mm ²	AWG 12	2.85	13 mm	6	mm ²	AWG 10	3.5	13 mm	10	mm ²	AWG 8	4.3	13 mm	
Wire gauge			∅	Stripping length																															
1.5	mm ²	AWG 16	1.75	13 mm																															
2.5	mm ²	AWG 14	2.25	13 mm																															
4	mm ²	AWG 12	2.85	13 mm																															
6	mm ²	AWG 10	3.5	13 mm																															
10	mm ²	AWG 8	4.3	13 mm																															

Features

- Suitable for Han D[®] crimp contacts
- Standard module for power up to 10 A

Technical characteristics

Specifications DIN EN 60 664-1
 DIN EN 61 984

Approvals

Inserts

Number of contacts 12
 Electrical data
 acc. to EN 61 984 **10 A 250 V 4 kV 3**
 Rated current 10 A
 Rated voltage 250 V
 Rated impulse voltage 4 kV
 Pollution degree 3

Rated voltage
 acc. to UL/CSA 600 V
 Insulation resistance $\geq 10^{10} \Omega$
 Material polycarbonate
 Limiting temperatures -40 °C ... +125 °C
 Flammability acc. to UL 94 V 0
 Mechanical working life
 - mating cycles ≥ 500

Contacts

Material copper alloy
 Surface
 - hard-silver plated 3 μm Ag
 - hard-gold plated 2 μm Au over 3 μm Ni
 Contact resistance $\leq 3 \text{ m}\Omega$
 Crimp terminal
 - mm^2 0.14 ... 2.5 mm^2
 - AWG 26 ... 14

Current carrying capacity

The current carrying capacity of the connectors is limited by the thermal load capability of the contact element material including the connections and the insulating parts. The derating curve is therefore valid for currents which flow constantly (non-intermittent) through each contact element of the connector evenly, without exceeding the allowed maximum temperature.

Measuring and testing techniques according to DIN EN 60 512-5

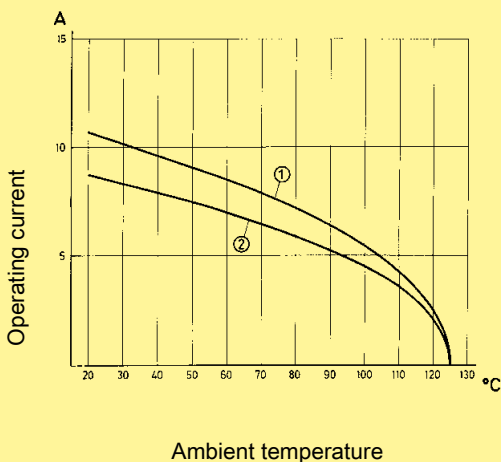

① 24 B hoods/housings with 6 modules; wire gauge: 1.5 mm^2

② 24 B hoods/housings with 6 modules; wire gauge: 1.0 mm^2

Number of contacts

12

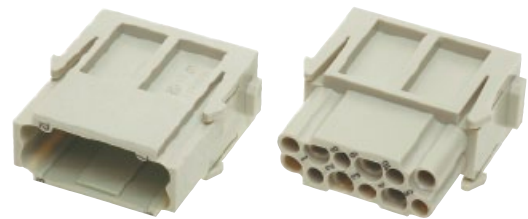

Identification	Part number		Drawing	Dimensions in mm
	Male insert (M)	Female insert (F)		
Crimp terminal Order crimp contacts separately	09 14 012 3001	09 14 012 3101	<p>M</p> <p>F</p> <p>M</p> <p>F</p> <p>Contact arrangement view from termination side</p>	

Han Modular

Identification	Wire gauge (mm ²)	Part number		Drawing	Dimensions in mm																												
		Male contact	Female contact																														
Crimp contacts Power contacts silver plated 	0.14-0.37 0.5 0.75 1 1.5 2.5	09 15 000 6104 09 15 000 6103 09 15 000 6105 09 15 000 6102 09 15 000 6101 09 15 000 6106	09 15 000 6204 09 15 000 6203 09 15 000 6205 09 15 000 6202 09 15 000 6201 09 15 000 6206																														
gold plated 	0.14-0.37 0.5 0.75 1 1.5 2.5	09 15 000 6124 09 15 000 6123 09 15 000 6125 09 15 000 6122 09 15 000 6121 09 15 000 6126	09 15 000 6224 09 15 000 6223 09 15 000 6225 09 15 000 6222 09 15 000 6221 09 15 000 6226	<table border="1"> <thead> <tr> <th colspan="2">Wire gauge</th> <th>∅</th> <th>Stripping length</th> </tr> </thead> <tbody> <tr> <td>0.14-0.37 mm²</td> <td>AWG 26-22</td> <td>0.9</td> <td>8 mm</td> </tr> <tr> <td>0.5 mm²</td> <td>AWG 20</td> <td>1.1</td> <td>8 mm</td> </tr> <tr> <td>0.75 mm²</td> <td>AWG 18</td> <td>1.3</td> <td>8 mm</td> </tr> <tr> <td>1 mm²</td> <td>AWG 18</td> <td>1.45</td> <td>8 mm</td> </tr> <tr> <td>1.5 mm²</td> <td>AWG 16</td> <td>1.75</td> <td>8 mm</td> </tr> <tr> <td>2.5 mm²</td> <td>AWG 14</td> <td>2.25</td> <td>6 mm</td> </tr> </tbody> </table>	Wire gauge		∅	Stripping length	0.14-0.37 mm ²	AWG 26-22	0.9	8 mm	0.5 mm ²	AWG 20	1.1	8 mm	0.75 mm ²	AWG 18	1.3	8 mm	1 mm ²	AWG 18	1.45	8 mm	1.5 mm ²	AWG 16	1.75	8 mm	2.5 mm ²	AWG 14	2.25	6 mm	
Wire gauge		∅	Stripping length																														
0.14-0.37 mm ²	AWG 26-22	0.9	8 mm																														
0.5 mm ²	AWG 20	1.1	8 mm																														
0.75 mm ²	AWG 18	1.3	8 mm																														
1 mm ²	AWG 18	1.45	8 mm																														
1.5 mm ²	AWG 16	1.75	8 mm																														
2.5 mm ²	AWG 14	2.25	6 mm																														
F.O. contacts for 1 mm plastic fibre 		20 10 001 3211	20 10 001 3221																														

Stock items in bold type



Features

- Innovative Han-Quick Lock[®] termination technology
- Field assembly without special tools
- Mating compatible with standard Han[®] DD module with crimp terminal
- Reduced wiring times

Technical characteristics

Specifications	DIN EN 60 664-1 DIN EN 61 984
----------------	----------------------------------

Inserts

Number of contacts	12
Electrical data acc. to EN 61 984	10 A 250 V 4 kV 3
Rated current	10 A
Rated voltage	250 V
Rated impulse voltage	4 kV
Pollution degree	3

Insulation resistance	$\geq 10^{10} \Omega$
Material	polycarbonate
Limiting temperatures	-40 °C ... +125 °C
Flammability acc. to UL 94	V 0
Mechanical working life - mating cycles	

Contacts

Material	copper alloy
Surface	
- hard-silver plated	3 μm Ag
Contact resistance	$\leq 3 \text{ m}\Omega$
Quick Lock termination	
- mm ²	0.25 ... 1.5 mm ²
- AWG	22 ... 16

Current carrying capacity

The current carrying capacity of the connectors is limited by the thermal load capability of the contact element material including the connections and the insulating parts. The derating curve is therefore valid for currents which flow constantly (non-intermittent) through each contact element of the connector evenly, without exceeding the allowed maximum temperature.

Measuring and testing techniques according to
DIN EN 60 512-5

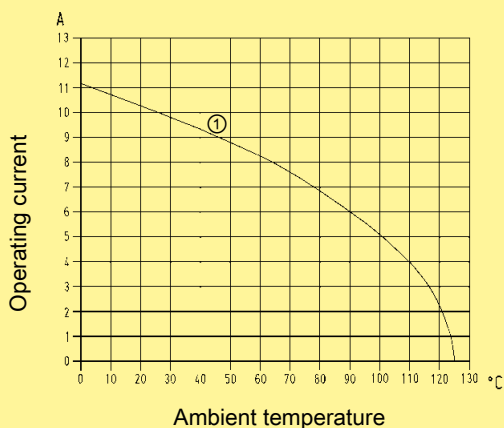

① 24 B hoods/housings with 6 modules; wire gauge: 1.5 mm²



Number of contacts

12

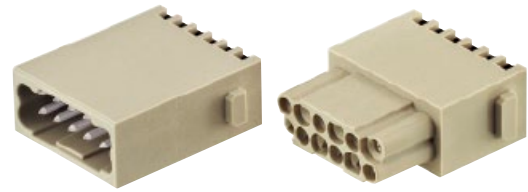

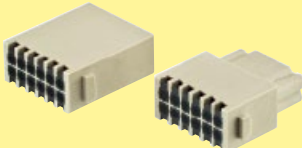
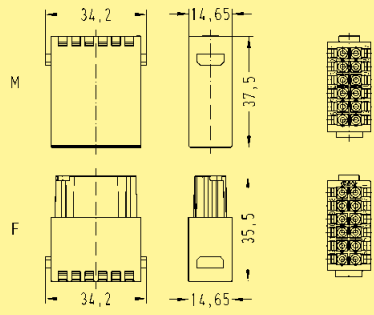
Identification	Part number		Drawing	Dimensions in mm
	Male insert (M)	Female insert (F)		
Quick Lock termination 	09 14 012 2632	09 14 012 2732	 <p style="text-align: center;">Contact arrangement view from termination side</p>	

Han Modular

06
61

Stock items in bold type

Features

- Suitable for Han D® crimp contacts
- High contact density

Technical characteristics

Specifications DIN EN 60 664-1
DIN EN 61 984

Approvals

Inserts

Number of contacts	17
Electrical data acc. to EN 61 984	10 A 160 V 2.5 kV 3
Rated current	10 A
Rated voltage	160 V
Rated impulse voltage	2.5 kV
Pollution degree	3

Rated voltage acc. to UL	250 V
Insulation resistance	≥ 10 ¹⁰ Ω
Material	polycarbonate
Limiting temperatures	-40 °C ... +125 °C
Flammability acc. to UL 94	V 0
Mechanical working life - mating cycles	≥ 500

Contacts

Material	copper alloy
Surface	
- hard-silver plated	3 μm Ag
- hard-gold plated	2 μm Au over 3 μm Ni
Contact resistance	≤ 3 mΩ
Crimp terminal	
- mm ²	0.14 ... 2.5 mm ²
- AWG	26 ... 14

Han
Modular

Current carrying capacity

The current carrying capacity of the connectors is limited by the thermal load capability of the contact element material including the connections and the insulating parts. The derating curve is therefore valid for currents which flow constantly (non-intermittent) through each contact element of the connector evenly, without exceeding the allowed maximum temperature.

Measuring and testing techniques according to
DIN EN 60 512-5

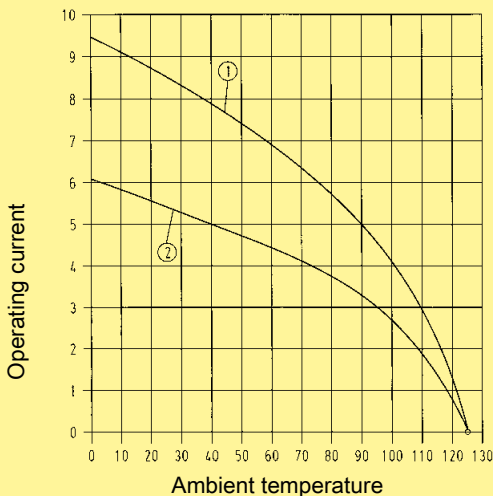

① 24 B hoods/housings with 6 modules; wire gauge: 1.5 mm²

② 24 B hoods/housings with 6 modules; wire gauge: 1.0 mm²

Number of contacts

17

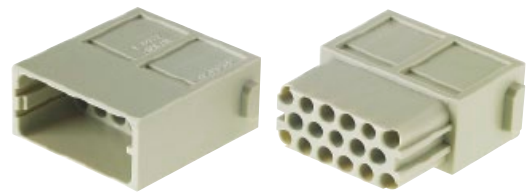

Identification	Part number		Drawing	Dimensions in mm
	Male insert (M)	Female insert (F)		
Crimp terminal Order crimp contacts separately	09 14 017 3001	09 14 017 3101	<p>Contact arrangement view from termination side</p>	

Han Modular

Identification	Wire gauge (mm ²)	Part number		Drawing	Dimensions in mm																												
		Male contact	Female contact																														
Crimp contacts Power contacts silver plated 	0.14-0.37 0.5 0.75 1 1.5 2.5	09 15 000 6104 09 15 000 6103 09 15 000 6105 09 15 000 6102 09 15 000 6101 09 15 000 6106	09 15 000 6204 09 15 000 6203 09 15 000 6205 09 15 000 6202 09 15 000 6201 09 15 000 6206	<table border="1"> <thead> <tr> <th colspan="2">Wire gauge</th> <th>∅</th> <th>Stripping length</th> </tr> </thead> <tbody> <tr> <td>0.14-0.37 mm²</td> <td>AWG 26-22</td> <td>0.9</td> <td>8 mm</td> </tr> <tr> <td>0.5 mm²</td> <td>AWG 20</td> <td>1.1</td> <td>8 mm</td> </tr> <tr> <td>0.75 mm²</td> <td>AWG 18</td> <td>1.3</td> <td>8 mm</td> </tr> <tr> <td>1 mm²</td> <td>AWG 18</td> <td>1.45</td> <td>8 mm</td> </tr> <tr> <td>1.5 mm²</td> <td>AWG 16</td> <td>1.75</td> <td>8 mm</td> </tr> <tr> <td>2.5 mm²</td> <td>AWG 14</td> <td>2.25</td> <td>6 mm</td> </tr> </tbody> </table>	Wire gauge		∅	Stripping length	0.14-0.37 mm ²	AWG 26-22	0.9	8 mm	0.5 mm ²	AWG 20	1.1	8 mm	0.75 mm ²	AWG 18	1.3	8 mm	1 mm ²	AWG 18	1.45	8 mm	1.5 mm ²	AWG 16	1.75	8 mm	2.5 mm ²	AWG 14	2.25	6 mm	
Wire gauge		∅	Stripping length																														
0.14-0.37 mm ²	AWG 26-22	0.9	8 mm																														
0.5 mm ²	AWG 20	1.1	8 mm																														
0.75 mm ²	AWG 18	1.3	8 mm																														
1 mm ²	AWG 18	1.45	8 mm																														
1.5 mm ²	AWG 16	1.75	8 mm																														
2.5 mm ²	AWG 14	2.25	6 mm																														
F.O. contacts for 1 mm plastic fibre 		20 10 001 3211	20 10 001 3221																														

Stock items in bold type

Features

- Suitable for D-Sub crimp contacts
- High contact density
- Using of guiding pins (male and female) is recommended (see chapter 40).

Technical characteristics

Specifications	DIN EN 60 664-1 DIN EN 61 984
----------------	----------------------------------

Inserts

Number of contacts	25
Electrical data acc. to EN 61 984	4 A 50 V 0.8 kV 3
Rated current	4 A
Rated voltage	50 V
Rated impulse voltage	0.8 kV
Pollution degree	3

Insulation resistance	≥ 10 ¹⁰ Ω
Material	polycarbonate
Limiting temperatures	-40 °C ... +125 °C
Flammability acc. to UL 94	V 0
Mechanical working life - mating cycles	≥ 500

Contacts

Crimp terminal	
- mm ²	0.08 ... 0.52 mm ²
- AWG	28 ... 20
turned contacts	Performance level 1 as per CECC 75 301-802, 500 mating cycles, 10 days 4 mixed gas test - IEC 60 512

Current carrying capacity

The current carrying capacity of the connectors is limited by the thermal load capability of the contact element material including the connections and the insulating parts. The derating curve is therefore valid for currents which flow constantly (non-intermittent) through each contact element of the connector evenly, without exceeding the allowed maximum temperature.

Measuring and testing techniques according to
DIN EN 60 512-5

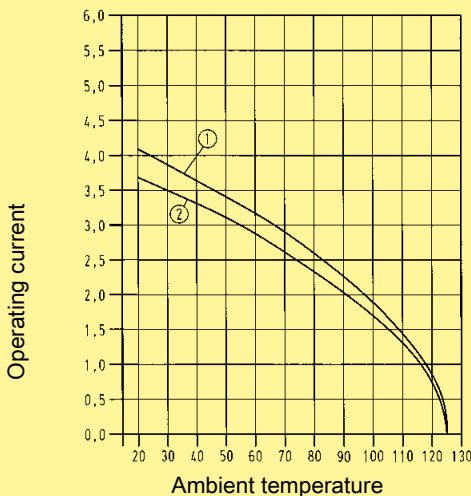

① 24 B hoods/housings with 6 modules; wire gauge: 0.5 mm² turned contacts

② 24 B hoods/housings with 6 modules; wire gauge: 0.5 mm² stamped contacts

Number of contacts

25

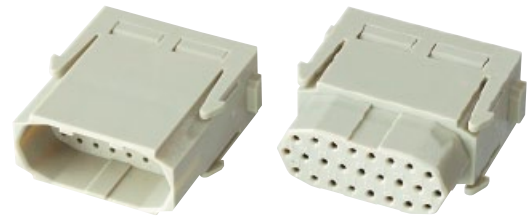

Identification	Part number		Drawing	Dimensions in mm
	Male insert (M)	Female insert (F)		
Crimp terminal Order crimp contacts separately	09 14 025 3001	09 14 025 3101	<p> M F M F Contact arrangement view from termination side </p>	

Han Modular

Identification	Wire gauge (mm²)	Part number		Drawing	Dimensions in mm												
		Male contact	Female contact														
D-Sub crimp contacts 	0,08-0,21 0,13-0,33 0,33-0,52	61 03 000 0078 61 03 000 0094 61 03 000 0073	61 03 000 0080 61 03 000 0096 61 03 000 0074	<table border="1"> <thead> <tr> <th colspan="2">Wire gauge</th> <th rowspan="2">Stripping length</th> </tr> </thead> <tbody> <tr> <td>0.08-0.21 mm²</td> <td>AWG 28-24</td> <td>5 mm</td> </tr> <tr> <td>0.13-0.33 mm²</td> <td>AWG 26-22</td> <td>5 mm</td> </tr> <tr> <td>0.33-0.52 mm²</td> <td>AWG 22-20</td> <td>5 mm</td> </tr> </tbody> </table>	Wire gauge		Stripping length	0.08-0.21 mm²	AWG 28-24	5 mm	0.13-0.33 mm²	AWG 26-22	5 mm	0.33-0.52 mm²	AWG 22-20	5 mm	
Wire gauge		Stripping length															
0.08-0.21 mm²	AWG 28-24		5 mm														
0.13-0.33 mm²	AWG 26-22	5 mm															
0.33-0.52 mm²	AWG 22-20	5 mm															
Insertion / Removal tool for D-Sub crimp contacts 		09 99 000 0368	09 99 000 0368														

06
65

Stock items in bold type

Features

- 9-pin D-Sub connector of the Han-Modular® system
- Ideal for the transmission of sensitive signals
- Compatible to crimp, solder or IDC termination
- Using of guiding pins (male and female) is recommended (see chapter 40).

Technical characteristics

Specifications	DIN EN 60 664-1 DIN EN 61 984
----------------	----------------------------------



Inserts

Number of contacts	9
Electrical data acc. to EN 61 984	5 A 50 V 0.8 kV 3
Rated current	5 A
Rated voltage	50 V
Rated impulse voltage	0.8 kV
Pollution degree	3
Insulation resistance	$\geq 10^{10} \Omega$
Material	polycarbonate
Limiting temperatures	-40 °C ... +125 °C
Flammability acc. to UL 94	V 0
Mechanical working life - mating cycles	≥ 500

Number of contacts

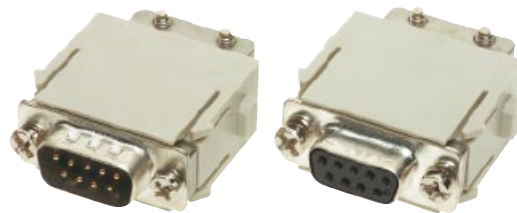
9

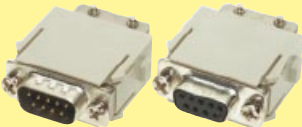
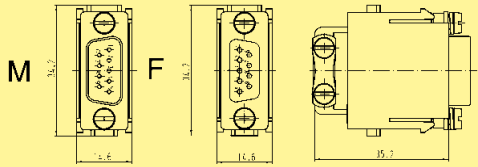

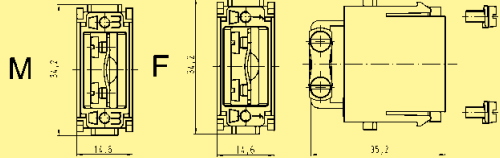
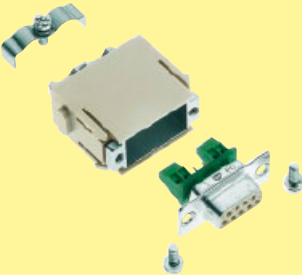
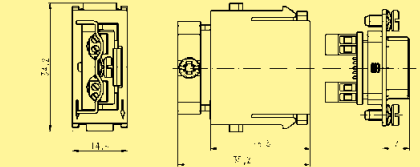
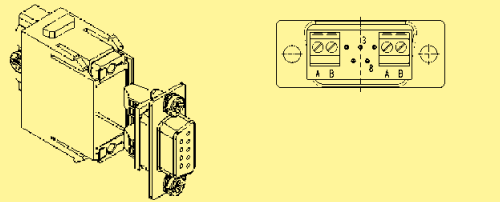
Identification	Part number		Drawing	Dimensions in mm						
	Male insert (M)	Female insert (F)								
<p>Crimp terminal Order crimp contacts separately (see page 06.65)</p> 	09 14 009 3001	09 14 009 3101								
<p>Adapter module without D-Sub insert</p> <p>for one cable</p>  <p>for two cables</p>	09 14 000 9930	09 14 000 9931								
<p>Screw terminal for RS 485-based bus systems with T-functionality</p> 		09 14 009 3151	  <p>Contact arrangement view from termination side</p> <table border="1" data-bbox="1034 1854 1375 1966"> <thead> <tr> <th>Signal</th> <th>Contact no.</th> </tr> </thead> <tbody> <tr> <td>A</td> <td>8</td> </tr> <tr> <td>B</td> <td>3</td> </tr> </tbody> </table>	Signal	Contact no.	A	8	B	3	
Signal	Contact no.									
A	8									
B	3									

Han Modular

Features

- According to USB 2.0 specification
- Simple and cost effective termination by plug in patch cable
- Cable tie strain relief

Technical characteristics

Specifications	DIN EN 60 664-1 DIN EN 61 984
----------------	----------------------------------





Inserts

Number of contacts	4
Electrical data acc. to EN 61 984	1 A 50 V 0.8 kV 3
Rated current	1 A
Rated voltage	50 V
Rated impulse voltage	0.8 kV
Pollution degree	3
Insulation resistance	≥ 10 ¹⁰ Ω
Material	polycarbonate
Limiting temperatures	-40 °C ... +85 °C
Flammability acc. to UL 94	V 0
Mechanical working life - mating cycles	≥ 500

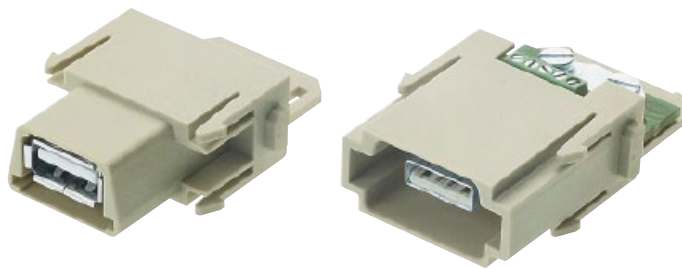
Number of contacts

4



Identification	Part number		Drawing	Dimensions in mm
	Male insert (M)	Female insert (F)		
Module for patch cable Male insert 	09 14 001 4601			
Module for patch cable Female insert 		09 14 001 4701		
Module for screw termination Male insert 	09 14 001 4651			
Patch cable USB male / male Style A 	2 m 39 50 903 0050 5 m 39 50 903 0051	2 m 39 50 903 0050 5 m 39 50 903 0051		

Han
Modular

Features

- Compatible to IEEE 1394
- Simple and cost effective termination by plug in patch cable
- Cable tie strain relief

Technical characteristics

Specifications	DIN EN 60 664-1 DIN EN 61 984
----------------	----------------------------------



Inserts

Number of contacts	6
Electrical data acc. to EN 61 984	1 A 50 V 0.8 kV 3
Rated current	1 A
Rated voltage	50 V
Rated impulse voltage	0.8 kV
Pollution degree	3
Insulation resistance	$\geq 10^{10} \Omega$
Material	polycarbonate
Limiting temperatures	-40 °C ... +85 °C
Flammability acc. to UL 94	V 0
Mechanical working life - mating cycles	≥ 500

Number of contacts

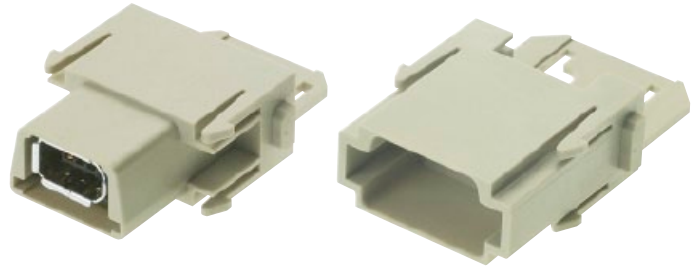
6

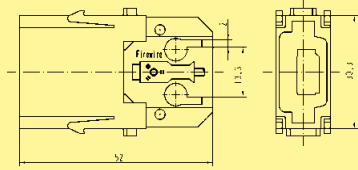

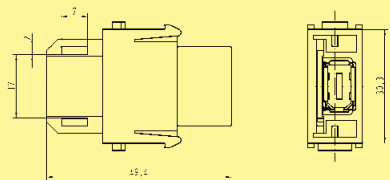
Identification	Part number		Drawing	Dimensions in mm
	Male insert (M)	Female insert (F)		
Module for patch cable Male insert 	09 14 001 4611			
Module for patch cable Female insert 		09 14 001 4711		

Han
Modular

Features

- Single module with standard shielded RJ45 plug and jack
- Cat 5e for all data pairs (all 8 pins)
- Conforming to the RoHS directive
- The RJ45 inserts are protected by a reliable plastic insulator
- Patch cables are assembled/removed without tools

Technical characteristics

Specifications	DIN EN 60 664-1 DIN EN 61 984
----------------	----------------------------------





Inserts

Number of contacts	8
Electrical data	
acc. to EN 61 984	1 A 50 V 0.8 kV 3
Rated current	1 A
Rated voltage	50 V
Rated impulse voltage	0.8 kV
Pollution degree	3
Transmission features	Category 5 / Class D up to 100 MHz; acc. to ISO/IEC 11 801:2002 and EN 50 173-1
Transmission rate	10/100 Mbit/s
Insulation resistance	$\geq 10^{10} \Omega$
Material	polycarbonate
Limiting temperatures	-40 °C ... +85 °C
Flammability acc. to UL 94	V 0
Mechanical working life	
- mating cycles	≥ 500

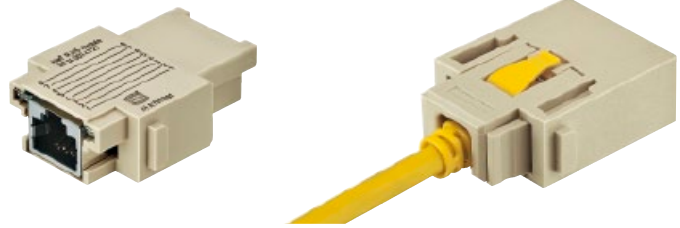
Number of contacts

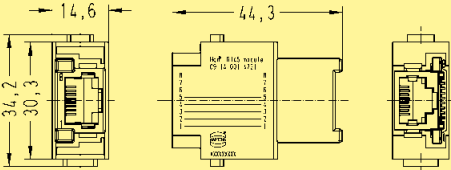
8

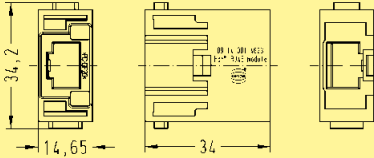

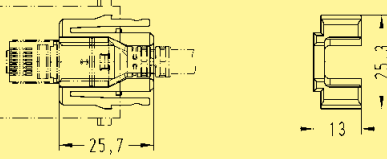
Identification	Part number		Drawing	Dimensions in mm
	Male insert (M)	Female insert (F)		
Gender Changer for patch cable 		09 14 001 4721		
Male insert for patch cable 	09 14 001 4623			
Adapter for HARTING patch cable 	09 14 000 9966			

Han
Modular

Features

- Locking lever protection for RJ45 connector latch
- Very short plug design in combination with robust bend protection
- RoHS compliant
- Fully EMC screened (aluminium-clad foil and braid)

Technical characteristics

Specifications	ISO/IEC 24 702 ISO/IEC 11 801 ISO/IEC 61 935-2
----------------	--

Cat. 5 e RJ45 patch cable

Transmission features	Category 5 / Class D up to 100 MHz; acc. to ISO/IEC 24 702 or ISO/IEC 11 801
Transmission rate	10/100/1000 Mbit/s
Cable type	1:1 EIA/TIA 568 B, 8 poles
Material cables	SF/UTP, PUR, yellow
Limiting temperatures	
- mobile	0 °C ... +60 °C
- stationary	-40 °C ... +80 °C
Flammability	flame retardant, halogen-free
Degree of protection	IP 20

Cat. 6 RJ45 patch cable

Transmission features	Category 6 / Class E up to 250 MHz; acc. to ISO/IEC 24 702 or ISO/IEC 11 801
Transmission rate	10/100/1000 Mbit/s
Cable type	1:1 EIA/TIA 568 B, 8 poles
Material cables	SF/UTP, PUR, yellow
Limiting temperatures	
- mobile	0 °C ... +60 °C
- stationary	-20 °C ... +80 °C
Flammability	flame retardant, halogen-free
Degree of protection	IP 20

Number of contacts

8



Identification

Part number

Drawing

Dimensions in mm

Cat. 5e RJ45 patch cable

Length	Part number
0.2 m	09 47 474 7001
0.3 m	09 47 474 7002
0.4 m	09 47 474 7003
0.5 m	09 47 474 7004
0.6 m	09 47 474 7005
0.7 m	09 47 474 7006
0.8 m	09 47 474 7007
0.9 m	09 47 474 7008
1.0 m	09 47 474 7009
1.5 m	09 47 474 7010
2.0 m	09 47 474 7011
2.5 m	09 47 474 7012
3.0 m	09 47 474 7013
4.0 m	09 47 474 7014
5.0 m	09 47 474 7015
6.0 m	09 47 474 7016
7.0 m	09 47 474 7017
7.5 m	09 47 474 7018
8.0 m	09 47 474 7019
9.0 m	09 47 474 7020
10 m	09 47 474 7021
15 m	09 47 474 7022
20 m	09 47 474 7023

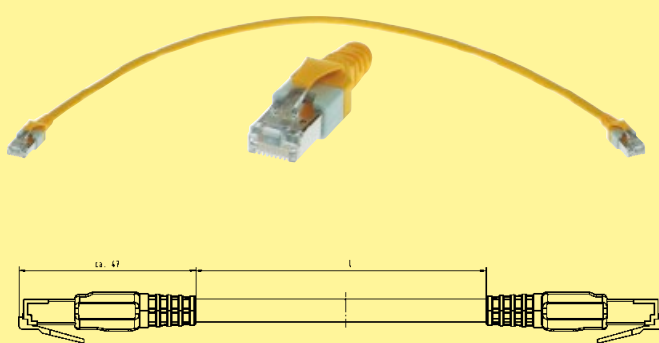

Han Modular

Cat. 6 RJ45 patch cable

Length	Part number
0.2 m	09 47 474 7101
0.3 m	09 47 474 7102
0.4 m	09 47 474 7103
0.5 m	09 47 474 7104
0.6 m	09 47 474 7105
0.7 m	09 47 474 7106
0.8 m	09 47 474 7107
0.9 m	09 47 474 7108
1.0 m	09 47 474 7109
1.5 m	09 47 474 7110
2.0 m	09 47 474 7111
2.5 m	09 47 474 7112
3.0 m	09 47 474 7113
4.0 m	09 47 474 7114
5.0 m	09 47 474 7115
6.0 m	09 47 474 7116
7.0 m	09 47 474 7117
7.5 m	09 47 474 7118
8.0 m	09 47 474 7119
9.0 m	09 47 474 7120
10 m	09 47 474 7121
15 m	09 47 474 7122
20 m	09 47 474 7123

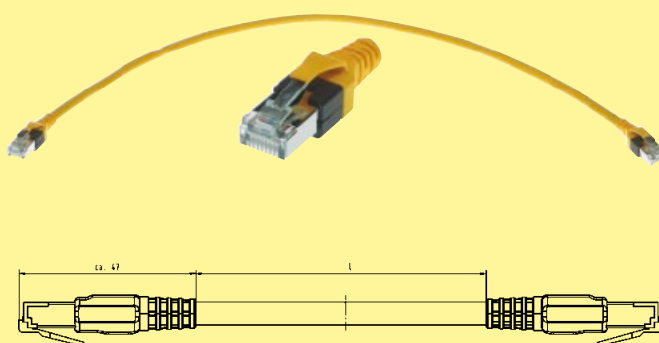

Features

Han-Modular® RJ Industrial RJ45 connector set

- Conforming to the RoHS directive
- 360° shielded contact
- Field assembly without tools possible by means of HARAX® rapid termination in IDC technology
- Suitable for termination of massive and flexible wires

Han-Modular® RJ Industrial Gigalink RJ45 connector set

- Conforming to the RoHS directive
- 360° shielded contact
- Field assembly by means of piercing contacts
- Suitable for termination of flexible wires

Technical characteristics

Specifications	IEC 60 603-7 DIN EN 60 664-1 DIN EN 61 984
----------------	--

HARTING RJ Industrial®, 4 pins

Number of contacts	4
Transmission features	Category 5 / Class D up to 100 MHz; acc. to ISO/IEC 11 801:2002 and EN 50 173-1
Transmission rate	10/100 Mbit/s
Wire termination	IDC contacts; without tools
Terminated cable	
- Conductor cross section	
flexible	AWG 24/7 ... AWG 22/7
solid	AWG 23/1 ... AWG 22/1
- Cable outside diameter	≤ 1.6 mm
Material insert	polyamide
Limiting temperatures	-40 °C ... +70 °C

HARTING RJ Industrial® Gigalink, 8 pins

Number of contacts	8
Transmission features	Category 6 / Class E up to 250 MHz; acc. to ISO/IEC 11 801:2002 and EN 50 173-1
Transmission rate	10/100/1000 Mbit/s
Wire termination	Piercing contacts
Terminated cable	
- Conductor cross section	
flexible	AWG 28/7 ... AWG 24/7
- Cable outside diameter	≤ 1.05 mm
Material insert	polyamide
Limiting temperatures	-40 °C ... +70 °C

HARTING RJ Industrial® 10G, 8 pins

Number of contacts	8
Transmission features	Category 6 / Class E up to 250 MHz; acc. to ISO/IEC 11 801:2002 and EN 50 173-1
Transmission rate	10/100/1000 Mbit/s
Wire termination	IDC contacts; without tools
Terminated cable	
- Conductor cross section	
flexible	AWG 27/7 ... AWG 22/7
solid	AWG 27/1 ... AWG 22/1
- Cable outside diameter	≤ 1.5 mm
Material insert	polyamide
Limiting temperatures	-40 °C ... +70 °C

Number of contacts

4 / 8

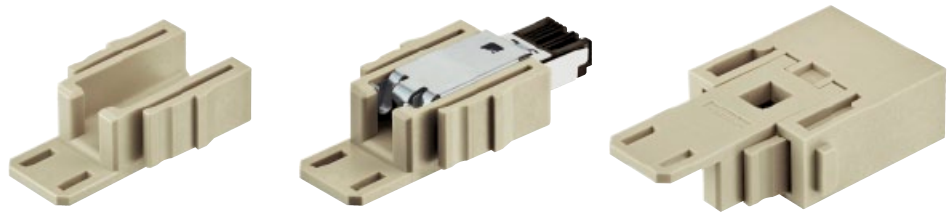

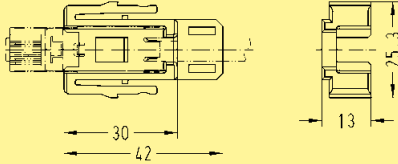
Identification	Part number Male insert (M)	Drawing	Dimensions in mm
<p>Han-Modular® RJ Industrial RJ45 connector set</p>  <p>Cat. 5 4 pins for AWG 24 ... 22 4 pins for AWG 26</p> <p>Cat. 6 Gigalink, 8 pins Gigalink, 8 pins</p> <p>Cat. 6 10G, 8 pins</p>	<p>09 45 400 1100 09 45 400 1109</p> <p>09 45 400 1500 09 45 400 1510</p> <p>09 45 400 1560</p>		<p>Set consists of the relevant RJ45 insert and the suitable adapter for Han® RJ45 module, male, part number 09 14 001 4623</p>

<p>HARTING RJ Industrial® Gigalink Assembly tool</p>	<p>09 45 800 0500</p>	
--	------------------------------	--

* usable with male insert 09 14 001 4623 (see page 06.73)

Features

- Shielding bus separate from housing potential
- Ideal for the transmission of sensitive signals (e.g. bus signals)
- Usable for Gigabit Ethernet Cat. 6

Technical characteristics

Specifications	DIN EN 60 664-1 DIN EN 61 984
----------------	----------------------------------

Inserts

Number of contacts	8
Insulation resistance	$\geq 10^{10} \Omega$
Material	polycarbonate
Limiting temperatures	-40 °C ... +125 °C
Flammability acc. to UL 94	V 0
Mechanical working life - mating cycles	≥ 500

GigaBit contacts

Number of contacts	8 + shielding
Electrical data acc. to EN 61 984	5 A 50 V 0.8 kV 3
Rated current	5 A
Rated voltage	50 V
Rated impulse voltage	0.8 kV
Pollution degree	3

Material	
- Insulator	polycarbonate
- Outer conductor	zinc alloy
Contact resistance	$\leq 4 \text{ m}\Omega$
Limiting temperatures	-40 °C ... +85 °C
Flammability acc. to UL 94	V 0
Outer surface finish	nickel
Cable diameter	5 ... 12 mm

D-Sub crimp contacts

Crimp terminal	
- mm ²	0.08 ... 0.52 mm ²
- AWG	28 ... 20
turned contacts	Performance level 1

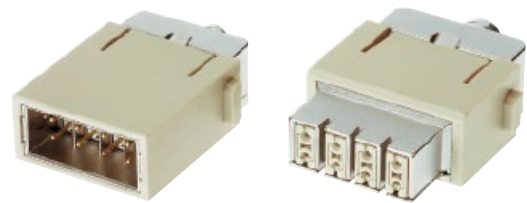

Number of contacts

8

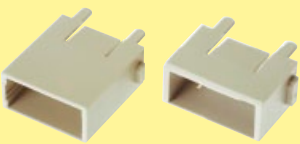
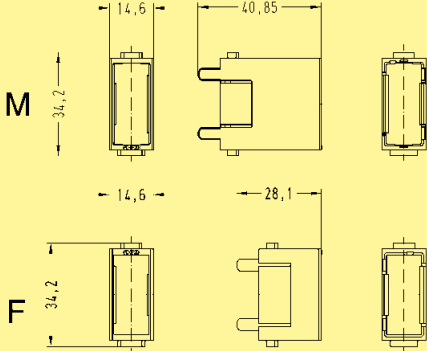

Identification	Part number		Drawing	Dimensions in mm
	Male insert (M)	Female insert (F)		
Han® GigaBit module 	09 14 001 3011	09 14 001 3111		

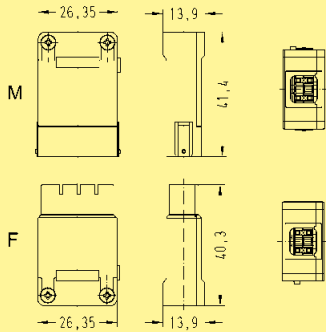
Han Modular

Identification	Wire gauge (mm²)	Part number		Drawing	Dimensions in mm												
		Male contact	Female contact														
GigaBit contacts 8 + shielding Order crimp contacts separately 		09 14 008 3011	09 14 008 3111														
D-Sub crimp contacts 	0,08-0,21 0,13-0,33 0,33-0,52	61 03 000 0078 61 03 000 0094 61 03 000 0073	61 03 000 0080 61 03 000 0096 61 03 000 0074	<table border="1"> <thead> <tr> <th colspan="2">Wire gauge</th> <th>Stripping length</th> </tr> </thead> <tbody> <tr> <td>0,08-0,21 mm²</td> <td>AWG 28-24</td> <td>5 mm</td> </tr> <tr> <td>0,13-0,33 mm²</td> <td>AWG 26-22</td> <td>5 mm</td> </tr> <tr> <td>0,33-0,52 mm²</td> <td>AWG 22-20</td> <td>5 mm</td> </tr> </tbody> </table>	Wire gauge		Stripping length	0,08-0,21 mm²	AWG 28-24	5 mm	0,13-0,33 mm²	AWG 26-22	5 mm	0,33-0,52 mm²	AWG 22-20	5 mm	
Wire gauge		Stripping length															
0,08-0,21 mm²	AWG 28-24	5 mm															
0,13-0,33 mm²	AWG 26-22	5 mm															
0,33-0,52 mm²	AWG 22-20	5 mm															

Han
Modular

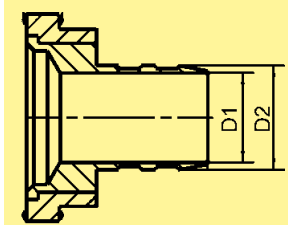
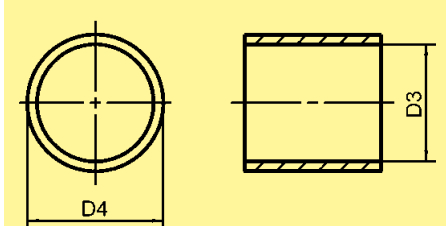
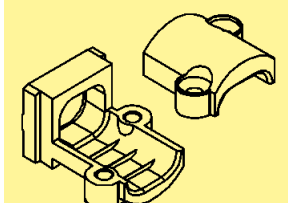
Identification	Part number	Drawing	Dimensions in mm																																																					
<p>Crimp flange</p> <table border="0" data-bbox="526 403 654 806"> <tr><td>D1</td><td>D2</td></tr> <tr><td>3.0</td><td>4.0</td></tr> <tr><td>3.5</td><td>4.5</td></tr> <tr><td>4.0</td><td>5.0</td></tr> <tr><td>4.5</td><td>5.5</td></tr> <tr><td>5.0</td><td>6.0</td></tr> <tr><td>5.5</td><td>6.5</td></tr> <tr><td>6.0</td><td>7.0</td></tr> <tr><td>6.5</td><td>7.5</td></tr> <tr><td>7.0</td><td>8.0</td></tr> <tr><td>7.5</td><td>8.5</td></tr> <tr><td>8.0</td><td>9.0</td></tr> <tr><td>8.5</td><td>9.5</td></tr> <tr><td>9.0</td><td>10.0</td></tr> </table>	D1	D2	3.0	4.0	3.5	4.5	4.0	5.0	4.5	5.5	5.0	6.0	5.5	6.5	6.0	7.0	6.5	7.5	7.0	8.0	7.5	8.5	8.0	9.0	8.5	9.5	9.0	10.0	<table border="0" data-bbox="686 448 861 806"> <tr><td>61 03 000 0062</td></tr> <tr><td>61 03 000 0063</td></tr> <tr><td>61 03 000 0064</td></tr> <tr><td>61 03 000 0065</td></tr> <tr><td>61 03 000 0066</td></tr> <tr><td>61 03 000 0166</td></tr> <tr><td>61 03 000 0067</td></tr> <tr><td>61 03 000 0068</td></tr> <tr><td>61 03 000 0069</td></tr> <tr><td>61 03 000 0070</td></tr> <tr><td>61 03 000 0071</td></tr> <tr><td>61 03 000 0165</td></tr> <tr><td>61 03 000 0072</td></tr> </table>	61 03 000 0062	61 03 000 0063	61 03 000 0064	61 03 000 0065	61 03 000 0066	61 03 000 0166	61 03 000 0067	61 03 000 0068	61 03 000 0069	61 03 000 0070	61 03 000 0071	61 03 000 0165	61 03 000 0072														
D1	D2																																																							
3.0	4.0																																																							
3.5	4.5																																																							
4.0	5.0																																																							
4.5	5.5																																																							
5.0	6.0																																																							
5.5	6.5																																																							
6.0	7.0																																																							
6.5	7.5																																																							
7.0	8.0																																																							
7.5	8.5																																																							
8.0	9.0																																																							
8.5	9.5																																																							
9.0	10.0																																																							
61 03 000 0062																																																								
61 03 000 0063																																																								
61 03 000 0064																																																								
61 03 000 0065																																																								
61 03 000 0066																																																								
61 03 000 0166																																																								
61 03 000 0067																																																								
61 03 000 0068																																																								
61 03 000 0069																																																								
61 03 000 0070																																																								
61 03 000 0071																																																								
61 03 000 0165																																																								
61 03 000 0072																																																								
<p>Crimp ferrule</p> <table border="0" data-bbox="526 918 654 1411"> <tr><td>D3</td><td>D4</td></tr> <tr><td>5.0</td><td>6.0</td></tr> <tr><td>5.5</td><td>6.5</td></tr> <tr><td>6.0</td><td>7.0</td></tr> <tr><td>6.5</td><td>7.5</td></tr> <tr><td>7.0</td><td>8.0</td></tr> <tr><td>7.5</td><td>8.5</td></tr> <tr><td>8.0</td><td>9.0</td></tr> <tr><td>8.5</td><td>9.5</td></tr> <tr><td>9.0</td><td>10.0</td></tr> <tr><td>9.5</td><td>10.5</td></tr> <tr><td>10.0</td><td>11.0</td></tr> <tr><td>10.5</td><td>11.5</td></tr> <tr><td>11.0</td><td>12.0</td></tr> <tr><td>11.5</td><td>12.5</td></tr> <tr><td>12.0</td><td>13.0</td></tr> <tr><td>12.5</td><td>13.5</td></tr> <tr><td>13.0</td><td>14.0</td></tr> </table>	D3	D4	5.0	6.0	5.5	6.5	6.0	7.0	6.5	7.5	7.0	8.0	7.5	8.5	8.0	9.0	8.5	9.5	9.0	10.0	9.5	10.5	10.0	11.0	10.5	11.5	11.0	12.0	11.5	12.5	12.0	13.0	12.5	13.5	13.0	14.0	<table border="0" data-bbox="686 963 861 1411"> <tr><td>61 03 000 0045</td></tr> <tr><td>61 03 000 0046</td></tr> <tr><td>61 03 000 0047</td></tr> <tr><td>61 03 000 0048</td></tr> <tr><td>61 03 000 0049</td></tr> <tr><td>61 03 000 0050</td></tr> <tr><td>61 03 000 0051</td></tr> <tr><td>61 03 000 0052</td></tr> <tr><td>61 03 000 0053</td></tr> <tr><td>61 03 000 0054</td></tr> <tr><td>61 03 000 0055</td></tr> <tr><td>61 03 000 0056</td></tr> <tr><td>61 03 000 0057</td></tr> <tr><td>61 03 000 0058</td></tr> <tr><td>61 03 000 0142</td></tr> <tr><td>61 03 000 0059</td></tr> <tr><td>61 03 000 0127</td></tr> </table>	61 03 000 0045	61 03 000 0046	61 03 000 0047	61 03 000 0048	61 03 000 0049	61 03 000 0050	61 03 000 0051	61 03 000 0052	61 03 000 0053	61 03 000 0054	61 03 000 0055	61 03 000 0056	61 03 000 0057	61 03 000 0058	61 03 000 0142	61 03 000 0059	61 03 000 0127		
D3	D4																																																							
5.0	6.0																																																							
5.5	6.5																																																							
6.0	7.0																																																							
6.5	7.5																																																							
7.0	8.0																																																							
7.5	8.5																																																							
8.0	9.0																																																							
8.5	9.5																																																							
9.0	10.0																																																							
9.5	10.5																																																							
10.0	11.0																																																							
10.5	11.5																																																							
11.0	12.0																																																							
11.5	12.5																																																							
12.0	13.0																																																							
12.5	13.5																																																							
13.0	14.0																																																							
61 03 000 0045																																																								
61 03 000 0046																																																								
61 03 000 0047																																																								
61 03 000 0048																																																								
61 03 000 0049																																																								
61 03 000 0050																																																								
61 03 000 0051																																																								
61 03 000 0052																																																								
61 03 000 0053																																																								
61 03 000 0054																																																								
61 03 000 0055																																																								
61 03 000 0056																																																								
61 03 000 0057																																																								
61 03 000 0058																																																								
61 03 000 0142																																																								
61 03 000 0059																																																								
61 03 000 0127																																																								
<p>Cable clamp</p> <p data-bbox="287 1545 654 1635"> cable diameter approx. 5 ... 7 mm cable diameter approx. 7 ... 10 mm cable diameter approx. 10 ... 12 mm </p>	<table border="0" data-bbox="686 1545 861 1635"> <tr><td>61 03 000 0141</td></tr> <tr><td>61 03 000 0044</td></tr> <tr><td>61 03 000 0143</td></tr> </table>	61 03 000 0141	61 03 000 0044	61 03 000 0143																																																				
61 03 000 0141																																																								
61 03 000 0044																																																								
61 03 000 0143																																																								

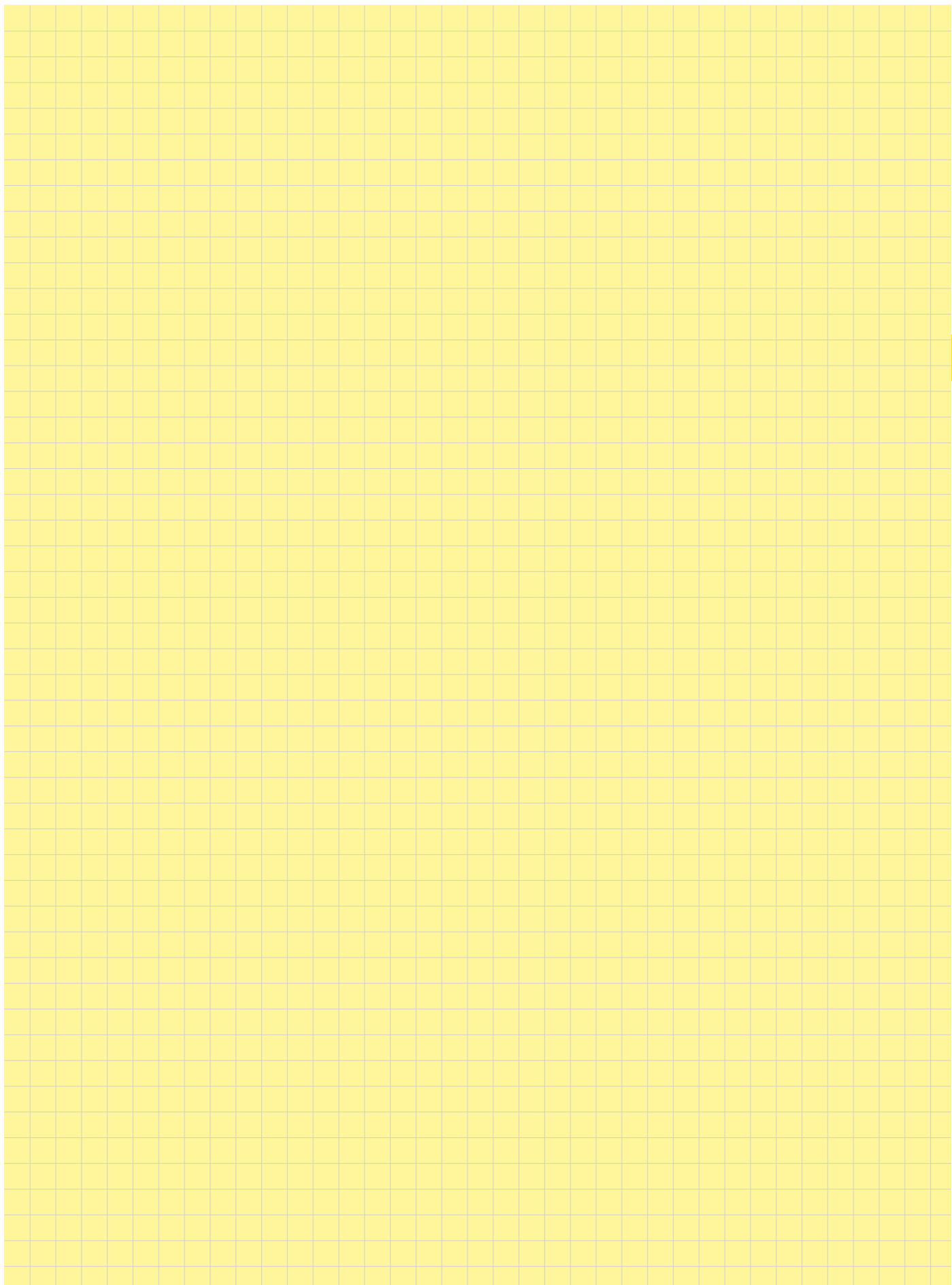

Features

- Shielding bus separate from housing potential
- Perfect for transmission of sensitive signals (eg. bus signals)
- The four pole Han® Quintax contact is suitable for Ethernet Cat. 5e and PROFIBUS when diagonally wiring of the data pairs.

Technical characteristics

Specifications DIN EN 60 664-1
 DIN EN 61 984

Approvals 

Inserts

Number of contacts 2

Insulation resistance $\geq 10^{10} \Omega$
 Material polycarbonate
 Limiting temperatures -40 °C ... +125 °C
 Flammability acc. to UL 94 V 0
 Mechanical working life
 - mating cycles ≥ 500

Quintax contacts

Number of contacts
 - Quintax 4 + shielding
 - High Density Quintax 8 + shielding

Electrical data
 acc. to EN 61 984
 - Quintax **10 A 50 V 0.8 kV 3**
 - High Density Quintax **5 A 50 V 0.8 kV 3**
 Rated current 10 A / 5 A
 Rated voltage 50 V
 Rated impulse voltage 0.8 kV
 Pollution degree 3

Material
 - Insulator polycarbonate
 - Outer conductor zinc alloy
 Contact resistance $\leq 4 \text{ m}\Omega$
 Limiting temperatures -40 °C ... +85 °C
 Flammability acc. to UL 94 V 0
 Outer surface finish nickel
 Cable diameter 3 ... 9.5 mm

Han D® contacts

Material copper alloy
 Surface
 - hard-gold plated 2 μm Au over 3 μm Ni
 Contact resistance $\leq 3 \text{ m}\Omega$
 Crimp terminal
 - mm² 0.14 ... 2.5 mm²
 - AWG 26 ... 14

D-Sub crimp contacts

Crimp terminal
 - mm² 0.08 ... 0.52 mm²
 - AWG 28 ... 20
 turned contacts Performance level 1

Number of contacts

2

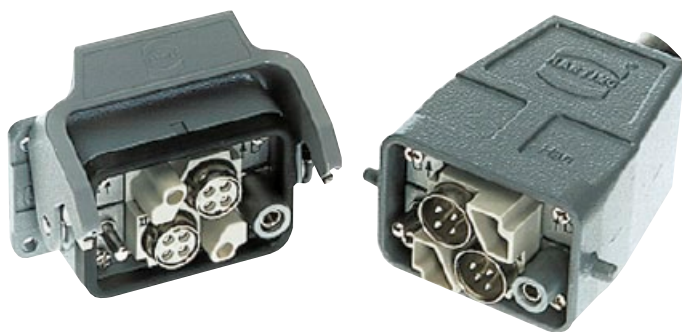

Identification	Part number		Drawing	Dimensions in mm
	Male insert (M)	Female insert (F)		
<p>Crimp terminal</p>	09 14 002 3001	09 14 002 3101	<p>M</p> <p>F</p> <p>Contact arrangement view from termination side</p>	
<p>Quintax metal adapter option</p>	09 14 000 9915	09 14 000 9915		

Han Modular

Identification	Wire gauge (mm ²)	Part number		Drawing	Dimensions in mm
		Male contact	Female contact		
<p>Quintax contact 4 + shielding Han D® crimp contacts</p>		09 15 004 3013	09 15 004 3113		
<p>Han D® Crimp contact gold plated</p>	0.14-0.37 0.5 0.75 1 1.5 2.5	09 15 000 6124 09 15 000 6123 09 15 000 6125 09 15 000 6122 09 15 000 6121 09 15 000 6126	09 15 000 6224 09 15 000 6223 09 15 000 6225 09 15 000 6222 09 15 000 6221 09 15 000 6226		
<p>High Density Quintax contact 8 + shielding Han® D-Sub contacts</p>		09 15 008 3013	09 15 008 3113		
<p>D-Sub crimp contact</p>	0.08-0.21 0.13-0.33 0.33-0.52	61 03 000 0078 61 03 000 0094 61 03 000 0073	61 03 000 0080 61 03 000 0096 61 03 000 0074		

Order crimp contacts separately

Stock items in bold type

Features

- Well known Quintax concept
- Suitable for contacts with large diameters
- Han E® coax is applicable to the ETCS Eurobalise cable

RF transmission characteristics

Impedance 75 Ω

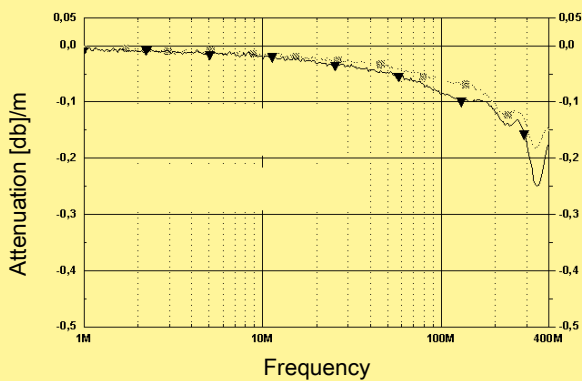

- 75 Ω cable
- 75 Ω cable with Han D® Coax
- 75 Ω coax cable diameter shielding: 7.3 mm

Impedance 50 Ω

Han E® Coax with ETCS S21 Eurobalise cable (4 mm ²)	27 MHz
Return loss [db]	35.4
Attenuation [db]	0.017

Han E® Coax with RG 213 cable (2.5 mm ²)	200 MHz	500 MHz	1.0 GHz	1.2 GHz	1.5 GHz	2.0 GHz	2.5 GHz
Return loss [db]	23.8	21.1	>18.7	>17.7	>16.4	>14.1	>12.0
Attenuation [db]	0.07	0.11	0.17	0.2	<0.23	<0.53	<2.0

Technical characteristics

Specifications DIN EN 60 664-1
DIN EN 61 984

Approvals

Inserts

Number of contacts 2
Insulation resistance $\geq 10^{10} \Omega$
Material polycarbonate
Limiting temperatures -40 °C ... +125 °C
Flammability acc. to UL 94 V 0
Mechanical working life - mating cycles ≥ 500

Coax contacts

Number of contacts 1 + shielding
Electrical data acc. to EN 61 984
- Han D® Coax **10 A 50 V 0.8 kV 3**
- Han E® Coax **16 A 50 V 0.8 kV 3**
Rated current 10 A / 16 A
Rated voltage 50 V
Rated impulse voltage 0.8 kV
Pollution degree 3
Impedance
- Han D® Coax 75 Ω
- Han E® Coax 50 Ω
Material
- Insulator polycarbonate
- Outer conductor zinc alloy
Contact resistance $\leq 4 \text{ m}\Omega$
Limiting temperatures -40 °C ... +85 °C
Flammability acc. to UL 94 V 0
Outer surface finish nickel
Cable diameter 3 ... 9.5 mm

Han D® contacts

Material copper alloy
Surface
- hard-gold plated 2 μm Au over 3 μm Ni
Contact resistance $\leq 3 \text{ m}\Omega$
Crimp terminal
- mm² 0.14 ... 2.5 mm²
- AWG 26 ... 14

Han E® contacts



Material copper alloy
Surface
- hard-gold plated 2 μm Au over 3 μm Ni
Contact resistance $\leq 1 \text{ m}\Omega$
Crimp terminal
- mm² 0.14 ... 5.5 mm²
- AWG 26 ... 10

Number of contacts

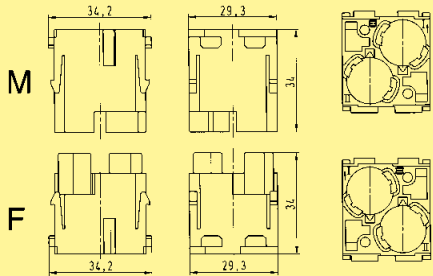
2

Identification	Part number		Drawing	Dimensions in mm
	Male insert (M)	Female insert (F)		
<p>Crimp terminal</p> 	09 14 002 3001	09 14 002 3101	 <p>M</p> <p>F</p> <p>Contact arrangement view from termination side</p>	

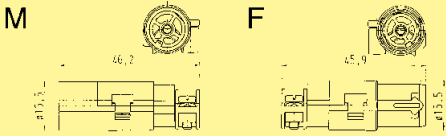
Han Modular

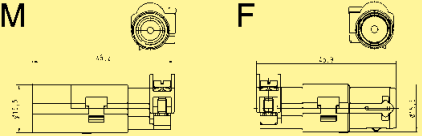
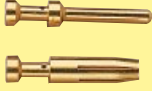
Identification	Wire gauge (mm ²)	Part number		Drawing	Dimensions in mm
		Male contact	Female contact		
<p>Han® D Coax contact 1 + shielding, 75 Ω Han D® crimp contacts</p> 		09 15 001 3013	09 15 001 3113	 <p>M</p> <p>F</p>	
<p>Han D® Crimp contact gold plated</p> 	0.14-0.37	09 15 000 6124	09 15 000 6224		
	0.5	09 15 000 6123	09 15 000 6223		
	0.75	09 15 000 6125	09 15 000 6225		
	1	09 15 000 6122	09 15 000 6222		
	1.5	09 15 000 6121	09 15 000 6221		
	2.5	09 15 000 6126	09 15 000 6226		
<p>Han® E Coax contact 1 + shielding, 50 Ω Han E® crimp contacts</p> 		09 15 001 3023	09 15 001 3123	 <p>M</p> <p>F</p>	
<p>Han E® contacts gold plated</p> 	0.14-0.37	09 33 000 6117	09 33 000 6217		
	0.5	09 33 000 6122	09 33 000 6222		
	0.75	09 33 000 6115	09 33 000 6215		
	1	09 33 000 6118	09 33 000 6218		
	1.5	09 33 000 6116	09 33 000 6216		
	2.5	09 33 000 6123	09 33 000 6223		
	4	09 33 000 6119	09 33 000 6221		
	5.5	09 33 000 6139	09 33 000 6239		

Order crimp contacts separately

Stock items in bold type

Features

- Suitable for FOC and coaxial contacts acc. to DIN 41 626
- Using of guiding pins (male and female) is imperative (see chapter 40).

Contact arrangement

according to following matrix

Contacts	Male insert (M) 09 14 004 4501	Female insert (F) 09 14 004 4512
Coaxial contacts	09 14 000 62xx	09 14 000 61xx
F.O. contacts	20 10 xxx 421x	20 10 xxx 422x

Coaxial cables (group 2)

Wires	Shell ∅	Internal wire ∅	Attenuation db/100 m at		
			100 MHz	200 MHz	800 MHz
50 Ω					
RG 174 / U	2.5	0.48	29	40	84
RG 188 A / U	2.6	0.54			
RG 316 / U	2.5	0.54			
75 Ω					
RG 179 B / U	2.55	0.3	41	41	
RG 187 A / U	2.7	0.3			

Technical characteristics

Specifications DIN EN 60 664-1
DIN EN 61 984

Approvals

Inserts

Number of contacts 4
 Insulation resistance $\geq 10^{10} \Omega$
 Material polycarbonate
 Limiting temperatures $-40 \text{ °C} \dots +125 \text{ °C}$
 Flammability acc. to UL 94 V 0
 Mechanical working life
 - mating cycles ≥ 500

Contacts

Coaxial contacts

Material copper alloy
 Surface
 - hard-gold plated demand level 2
 Impedance 50 Ω / 75 Ω
 Contact resistance
 - Internal wire $\leq 10 \text{ m}\Omega$
 - Outer conductor $\leq 3 \text{ m}\Omega$
 Rated current 1.5 A
 Rated voltage 50 V

F.O. contacts

Fibre type Glas fibre (GI)
 Attenuation < 1.5 dB

F.O. contacts

Fibre type Polymer Optical Fibre (POF)
 Attenuation < 2.5 dB

Assembly instructions

Stripping de-
scription

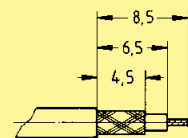

Assembly details
for coaxial contacts

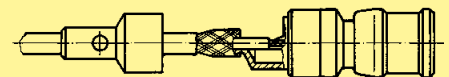

Crimp barrel solder

Solder temperature approx. 300 °C
 Solder duration approx. 2 s

Due to the closed entry design of female insert the upper part has to be removed by screw driver (7 mm) before extracting the contacts. In this case the module will be destroyed.

Number of contacts

4

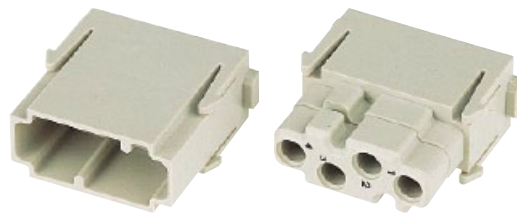

Identification	Part number		Drawing	Dimensions in mm
	Male insert (M)	Female insert (F)		
Multicontact module acc. to DIN 41 626 Order contacts separately	09 14 004 4501	09 14 004 4512	<p>Contact arrangement view from termination side</p>	

Han
Modular

Identification	Impedance	Part number		Drawing	Dimensions in mm
Coaxial contacts acc. to DIN 41 626* Solder / crimp contact 	50 Ω 75 Ω	09 14 000 6211 09 14 000 6221	09 14 000 6111 09 14 000 6121	<p>For cable group 2 flexible wires</p>	
F.O. contacts acc. to DIN 41 626 for SI fibre (HCS®) 200/230 μm for GI fibre 50/125 μm or 62.5/125 μm ceramic ferrule for 1 mm plastic fibre 		20 10 230 4211 20 10 125 4212 20 10 001 4211	20 10 230 4221 20 10 125 4222 20 10 001 4221		

* Using of guiding pins is imperative (see chapter 40).

Stock items in bold type

Features

- Suitable for coaxial contacts acc. to D-Sub (DIN 41 652)
- Using of guiding pins (male and female) is recommended (see chapter 40).

Technical characteristics

Specifications DIN EN 60 664-1
 DIN EN 61 984

Approvals 

Inserts

Number of contacts 4
 Insulation resistance $\geq 10^{10} \Omega$
 Material polycarbonate
 Limiting temperatures -40 °C ... +125 °C
 Flammability acc. to UL 94 V 0
 Mechanical working life
 - mating cycles ≥ 500

Contacts

Coaxial contacts
 Material copper alloy
 Surface
 - hard-gold plated demand level 2, S4
 Impedance 50 Ω / 75 Ω
 Contact resistance
 - Internal wire $\leq 10 \text{ m}\Omega$
 - Outer conductor $\leq 3 \text{ m}\Omega$
 Rated current 1.5 A
 Rated voltage 50 V

Contact arrangement

according to following matrix

Contacts	Male insert (M) 09 14 004 4501	Female insert (F) 09 14 004 4513
Coaxial contacts	09 14 000 62xx	09 14 000 61xx
Coaxial contacts	09 69 28x 5xxx	09 69 18x 5xxx

Number of contacts

4

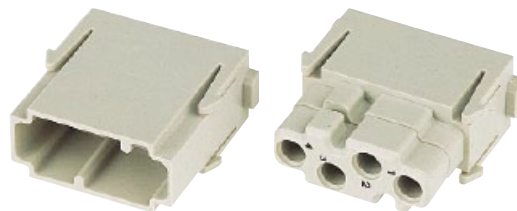

Identification	Part number		Drawing	Dimensions in mm
	Male insert (M)	Female insert (F)		
Multicontact module acc. to D-Sub Order contacts separately	09 14 004 4501	09 14 004 4513*		

Han
Modular

Identification	Impedance	Part number		Drawing	Dimensions in mm
Coaxial contacts acc. to D-Sub Performance level 2 Solder / solder contact	50 Ω	09 14 000 6215	09 14 000 6115		RG 58
Solder / crimp contact Performance level S4		09 69 281 5140	09 69 181 5140	RG 174 U, 188 AU, 316 U RG 178 BU, 196 AU, 404 U RG 58 CU, 141 AU RG 179 BU, 187 AU	
		50 Ω	09 69 281 5141		09 69 181 5141
	50 Ω	09 69 281 5143	09 69 181 5143		
	75 Ω	09 69 281 5230	09 69 181 5230		
Crimp / crimp terminal Performance level S4	50 Ω	09 69 282 5140	09 69 182 5140	RG 174 U, 188 AU, 316 U RG 179 BU, 187 AU	
		75 Ω	09 69 282 5230		09 69 182 5230

* Due to the closed entry design of female insert the upper part has to be removed by screw driver (7 mm) before extracting the contacts. In this case the module will be destroyed.

Stock items in bold type

Features

- For the transmission of clean and dry compressed
- Female contacts with / without shut off
- Removal of tubes from pre-assembled pneumatic contacts is possible

Shut off principle:

In the disconnected position the spring integrated in the female contact is active, thus the O-ring of the valve seals the opening of the air-way. During the mating process, when the defined depth of insertion is reached the male contact presses on the valve head and moves it backwards against the spring tension, so that the air-way opens.

Using of guiding pins in connection with pneumatic modules is imperative.

In addition to this guiding pins guarantee a coding, if pneumatic modules are used exclusively.

Technical characteristics

Approvals 

Inserts *

Number of contacts	2
Colour	blue
Material	polycarbonate
Limiting temperatures	-40 °C ... +80 °C
Flammability acc. to UL 94	V 0
Mechanical working life - mating cycles	≥ 500

Contacts

Material	delrin acetal
Colour	black
Tube termination - Internal diameter (ID)	6.0 mm / 1/4"
Working pressure	up to 8 bar / 116 psi

Sealing

Material	Buna-N
----------	--------

Shut off valve

Material	Polypropylen
----------	--------------

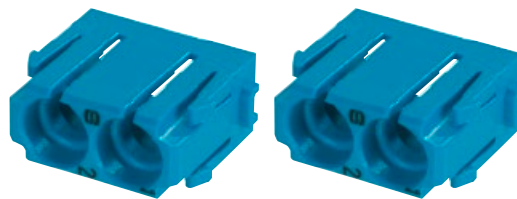

Number of contacts

2

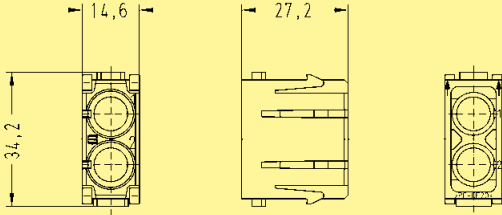

Identification	Part number		Drawing	Dimensions in mm
	Male insert (M)	Female insert (F)		
for 6 mm Order contacts separately 	09 14 002 4501*	09 14 002 4501*	 <p>Contact arrangement view from termination side</p>	

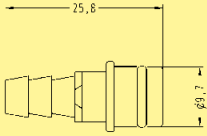
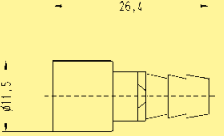
Han Modular

Identification	ID (mm)	Part number		Drawing	Dimensions in mm
		Male contact	Female contact		
Pneumatic contacts without shut off for tube internal diameter (ID) 	6.0	09 14 000 6174	09 14 000 6274	 <p>Male contact</p>	 <p>Female contact</p>
Pneumatic contacts with shut off for tube internal diameter (ID) 					

* Using of guiding pins is imperative (see chapter 40).

Stock items in bold type

Features

- For the transmission of clean and dry compressed
- Female contacts with / without shut off
- Removal of tubes from pre-assembled pneumatic contacts is possible

Shut off principle:

In the disconnected position the spring integrated in the female contact is active, thus the O-ring of the valve seals the opening of the air-way. During the mating process, when the defined depth of insertion is reached the male contact presses on the valve head and moves it backwards against the spring tension, so that the air-way opens.

Using of guiding pins in connection with pneumatic modules is imperative.

In addition to this guiding pins guarantee a coding, if pneumatic modules are used exclusively.

Technical characteristics

Approvals 

Inserts *

Number of contacts	3
Colour	blue
Material	polycarbonate
Limiting temperatures	-40 °C ... +80 °C
Flammability acc. to UL 94	V 0
Mechanical working life - mating cycles	≥ 500

Contacts

Material	delrin acetal
Colour	black
Tube termination	
- Internal diameter (ID)	1.6 mm / 1/16" 3.0 mm 4.0 mm / 1/8"
Working pressure	up to 8 bar / 116 psi

Sealing

Material	Buna-N
----------	--------

Shut off valve

Material	Polypropylen
----------	--------------

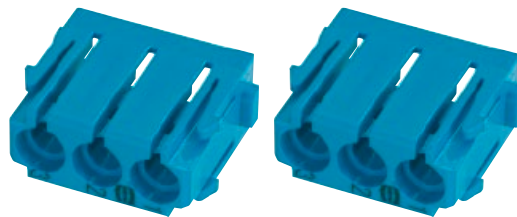

Number of contacts

3

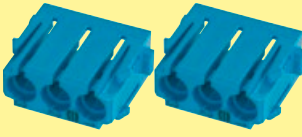
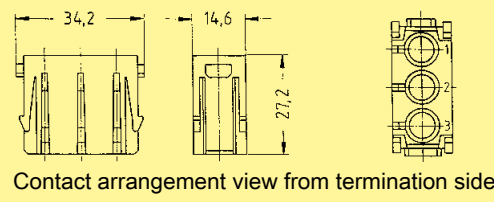

Identification	Part number		Drawing	Dimensions in mm
	Male insert (M)	Female insert (F)		
for 1.6; 3; 4 mm Order contacts separately 	09 14 003 4501*	09 14 003 4501*	 <p>Contact arrangement view from termination side</p>	

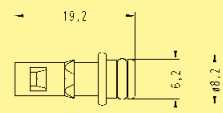
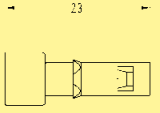
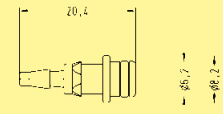
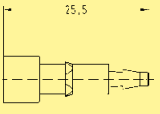
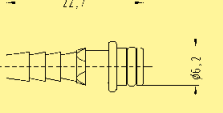
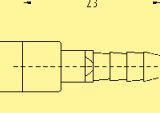
Han
Modular

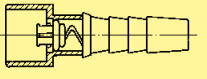
Identification	ID (mm)	Part number		Drawing	Dimensions in mm
		Male contact	Female contact		
Pneumatic contacts without shut off for tube internal diameter (ID) 	1.6	09 14 000 6151	09 14 000 6251	Male contact:  Female contact: 	
	3.0	09 14 000 6152	09 14 000 6252	Male contact:  Female contact: 	
	4.0	09 14 000 6153	09 14 000 6253	Male contact:  Female contact: 	
Pneumatic contacts with shut off for tube internal diameter (ID) 	1.6 3.0 4.0		09 14 000 6256 09 14 000 6257 09 14 000 6258	 female contact with shut off in closed position	

* Using of guiding pins is imperative (see chapter 40).

Stock items in bold type

Features

- Suitable for HARTING SC contacts
- For GI-Fibre 50 - 62.5 / 125µm
- Using of guiding pins (male and female) is recommended (see chapter 40).

Technical characteristics

Inserts

Number of contacts	4
Insertion loss	< 0.5 dB
Material	polycarbonate
Limiting temperatures	-40 °C ... +85 °C
Flammability acc. to UL 94	V 0
Mechanical working life	≥ 500
- mating cycles	

Han
Modular

Assembly instructions

Male insert (09 14 004 4701)

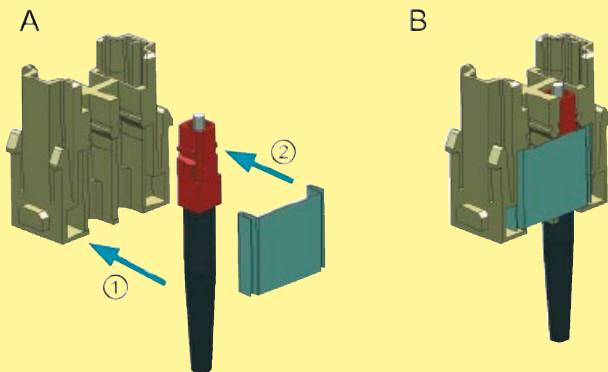

A Assemble the SC contact

Push the SC contact from the side into the relevant insert (1)
Push the fixing plate from the side over the contacts (2)

B SC contact fixed in the module

Female insert (09 14 004 4711)

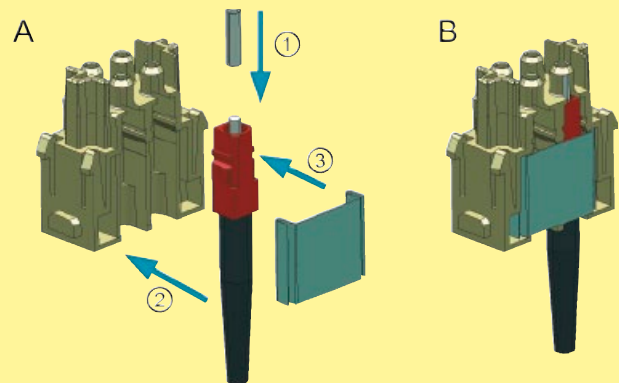

A Assemble the SC contact



Push the centering ferrule (included in delivery) on the SC contact (1)
Push the SC contact from the side into the relevant insert (2)
Push the fixing plate from the side over the contacts (3)

B SC contact fixed in the module

Number of contacts

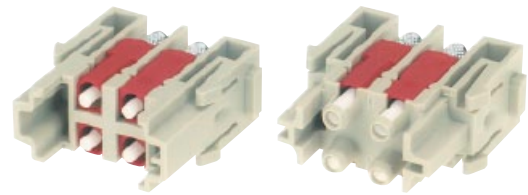
4

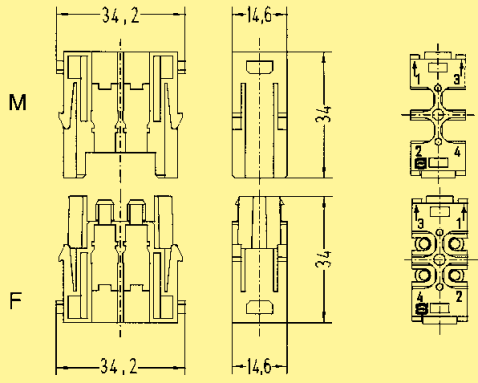

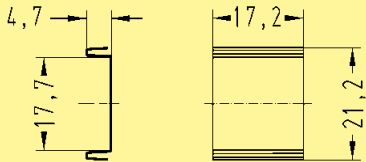
Identification	Part number		Drawing	Dimensions in mm
	Male insert (M)	Female insert (F)		
<p>SC module</p> <p>Order contacts separately</p> 	09 14 004 4701	09 14 004 4711*	 <p>Contact arrangement view from termination side</p>	
<p>Fixing plate</p> 	09 14 000 9965	09 14 000 9965		

Han Modular

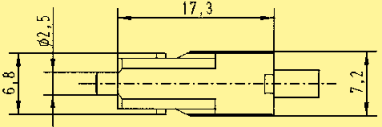
Identification	Part number		Drawing	Dimensions in mm
	Male contact	Female contact		
<p>SC contact</p> <p>for GI fibre 50/125 µm or 62.5/125 µm ceramic ferrule</p> 	20 10 125 5211	20 10 125 5211		
<p>for SI fibre (HCS®) 200/230 µm</p>	20 10 230 5211	20 10 230 5211		
<p>with quick assembly technique for 1 mm POF</p>	20 10 001 5217	20 10 001 5217		
<p>with crimp technique for 1 mm POF</p>	20 10 001 5211	20 10 001 5211		

* The female inserts are equipped with centering ferrules. 4 ferrules are included in delivery range.

Stock items in bold type

Features

- Signal pre-processing and conversion do fit into the connector
- Individual combination of input and output modules for optimal signal pre-processing
- Minimum size for integration in Han® industrial connectors (Han-Modular® and Han-Snap®)
- Economy of space by reduction the number of terminal blocks and interface modules in the switch cabinet

Technical characteristics

Power supply

(combination input and output module)

Supply voltage	24 V (-10 % ... +25 %)
Current consumption	< 0.08 A
Power consumption	< 2 W
Total transmission error	< 0.2 %

Han
Modular

General description

The Han-Elisa® modules are a flexible I/O system - directly in the connector.

The input and output modules are developed for 1 or 2 channels and can be combined variously and flexible for optimal signal pre-processing. Within the product family modules are available for current/voltage conversion, temperature, relay and timer.

Due to the minimized size these modules can be integrated into the Han-Modular® and Han-Snap® system.

Signal pre-processing and conversion do fit into the connector and this will reduce installation space for terminal blocks and the number of interface modules. So the switch cabinets can be made smaller.

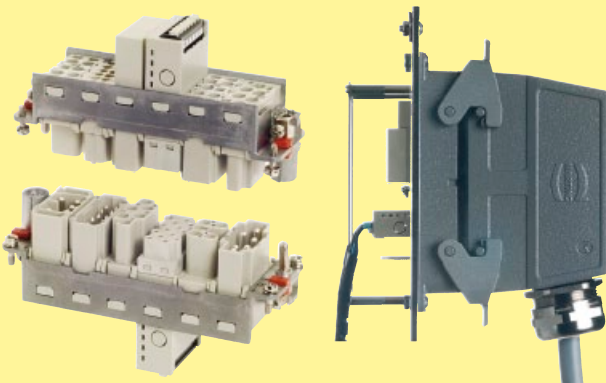

Product matrix and possible combinations

input module (male)	output module (female)	Relay Different versions	Optocoupler Different versions	Output current 4 ... 20 mA galvanically isolated	Output voltage 0 ... 10 V galvanically isolated
Timing		○	○		
Connecting 1:1		○	○		
Temperature Pt100 Different temperature ranges				●	●
Temperature thermo element type J, K Different temperature ranges				○	○
Input current 4 ... 20 mA				○	○
Input voltage 0 ... 10 V				○	○

○ = on request
● = available

Features

- Minimum size for integration in Han® industrial connectors (Han-Modular® and Han-Snap®)
- Economy of space by reduction the number of terminal blocks and interface modules in the switch cabinet
- Male module for signal input

Technical characteristics

Inserts

Sensor	Pt100 acc. to IEC 751
Termination technology	2-, 3-, 4 wire technology
Sensor input current	0.8 mA, constant
Conductor resistance, max. permissible	10 Ω per conductor
Min. measuring range	100 °C
Open circuit detection	integrated

Material	polycarbonate / LCP
Termination	Cage-clamp terminal
- mm ²	0.14 ... 1.5 mm ²
- AWG	26 ... 16

Power diagnostic	LED (green)
------------------	-------------

Temperature range

Working temperature	-20 °C ... +65 °C
Stock temperature	-40 °C ... +85 °C



Pt100 Input module

Identification		Part number Male insert (M)	Drawing	Dimensions in mm
Temperature module Pt100				
Measuring range	0 ... 100 °C	20 75 108 1101		
	0 ... 200 °C	20 75 108 1103		
Additional measuring ranges on request				

Han
Modular

Features

- Minimum size for integration in Han[®] industrial connectors (Han-Modular[®] and Han-Snap[®])
- Economy of space by reduction the number of terminal blocks and interface modules in the switch cabinet
- Female module for signal output

Technical characteristics

Inserts

Supply voltage	24 V (-10 % ... +25 %)
Load I_{out}	< 500 Ω
Load U_{out}	\geq 10 k Ω
Residual ripple	< 20 mV (500 Ω)
Step response (0 ... 99 %)	< 30 ms

Material	polycarbonate / LCP
Termination	Cage-clamp terminal
- mm ²	0.14 ... 1.5 mm ²
- AWG	26 ... 16

Power diagnostic	LED (green)
------------------	-------------

Temperature range

Working temperature	-20 °C ... +65 °C
Stock temperature	-40 °C ... +125 °C



Output module

Identification	Part number Female insert (F)	Drawing	Dimensions in mm
<p>Output module, current 3-ways-isolating amplifier; galvanically isolated</p> <p>Output signal 4 ... 20 mA</p> <p>Additional output signal ranges on request</p>	<p>20 75 104 2201</p>		
<p>Output module, voltage 3-ways-isolating amplifier; galvanically isolated</p> <p>Output signal 0 ... 10 V</p> <p>Additional output signal ranges on request</p>	<p>20 75 105 2201</p>		

Han
Modular

Features

- Coding of tools possible (e.g. press tools) by means of an alphanumeric identification
- I²C bus EEPROM as memory medium
- Communication with PLC via conventional digital I/Os
- Physical connection of PLC by means of well-proven Han® contacts
- Assembly of the ID module to the device by means of a Han® industrial connector

Technical characteristics

Inserts

Supply voltage	24 V via digital I/O device Han E® module (see page 06.42)
Electrical connector, 24 V	
Memory capacity	max. 128 Byte
Material	polycarbonate
Working temperature	0 °C ... +70 °C
Stock temperature	0 °C ... +85 °C
Max. length recommended between I/O device and ID module	100 m *

Han
Modular

General description

The HARTING connector identification module (ID module) is suitable for storing of data and for coding of connectors. It is integrated in a Han-Modular® standard E module.

The module can be connected to a 24 V digital I/O device of a PLC. Two digital inputs are used for detecting the module connection and the data input. Two digital outputs are used for the data output and the system clock. Furthermore the ID module must be connected with 24 V and GND. Communication is carried out with voltage levels of 24 V according to the I²C bus standard. The total memory capacity is 128 Byte, e.g. for storing part numbers to identify the module. It is also possible to store the start parameters or operating data for machine components.

A typical data structure is displayed in the following table:

Byte no.

16	15	14	13	12	11	10	9	8	7	6	5	4	3	2	1
Check sum		Operating hours of tool				Start parameter of the unit				Part number of the unit					

Applications for the ID module can be found in modular machines and product lines. A great advantage of the ID module is the non volatile decentralized storing of e.g. operating data. When changing the location stored data can protect the machines from damages. In service cases of the equipment data can be analyzed to minimize service time.



Input module

Identification	Part number Male insert (M)	Drawing	Dimensions in mm
Electronic identification module	20 70 001 1001		





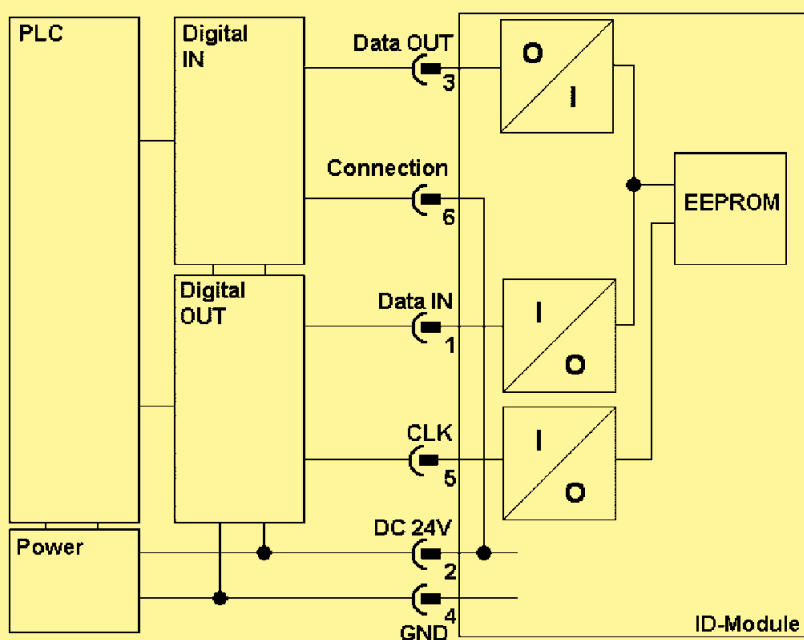

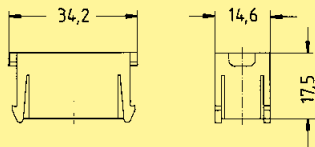

Han
Modular

Block diagram / Wiring plan

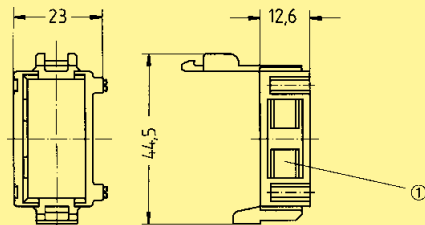

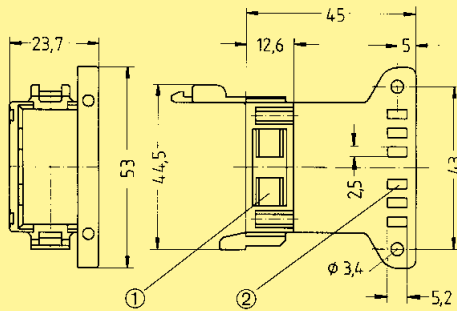
Meaning of the connections

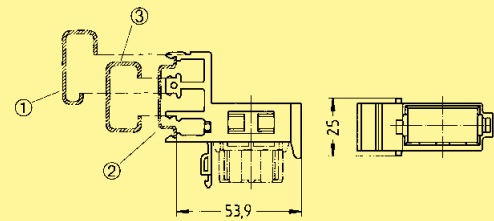
Pin no.	Name	Meaning/Function
1	Data IN	Input for data and control signals from PLC
2	DC 24 V	Power connection of the ID module
3	Data OUT	Output for data signals from ID module to PLC
4	GND	Ground
5	CLK	System clock for synchronisation
6	Connection	Output of the ID module for connection detection

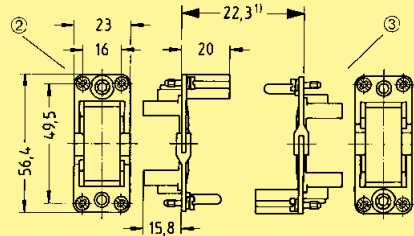
Identification	Part number	Drawing	Dimensions in mm
<p>Han-Modular® Dummy module to fill up module spaces not in use in the frame</p> 	<p>09 14 000 9950</p>		
<p>Module clamp without strain relief *</p>  <p>Delivery comprises one module clamp.</p>	<p>09 14 000 0311</p>	 <p>1 Slot for identification strip</p>	
<p>Module clamp with strain relief *</p>  <p>Delivery comprises one module clamp.</p>	<p>09 14 000 0312</p>	 <p>1 Slot for identification strip 2 For cable ties with max. 5 mm width</p>	
<p>Module clamp for rail *</p>  <p>Delivery comprises one module clamp.</p>	<p>09 14 000 0313</p>	 <p>1 G-rail DIN EN 60 715-G32 2 rail DIN EN 60 715-35 x 7.5 with 1 mm thickness or -35 x 15 with 1.5 mm thickness 3 C-rail DIN EN 60 715-C30</p>	
<p>Frame for 1 module</p>  <p>in housing Han® 10 A</p>	<p>09 14 000 0304</p>	 <p>1 Distance max. 23.5 mm 2 Hoods 3 Housings</p>	

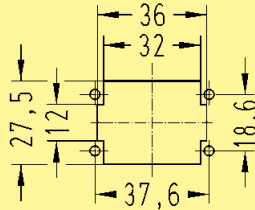
Identification	Part number	Drawing	Dimensions in mm
<p>Fixing bracket for Han-Modular® Compact</p> 	<p>09 14 000 9947</p>	 <p>1 Panel cut out</p>	

Han
Modular

Han
Modular