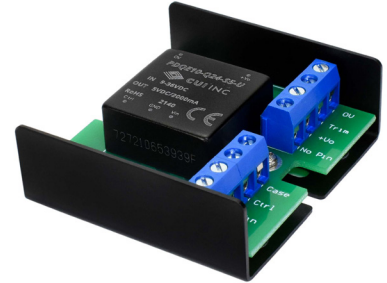

**SERIES: PDQE10-U | DESCRIPTION: DC-DC CONVERTER**
**FEATURES**

- up to 10 W isolated output
- 1,500 Vdc isolation
- ultra-wide 4:1 input range (9~36 Vdc, 18~75 Vdc)
- same side input/output connections
- single/dual regulated outputs
- input under-voltage, output short-circuit, over-current, & over-voltage protections
- wide operating temperature range (-40~85°C)
- efficiency up to 88%
- EN 62368-1
- meets UL 62368

**MODEL**

MODEL	input voltage		output voltage (Vdc)	output current		output power max (W)	ripple & noise <sup>1</sup> max (mVp-p)	efficiency <sup>2</sup> typ (%)
	typ (Vdc)	range (Vdc)		min (mA)	max (mA)			
PDQE10-Q24-D5-U	24	9~36	±5	0	±1000	10	80	83
PDQE10-Q24-D9-U	24	9~36	±9	0	±555	10	80	86
PDQE10-Q24-D12-U	24	9~36	±12	0	±416	10	80	87
PDQE10-Q24-D15-U	24	9~36	±15	0	±333	10	80	87
PDQE10-Q24-D24-U	24	9~36	±24	0	±208	10	80	87
PDQE10-Q24-S3-U	24	9~36	3.3	0	2400	7.9	80	78
PDQE10-Q24-S5-U	24	9~36	5	0	2000	10	80	83
PDQE10-Q24-S9-U	24	9~36	9	0	1111	10	80	85
PDQE10-Q24-S12-U	24	9~36	12	0	833	10	80	86
PDQE10-Q24-S15-U	24	9~36	15	0	667	10	80	86
PDQE10-Q24-S24-U	24	9~36	24	0	416	10	80	88
PDQE10-Q48-D5-U	48	18~75	±5	0	±1000	10	80	83
PDQE10-Q48-D12-U	48	18~75	±12	0	±416	10	80	87
PDQE10-Q48-D15-U	48	18~75	±15	0	±333	10	80	87
PDQE10-Q48-D24-U	48	18~75	±24	0	±208	10	80	87
PDQE10-Q48-S3-U	48	18~75	3.3	0	2400	7.9	80	79
PDQE10-Q48-S5-U	48	18~75	5	0	2000	10	80	83
PDQE10-Q48-S12-U	48	18~75	12	0	833	10	80	87
PDQE10-Q48-S15-U	48	18~75	15	0	667	10	80	87
PDQE10-Q48-S24-U	48	18~75	24	0	416	10	80	88

- Notes:
1. From 5~100% load, 20 MHz bandwidth oscilloscope, using the "parallel cable" method for testing.  
From 0~5% load, ripple and noise is <±5% Vo.
  2. Measured at nominal input voltage and rated load.
  3. All specifications are measured at Ta=25°C, humidity < 75%, nominal input voltage, and rated output load unless otherwise specified.

## PART NUMBER KEY

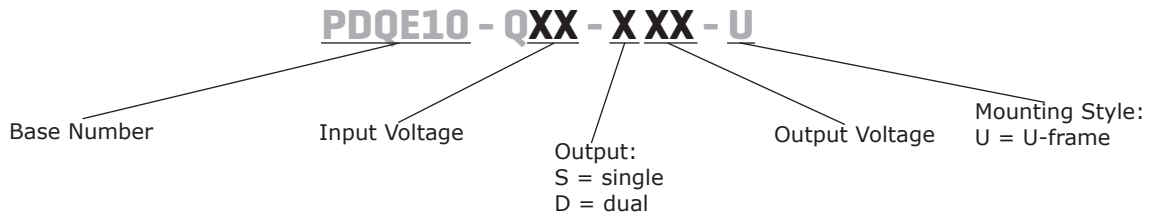

## INPUT

parameter	conditions/description	min	typ	max	units	
operating input voltage	24 Vdc input models	9	24	36	Vdc	
	48 Vdc input models	18	48	75	Vdc	
start-up voltage	24 Vdc input models			9	Vdc	
	48 Vdc input models			18	Vdc	
surge voltage	for maximum of 1 second					
	24 Vdc input models	-0.7		50	Vdc	
	48 Vdc input models	-0.7		100	Vdc	
under voltage shutdown	24 Vdc input models	5.5	6.5		Vdc	
	48 Vdc input models	12	15.5		Vdc	
current (full load/no load)	24 Vdc input models		3.3 Vdc output models all other models	423/5 502/5	434/12 514/12	mA mA
	48 Vdc input models		3.3 Vdc output models all other models	190/4 251/4	215/8 258/8	mA mA
remote on/off (CTRL)	module ON (3.5~12 Vdc or CTRL pin open circuit or pulled high) module OFF (0~1.2 Vdc CTRL pin pulled low to GND) input current when switched off		6	10	mA	
start-up time	nominal input, constant resistance load		10		ms	
filter	Pi filter					
no load power consumption			0.12		W	

## OUTPUT

parameter	conditions/description	min	typ	max	units
maximum capacitive load <sup>4</sup>	3.3, 5 Vdc output models			2,200	μF
	±5 Vdc output models			1,000	μF
	9, ±9 Vdc output models			680	μF
	12, ±12 Vdc output models			470	μF
	15, ±15 Vdc output models			330	μF
	24, ±24 Vdc output models			100	μF
voltage accuracy <sup>5</sup>	0% to full load		±1	±3	%
line regulation	from low line to high line, full load				
	positive outputs		±0.2	±0.5	%
	negative outputs		±0.5	±1	%
load regulation <sup>6</sup>	from 5% to full load				
	positive outputs		±0.5	±1	%
	negative outputs		±0.5	±1.5	%

**OUTPUT (CONTINUED)**

parameter	conditions/description	min	typ	max	units
cross regulation	dual output models: positive output 50% load secondary output from 10~100% load			±5	%
switching frequency <sup>7</sup>	PWM mode		350		kHz
transient recovery time	25% load step change, nominal input voltage		300	500	µs
transient response deviation	25% load step change, nominal input voltage		±3	±5	%
temperature coefficient	at full load			±0.03	%/°C

Note:  
 4. Specified maximum capacitive load for positive and negative outputs is identical.  
 5. Output voltage accuracy of ±5 Vdc/±9 Vdc output converter for 0%~5% load is ±5% max.  
 6. Load regulation for 0%~100% load is ±5%.  
 7. Switching frequency is measured at full load. Module reduces switching frequency at light load (below 50%), to increase efficiency.

**PROTECTIONS**

parameter	conditions/description	min	typ	max	units
over voltage protection		110		160	%
over current protection		110	140	190	%
short circuit protection	continuous, auto recovery				

**SAFETY AND COMPLIANCE**

parameter	conditions/description	min	typ	max	units
isolation voltage	input to output for 1 minute at 1 mA	1,500			Vdc
isolation resistance	input to output at 500 Vdc	1,000			MΩ
isolation capacitance	input to output, 100 kHz / 0.1 V		1,000		pF
safety approvals	certified to 62368: EN, IEC				
conducted emissions	CISPR32/EN55032 CLASS A (without extra components), CLASS B (see Fig. 3-2) EN50121-3-2 150kHz-500kHz 99dBuV (see Fig. 3-2) EN55016-2-1 500kHz-30MHz 93dBuV (see Fig. 3-2)				
radiated emissions	CISPR32/EN55032 CLASS A (without extra components), CLASS B (see Fig. 3-2) EN50121-3-2 30MHz-230MHz 40dBuV/m at 10m (see Fig. 3-2) EN55016-2-1 230MHz-1GHz 47dBuV/m at 10m (see Fig. 3-2)				
ESD	IEC/EN61000-4-2 Contact ±4kV perf. Criteria B EN50121-3-2 Contact ±6kV/Air ±8kV perf. Criteria A				
radiated immunity	IEC/EN61000-4-3 10V/m perf. Criteria A EN50121-3-2 20V/m perf. Criteria A				
EFT/burst	IEC/EN61000-4-4 ±2kV perf. Criteria B EN50121-3-2 ±2kV 5/50ns 5kHz (see Fig. 3-1) perf. Criteria A				
surge	IEC/EN61000-4-5 line to line ±2kV (see Fig. 3-1) perf. Criteria B EN50121-3-2 line to line ±1kV (42Ω, 0.5µF) (see Fig. 3-1) perf. Criteria A				
conducted immunity	IEC/EN61000-4-6 3 Vr.m.s perf. Criteria A EN50121-3-2 0.15MHz-80MHz 10V r.m.s perf. Criteria A				
voltage dips & interruptions	IEC/EN61000-4-29 0%, 70% perf. Criteria B				
MTBF	as per MIL-HDBK-217F, 25°C	1,000,000			hours
RoHS	yes				

## ENVIRONMENTAL

parameter	conditions/description	min	typ	max	units
operating temperature	see derating curve	-40		85	°C
storage temperature		-55		125	°C
storage humidity	non-condensing	5		95	%

## DERATING CURVES

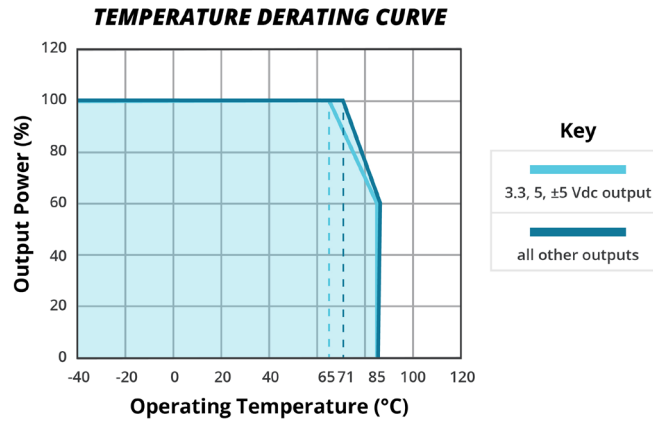

## SOLDERABILITY

parameter	conditions/description	min	typ	max	units
pin soldering resistance temperature	1.5 mm from case for 10 seconds			300	°C

## MECHANICAL

parameter	conditions/description	min	typ	max	units
dimensions	55.00 x 52.30 x 19.00 [2.165 x 2.059 x 0.748 inch]				mm
case material	aluminum alloy				
weight			44		g

## MECHANICAL DRAWING

units: mm [inch]  
 wire range: 24-12 AWG  
 tolerance:  $\pm 1.00[\pm 0.039]$   
 tightening torque: Max 0.4 N·m

PIN CONNECTIONS		
PIN	Function	
	Single	Dual
1	GND	GND
2	Vin	Vin
3	Ctrl	Ctrl
4	Case	Case
5	NC	NC
6	+Vo	+Vo
7	NC	0V
8	0V	-Vo

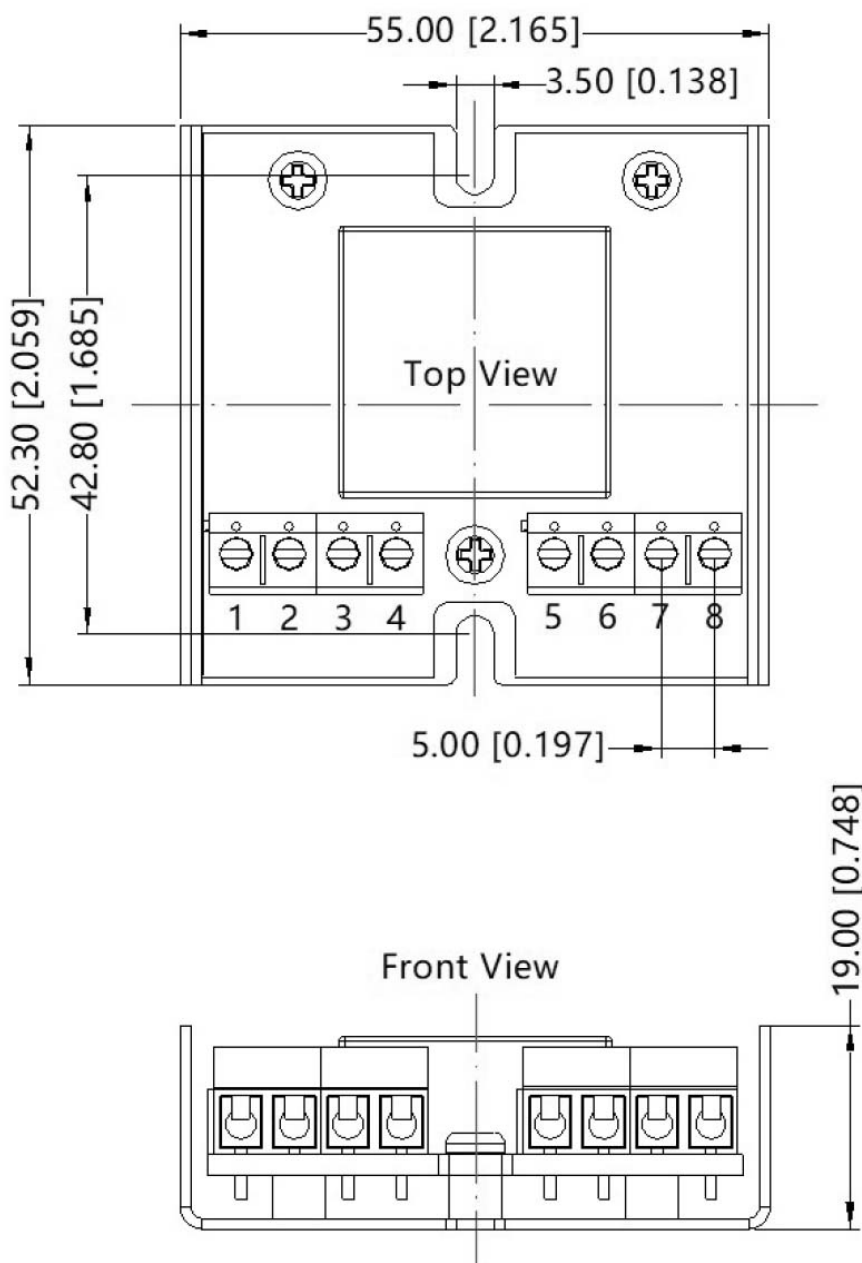

## EFFICIENCY CURVES

**EFFICIENCY VS INPUT VOLTAGE**  
**PDQE10-Q48-D15-U**  
*(full load)*

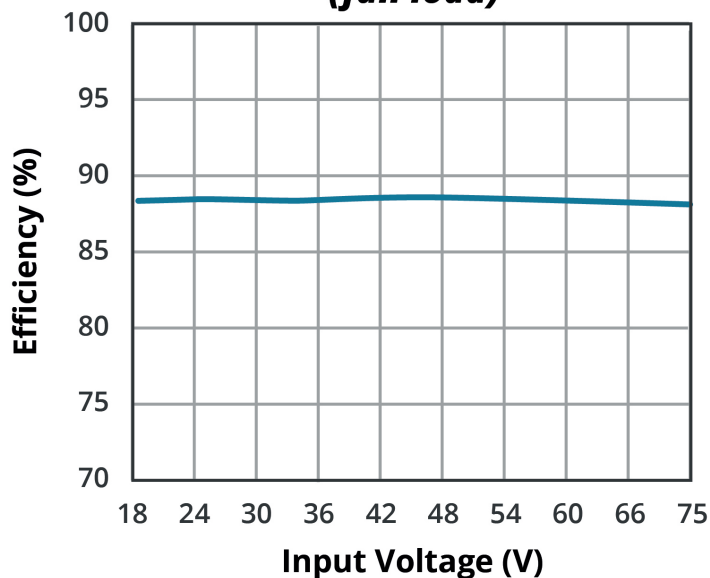

**EFFICIENCY VS OUTPUT LOAD**  
**PDQE10-Q48-D15-U**  
*(Vin = 48V)*

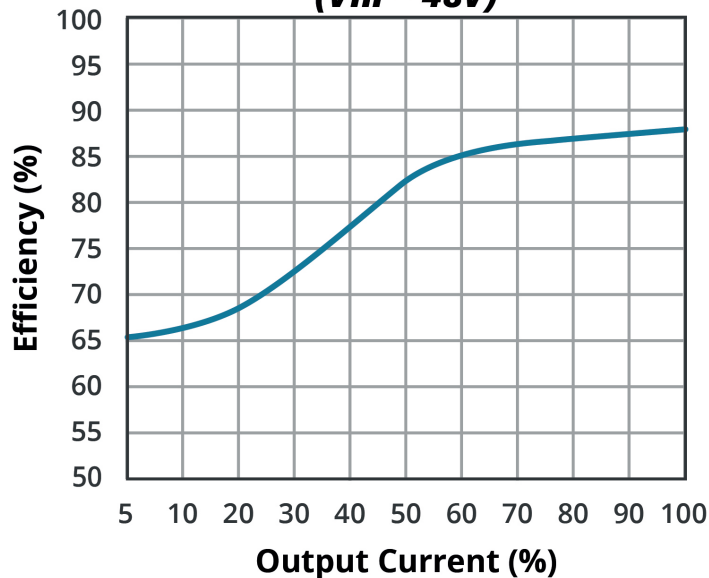

**EFFICIENCY VS INPUT VOLTAGE**  
**PDQE10-Q24-S5-U**  
*(full load)*

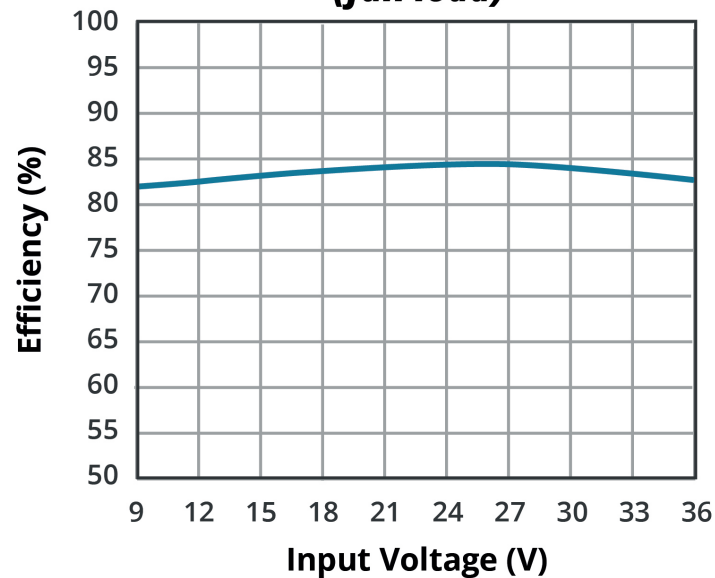

**EFFICIENCY VS OUTPUT LOAD**  
**PDQE10-Q24-S5-U**  
*(Vin = 24V)*

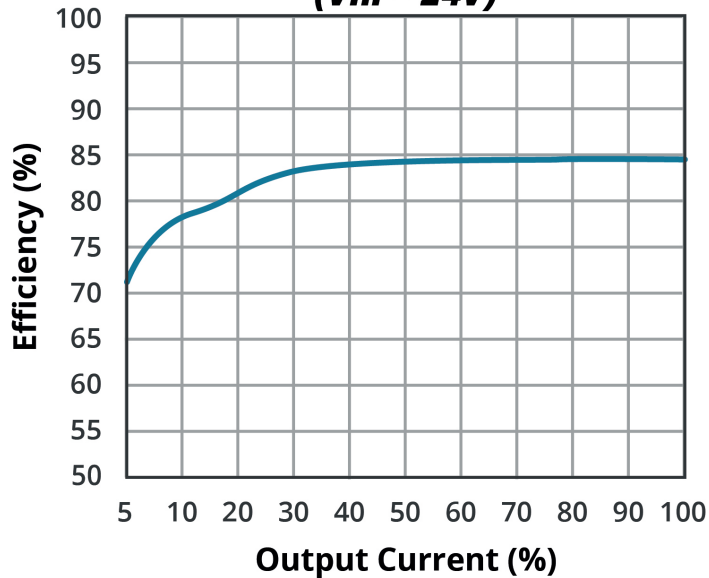

## APPLICATION CIRCUIT

This series has been tested according to the following recommended circuits (Figures 1 & 2) before leaving the factory. If you want to further reduce the input and output ripple, you can increase the input and output capacitors or select capacitors of low equivalent series resistance (ESR) provided that the capacitance is less than the maximum capacitive load of the model.

**Figure 1**  
Single Output Models

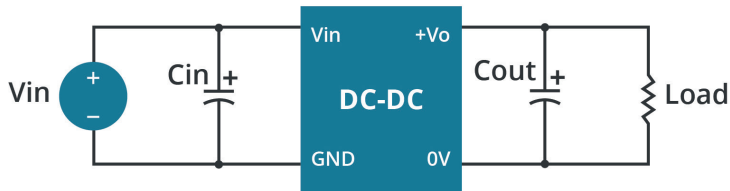

**Figure 2**  
Dual Output Models

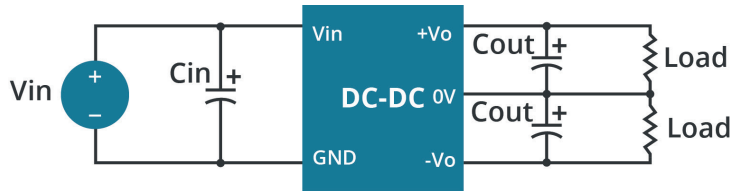
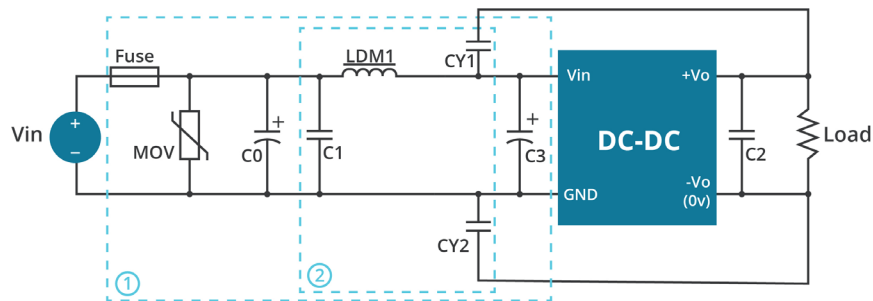

**Table 1**

Vin (Vdc)	Cin (μF/V)	Vout (Vdc)	Cout (μF/V)
24	100/50	±5/±9/3.3/5/9	10/16
		±12/±15/12/15	10/25
		±24/24	10/50
48	10~47/100	±5/3.3/5	10/16
		±12/±15/12/15	10/25
		±24/24	10/50

## EMC RECOMMENDED CIRCUIT

**Figure 3**



**Table 2**

Recommended External Circuit Components		
Vin (Vdc)	24	48
FUSE	choose according to actual input current	
MOV	S20K30	S14K60
C0/C3	330μF / 50V	330μF / 100V
C1	1μF / 50V	1μF / 100V
C2	refer to the Cout in Figure 1 & 2	
LDM1	4.7μH	
CY1, CY2	1nF / 2kV	

## REVISION HISTORY

---

rev.	description	date
1.0	initial release	12/07/2021

The revision history provided is for informational purposes only and is believed to be accurate.



**CUI INC**  
a bel group

**Headquarters**  
20050 SW 112th Ave.  
Tualatin, OR 97062  
**800.275.4899**

Fax 503.612.2383  
**cui.com**  
techsupport@cui.com

CUI offers a two (2) year limited warranty. Complete warranty information is listed on our website.

CUI reserves the right to make changes to the product at any time without notice. Information provided by CUI is believed to be accurate and reliable. However, no responsibility is assumed by CUI for its use, nor for any infringements of patents or other rights of third parties which may result from its use.

CUI products are not authorized or warranted for use as critical components in equipment that requires an extremely high level of reliability. A critical component is any component of a life support device or system whose failure to perform can be reasonably expected to cause the failure of the life support device or system, or to affect its safety or effectiveness.