

Low Profile, High Current IHLP® Inductors

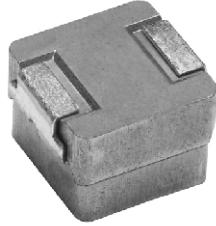

Manufactured under one or more of the following:
US Patents; 6,198,375/6,204,744/6,449,829/6,460,244.
 Several foreign patents, and other patents pending.

STANDARD ELECTRICAL SPECIFICATIONS				
L ₀ INDUCTANCE ± 20 % AT 100 kHz, 0.25 V, 0 A (μH)	DCR TYP. 25 °C (mΩ)	DCR MAX. 25 °C (mΩ)	HEAT RATING CURRENT DC TYP. (A) ⁽³⁾	SATURATION CURRENT DC TYP. (A) ⁽⁴⁾
0.56	3.4	3.6	20	12
0.68	4.2	4.5	18	11.5
0.82	4.6	4.9	16.5	13
1.0	5.6	6.5	13	15
1.5	8.6	9.0	12	12
2.2	13.0	13.6	10	10
3.3	19.9	20.9	8	8
4.7	28.9	30.3	6.5	7
5.6	32.7	34.4	6	7
6.8	42.5	44.6	5.5	5.5
8.2	48.3	50.7	5.0	5.0
10.0	67.9	71.3	4.5	4.5

Notes

- (1) All test data is referenced to 25 °C ambient
- (2) Operating temperature range - 55 °C to + 125 °C
- (3) DC current (A) that will cause an approximate ΔT of 40 °C
- (4) DC current (A) that will cause L₀ to drop approximately 20 %
- (5) The part temperature (ambient + temp rise) should not exceed 125 °C under worst case operating conditions. Circuit design, component placement, PWB trace size and thickness, airflow and other cooling provisions all affect the part temperature. Part temperature should be verified in the end application.

FEATURES

- Shielded construction
- Frequency range below 1.0 MHz
- Lowest DCR/μH, in this package size
- Powdered iron composition provides soft saturation
- Handles high transient current spikes without saturation
- Saturation and inductance extremely stable over temperature
- Ultra low buzz noise, due to composite construction
- Compliant to RoHS directive 2002/95/EC

RoHS
 COMPLIANT

APPLICATIONS

- Notebook/desktop/server applications
- High current POL converters
- Low profile, high current power supplies
- DC/DC converters in distributed power systems
- DC/DC converter for Field Programmable Gate Array (FPGA)

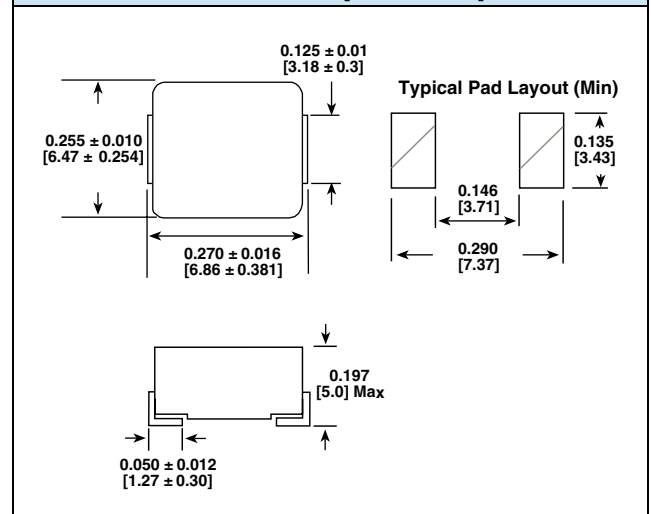
DIMENSIONS in inches [millimeters]

DESCRIPTION

IHLP-2525EZ-01	1.0 μH	± 20 %	ER	e3
MODEL	INDUCTANCE VALUE	INDUCTANCE TOLERANCE	PACKAGE CODE	JEDEC LEAD (Pb)-FREE STANDARD

GLOBAL PART NUMBER

I	H	L	P	2	5	2	5	E	Z	E	R	1	R	0	M	0	1
PRODUCT FAMILY				SIZE				PACKAGE CODE		INDUCTANCE VALUE		TOL.	SERIES				

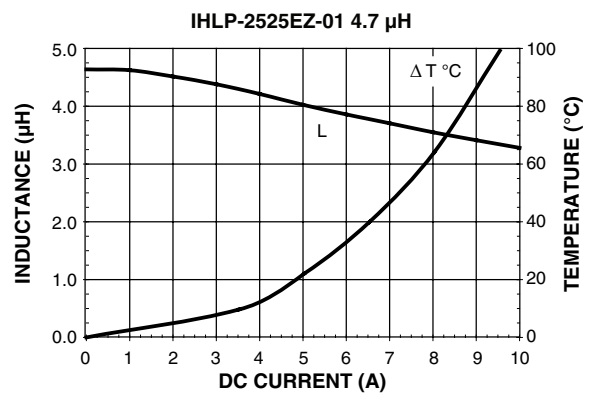
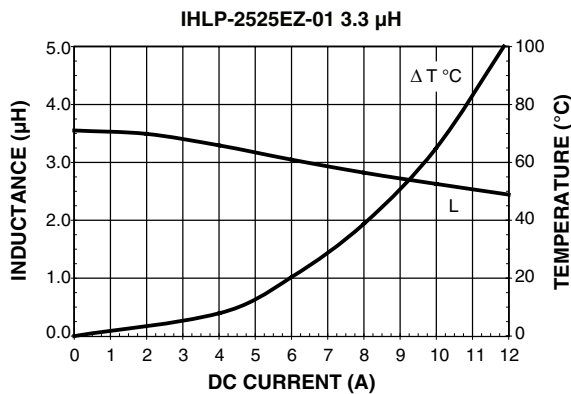
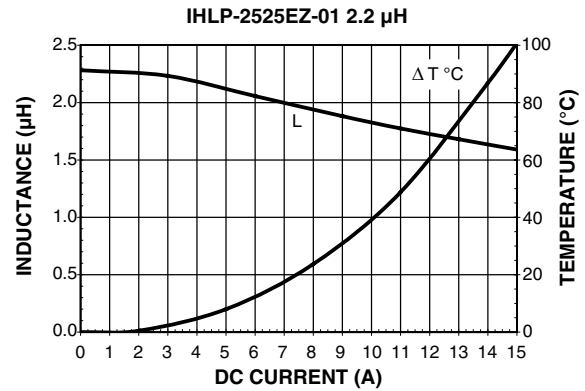
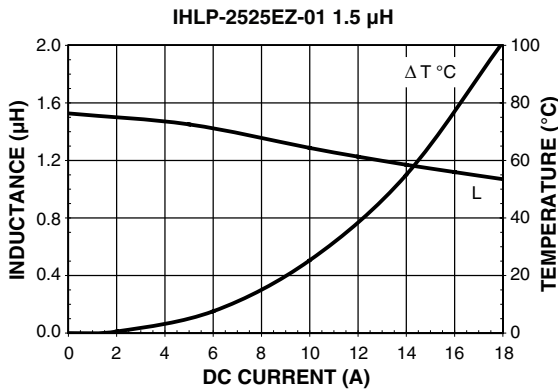
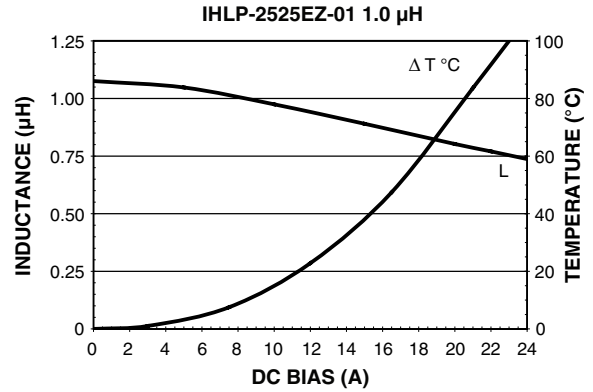
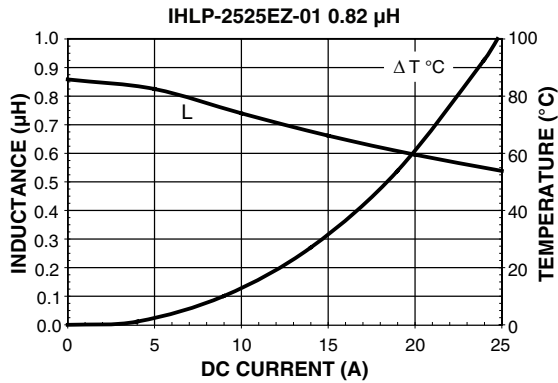
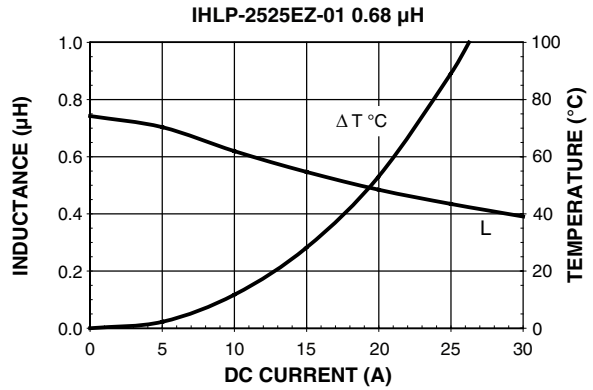
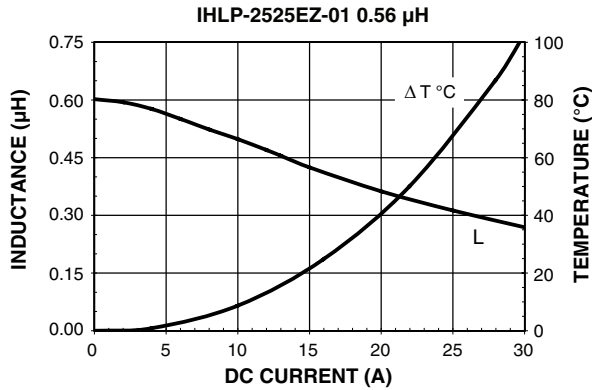
PERFORMANCE GRAPHS





PERFORMANCE GRAPHS

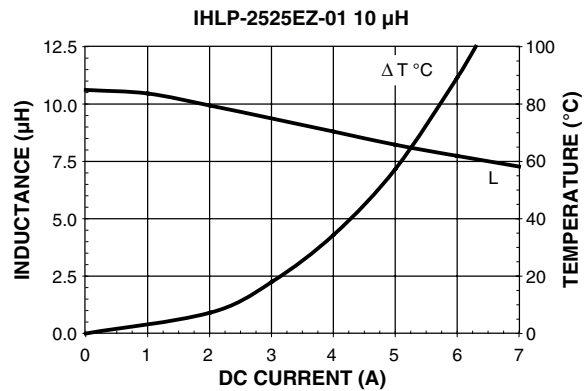
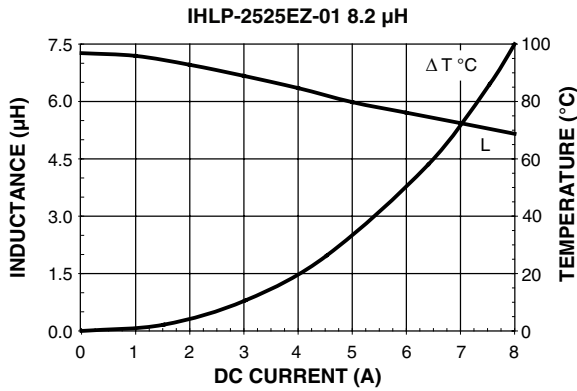
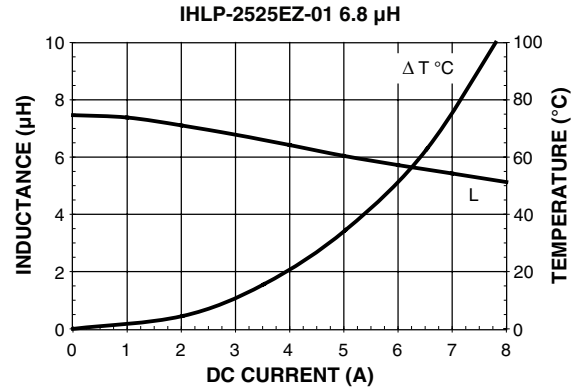
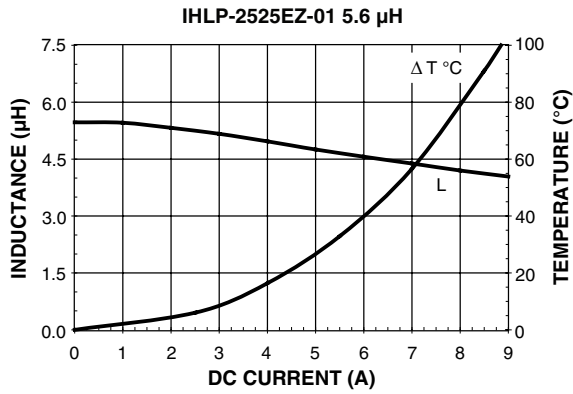



Disclaimer

All product specifications and data are subject to change without notice.

Vishay Intertechnology, Inc., its affiliates, agents, and employees, and all persons acting on its or their behalf (collectively, "Vishay"), disclaim any and all liability for any errors, inaccuracies or incompleteness contained herein or in any other disclosure relating to any product.

Vishay disclaims any and all liability arising out of the use or application of any product described herein or of any information provided herein to the maximum extent permitted by law. The product specifications do not expand or otherwise modify Vishay's terms and conditions of purchase, including but not limited to the warranty expressed therein, which apply to these products.

No license, express or implied, by estoppel or otherwise, to any intellectual property rights is granted by this document or by any conduct of Vishay.

The products shown herein are not designed for use in medical, life-saving, or life-sustaining applications unless otherwise expressly indicated. Customers using or selling Vishay products not expressly indicated for use in such applications do so entirely at their own risk and agree to fully indemnify Vishay for any damages arising or resulting from such use or sale. Please contact authorized Vishay personnel to obtain written terms and conditions regarding products designed for such applications.

Product names and markings noted herein may be trademarks of their respective owners.