

DIRIS A-30/A-41

Multifunction measuring unit - PMD

measurement and advanced monitoring - door mounting



DIRIS A-30

The solution for

- > Industry
- > Building
- > Infrastructures



Strong points

- > User-friendly operation
- > Detects wiring errors
- > Customisable
- > Compliant with IEC 61557-12

Compliance with standards

- > IEC 61557-12
- > IEC 62053-22 class 0.5 S
- > IEC 62053-23 class 2
- > UL



Function

The DIRIS A-30 and A-41 are power monitoring devices that provide the user with all of the measurements needed to complete energy efficiency projects and to assure the monitoring of electrical distribution.

All the information can be used and analysed remotely using energy efficiency software packages.

Advantages

User-friendly operation

With its large backlit multiple-display screen with 6 hot keys, the DIRIS A-30 is easy to use.

Detects wiring errors

The DIRIS A-30 is provided with a correction function for TC wiring errors.

Customisable

The DIRIS A-30 can be equipped with additional modules that give the user flexibility throughout the service life of the product. Communication modules and additional digital or analogue inputs/outputs can be used to increase its range of functionality.

Functional diagram

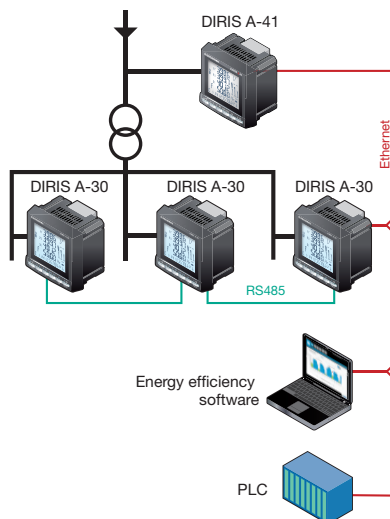

Compliant with IEC 61557-12

Reference standard for PMDs (Performance metering & monitoring devices), IEC 61557-12 guarantees performance levels and satisfactory performance from the PMDs under the environmental conditions typical of industrial and tertiary applications.

Functions

Multi-measurement

- Currents
 - instantaneous: I1, I2, I3, In, Isystem
 - average/max average: I1, I2, I3, In
- Voltages & frequency
 - instantaneous: V1, V2, V3, U12, U23, U31, F, Vsystem, Ussystem
 - average/max average: V1, V2, V3, U12, U23, U31, F
- Powers
 - instantaneous: 3P, ΣP, 3Q, ΣQ, 3S, ΣS
 - max average: ΣP, ΣQ, ΣS
 - predictive: (ΣP), (ΣQ), (ΣS)
- Power factors
 - instantaneous: 3PF, ΣPF
 - average/max average: ΣPF

- Kfactor
- Temperatures⁽¹⁾
 - internal
 - external via 3 PT100 probes

Metering

- Active energy: +/- kWh
- Reactive energy: +/- kvarh
- Effective power: kVAh
- Hours: ⌚

Harmonic analysis

- Level of harmonic distortion
 - Currents: thd I1, thd I2, thd I3, thd In
 - Phase-to-neutral voltage: thd V1, thd V2, thd V3
 - Phase-to-phase voltage: thd U12, thd U23, thd U31

- Individual harmonics up to 63rd
 - Currents: HI1, HI2, HI3, HIn
 - Phase-to-neutral voltage: HV1, HV2, HV3,
 - Phase-to-phase voltages: HU12, HU23, HU31

Load curve⁽¹⁾

- Active & reactive power: ΣP+/-; ΣQ+/-
- Voltages & frequency: V1, V2, V3, U12, U23, U31, F

Events⁽¹⁾

- Alarms on all electrical parameters.

Communications⁽¹⁾

- RS485 (Modbus)
- Ethernet (Modbus/TCP or Modbus RTU)
- Ethernet with RS485 Modbus RTU gateway over TCP
- Profibus DP Sub-D9

Inputs/Outputs⁽¹⁾

- Pulse counting
- Checking / control of equipment
- Alarm report
- Pulse report

Analogue output

- Analogue 0/4- 20 mA

⁽¹⁾ Available as an option (see following pages).

Front panel



1. Backlit LCD display
2. Pushbutton for currents and for connection correction function
3. Pushbutton for voltages and frequency..
4. Pushbutton for active, reactive and effective powers and for power factor.
5. Pushbutton for maximum and average values for currents and power levels.
6. Pushbutton for harmonics.
7. Pushbutton for electrical energy meters, timers and impulse counters

Plug-in modules

DIRIS® A-30



diris_773_a

DIRIS® A-41*



diris_774_a

* With current measurement module for Neutral as standard.



Pulse outputs

2 configurable pulse outputs (type, weight and run) on \pm kWh, \pm kvarh and kVAh.



MODBUS® communication

RS485 link with MODBUS® protocol (speed up to 38400 baud).



PROFIBUS® DP communication

SUB-D9 link with PROFIBUS® DP protocol (speed up to 12 Mbaud).



Analogue outputs

You can connect a maximum of 2 modules, i.e. 4 analogue outputs.
2 outputs can be allocated to:
3I, In, 3V, 3U, F, \pm Σ P, \pm Σ Q, Σ S, Σ PFL/C, Isys, Vsys, Usys, Ppred, Qpred, Spred, T°C internal, T°C 1, T°C 2, T°C3 and to 30 VDC power supply.



2 inputs - 2 outputs

You can connect a maximum of 3 modules, i.e. 6 inputs / 6 outputs.
2 outputs can be allocated to:
- monitoring: 3I, In, 3V, 3U, F, \pm Σ P, \pm Σ Q, Σ S, Σ PFL/C, THD 3I, THD In, THD 3V, THD 3U, Ppred, Qpred, Spred, T°C internal, T°C 1, T°C2, T°C3 and of time counter,
- remote control,
- timed remote control,
- 2 inputs for pulse counting.



Storage capability

- Memory function up to max. 62 days for P+, P-, Q+, Q- with a TOP for internal or external synchronisation of 5, 8, 10, 15, 20, 30 and 60 minutes.
- Memory function for the last 10 timed and dated alarms.
- Memory function for the last min and max instantaneous values for 3U, 3V, 3I, In, F, Σ P \pm , Σ Q \pm , Σ S, THD 3U, THD 3V, THD, 3U, THD, 3V, THD, 3I, THD In.
- Memory function of average values 3U, 3V et F as a function of synchronisation (maximum 60 days).



Ethernet communication

- Ethernet link with MODBUS/TCP or MODBUS RTU over TCP.



Ethernet communication with RS485 MODBUS gateway

- Ethernet link with MODBUS/TCP or MODBUS RTU over TCP.
- Connect 1 to 247 RS485 MODBUS slaves.

DIRIS A-30/A-41

Multifunction measuring unit - PMD

measurement and advanced monitoring - door mounting

Accessories

Current transformer

See "Current transformers" pages.

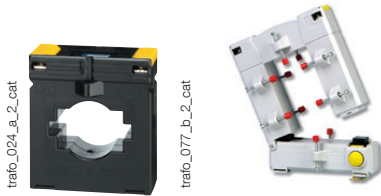

IP65 protection



Terminals

DIRIS A-30

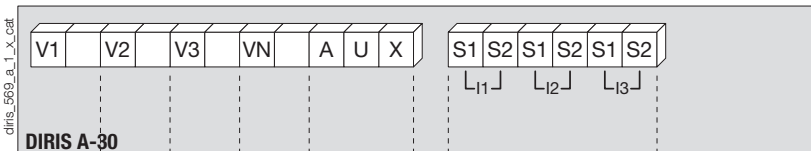

S1 - S2: current inputs

AUX: auxiliary power supplies U_s
V1 - V2 - V3 - VN: voltage inputs

DIRIS A-41

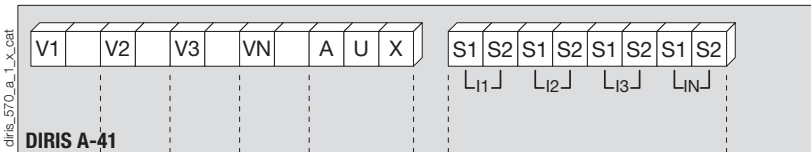

S1 - S2: current inputs

AUX: auxiliary power supplies U_s
V1 - V2 - V3 - VN: voltage inputs

Communication module

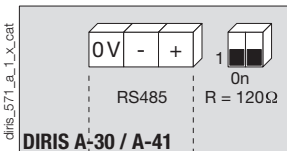

RS485 link.

R = 120 Ω : internal resistance for the RS485 link.

Pulse output module

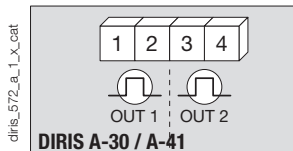

1 - 2: pulse output n°1.

3 - 4: relay output n°2.

Analogue output module

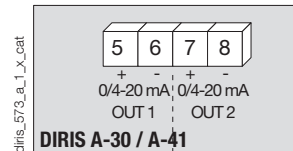

5 - 6: analogue output n°1.

7 - 8: analogue output n°2.

2 input / 2 output module

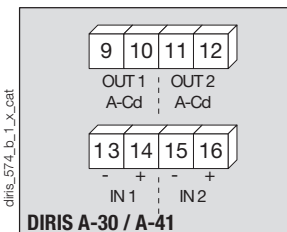

9 - 10: relay output n°1.

11 - 12: relay output n°2.

13 - 14: optical input n°1.

15 - 16: optical input n°2.

Memory module

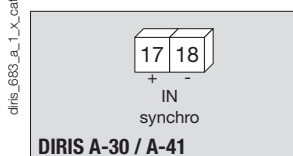

17 - 18: synchronisation input.

Temperature module

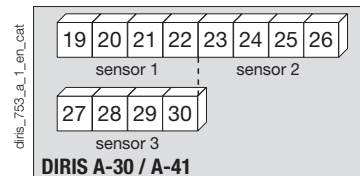

Probe 1	Probe 2	Probe 3
19: red	23: red	27: red
20: red	24: red	28: red
21: white	25: white	29: white
22: white	26: white	30: white

Ethernet module

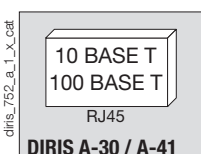

Ethernet module + RS485 MODBUS gateway

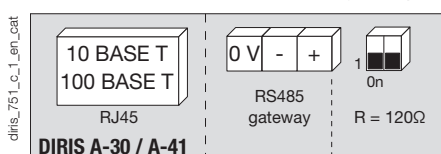

Electrical characteristics

Measurement of currents on insulated inputs (TRMS)	
Via CT primary	9,999 A
Via CT secondary	1 or 5 A
Measurement range	0 ... 11 kA
Input consumption	≤ 0,1 VA
Measurement updating period	1 s
Accuracy	0.2%
Permanent overload	6 A
Intermittent overload	10 I _n for 1 s
Voltage measurements (TRMS)	
Direct measurement between phases	50 to 1039 VAC
Direct measurement between phase and neutral	28 to 600 VAC
VT primary measurement	500,000 VAC
VT secondary measurement	60, 100, 110, 173, 190 VAC
Frequency	50 / 60 Hz
Input consumption	≤ 0,1 VA
Measurement updating period	1 s
Accuracy	0.2%
Current - voltage product	
Limitation for TC 1 A	10,000,000
Limitation for TC 5 A	10,000,000
Power measurement	
Measurement updating period	1 s
Accuracy	0.5%
Power factor measurement	
Measurement updating period	1 s
Accuracy	0.5%
Frequency measurement	
Measurement range	45 ... 65 Hz
Measurement updating period	1 s
Accuracy	0.1%
Energy accuracy	
Active (according to IEC 62053-22)	Class 0.5 S
Reactive (according to IEC 62053-23)	Class 2
Auxiliary power supply	
Alternative voltage	110 ... 400 VAC
AC tolerance	± 10 %
Direct current	120 ... 350 VDC / 12 ... 48 VDC
DC tolerance	± 20 % / - 6 ... + 20 %
Frequency	50 / 60 Hz
Power consumption	≤ 10 VA

Module 2 inputs - 2 outputs: outputs (alarms / control)	
Number of relays	2 ⁽¹⁾
Type	250 VAC - 5 A - 1150 VA
Module 2 inputs - 2 outputs: optical coupler inputs	
Number	2 ⁽¹⁾
Power supply	10 ... 30 VDC
Minimum width of signal	10 ms
Minimum length between 2 pulses	18 ms
Type	Optical couplers
Pulse output module	
Number of relays	2
Type	100 VDC - 0.5 A - 10 VA
Max. number of manoeuvres	≤ 10 ⁸
Analogue output module	
Number of outputs	2 ⁽²⁾
Type	Insulated
Scale	0 / 4 ... 20 mA
Load resistance	600 Ω
Maximum current	30 mA
MODBUS communication module	
Link	RS485
Type	2 to 3 half duplex wires
Protocol	MODBUS [®] RTU
MODBUS [®] speed	4800 to 38400 baud
PROFIBUS DP communication module	
Link	SUB-D9
Protocol	PROFIBUS [®] DP
PROFIBUS [®] speed	9.8 kbaud ... 12 Mbaud
Ethernet communication module	
Connection technology	RJ45
Baud rate	10 base T / 100 base T
Protocol	MODBUS TCP or MODBUS RTU on TCP
Temperature module (inputs)	
Type	PT100
Connection	2, 3 or 4 wires
Dynamic	- 20°C ... 150°C
Accuracy	± 1 digit
Maximum length	300 cm
Operating conditions	
Operating temperature range	-10 to +55°C
Storage temperature	-20 to 85°C
Relative humidity	95%

(1) Max. 3 modules / DIRIS.

(2) Max. 2 modules / DIRIS.

Case

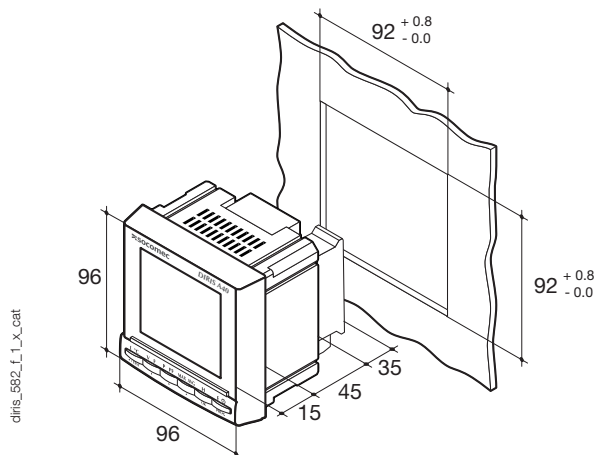

Type	Panel mounting
Dimensions W x H x D	96 x 96 x 60 mm
Case degree of protection	IP30
Front degree of protection	IP52
Display type	Backlit LCD display
Type of terminal strips	Fixed or detachable
Section of connection for voltages and other terminals	0,2 ... 2.5 mm ²
Section of connection for currents	0.5 ... 6 mm ²
Weight	400 g

DIRIS A-30/A-41

Multifunction measuring unit - PMD

measurement and advanced monitoring - door mounting

Connections

Balanced low-voltage network for DIRIS A-30

Recommendation: When disconnecting the DIRIS, the secondary of each current transformer must be short-circuited. This operation can be carried out automatically by a SOCOMEC PTI, which can be found in the SOCOMEC catalogue: please consult us. In TNC mode, it is advisable to connect the DIRIS A-30/A-41 to earth using the functional earth module.

3/4 wires with 1 CT

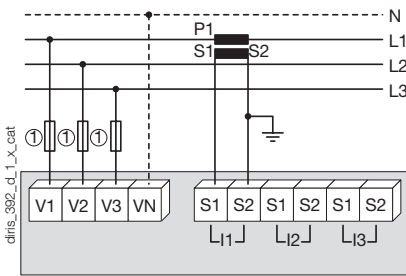

The use of 1 TC reduces by 0.5% the accuracy of the phases, the current for which is worked out by vector calculation.
1. 0.5 A gG / 0.5 A class CC fuses.

Single-phase

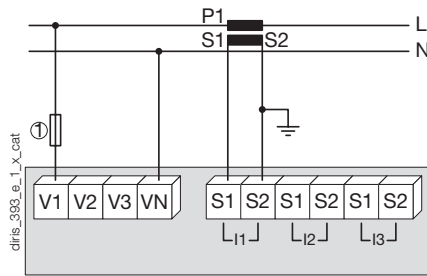

1. 0.5 A gG / 0.5 A class CC fuses.

Two-phase

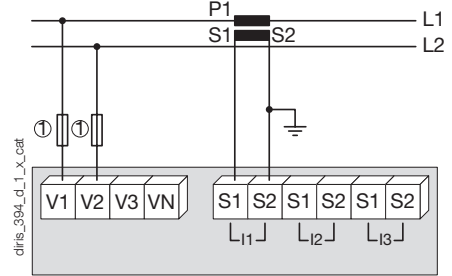

1. 0.5 A gG / 0.5 A class CC fuses.

Balanced low-voltage network for DIRIS A-30

3/4 wires with 3 CTs

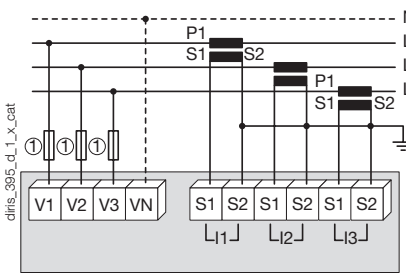

1. 0.5 A gG / 0.5 A class CC fuses.

3 wires with 2 CTs

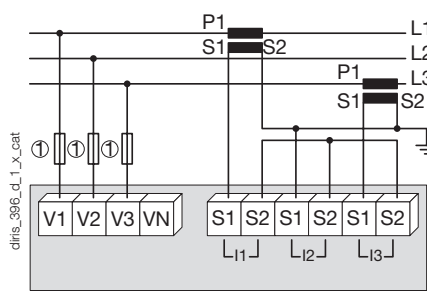

The use of 2 TC reduces by 0.5% the accuracy of the phase, the current for which is worked out by vector calculation.
1. 0.5 A gG / 0.5 A class CC fuses.

3 wires with 2 CTs

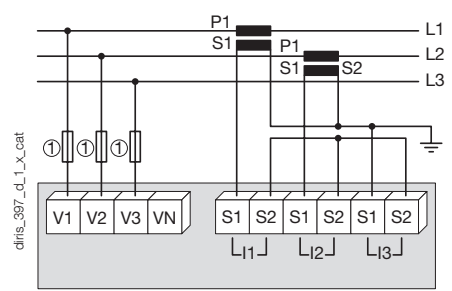

The use of 2 TC reduces by 0.5% the accuracy of the phase, the current for which is worked out by vector calculation.
1. 0.5 A gG / 0.5 A class CC fuses.

Balanced low-voltage network for DIRIS A-41

4 wires with 4 CTs

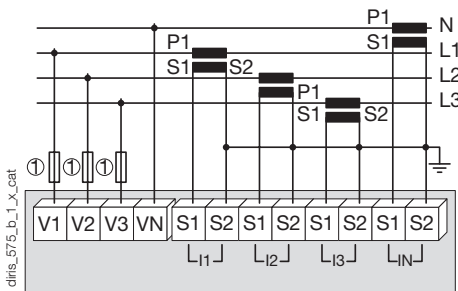

1. 0.5 A gG / 0.5 A class CC fuses.

Additional information

Communication via RS485 link

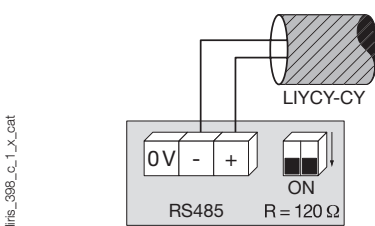

Connection of potential transformer for HV networks

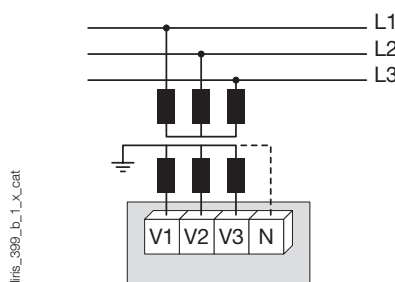

AC and DC auxiliary power supply

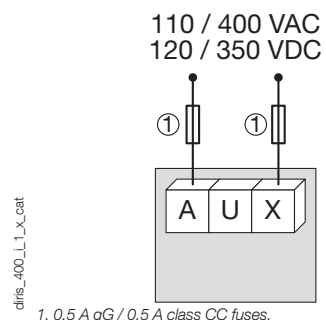

1. 0.5 A gG / 0.5 A class CC fuses.

References

Basic device	DIRIS A-30		DIRIS A-41 With CT on the neutral
Auxiliary power supply U_s	Reference		Reference
110 ... 400 VAC / 120 ... 350 VDC	4825 0403		4825 0404
12 ... 48 VDC	4825 0405		4825 0406

Options			
Plug-in modules⁽¹⁾	Reference		Reference
Pulse outputs	4825 0090		4825 0090
RS485 MODBUS [®] communication	4825 0092		4825 0092
PROFIBUS [®] DP communication	4825 0205		4825 0205
Analogue outputs	4825 0093		4825 0093
2 inputs - 2 outputs	4825 0094		4825 0094
Storage capability	4825 0097		4825 0097
Ethernet communication ⁽²⁾	4825 0203		4825 0203
Ethernet communication + RS485 gateway ⁽²⁾	4825 0204		4825 0204
Temperature inputs.	4825 0206		4825 0206

(1) Ease of integration of additional functions (maximum 4 slots on A-30 and 3 on A-41).

(2) Dimensions: 2 slots.

Accessories	To be ordered in multiples of	Reference	To be ordered in multiples of	Reference
IP65 protection.	1	4825 0089	1	4825 0089
Integration kit for 144 x 96 mm cutout	1	4825 0088	1	4825 0088
Fuse holders to protect voltage inputs (type RM) 3 pole	4	5701 0018	4	5701 0018
Fuse holders to protect the auxiliary power supply (type RM) 1 pole + neutral	6	5701 0017	6	5701 0017
gG 10x38 0.5 A fuses	10	6012 0000	10	6012 0000
Range of current transformers	1	See "Current transformers" pages	1	See "Current transformers" pages
Ferrite for use with communication modules	1	4899 0011		4899 0011
PT100 temperature probe, M6 screw	1	4825 0208	1	4825 0208
PT100 temperature probe, M6 lug	1	4825 0209	1	4825 0209
Associated DIRIS software		See "Easy Config System" pages		
Automatic CT short-circuiting device		See "Current transformers" pages		

Expert Services

- Study, definition, advice, implementation, maintenance and training... Our experts "Expert Services" offer complete support for the success of your project.

