

REVISION 改 歴

LTR 記号	DESCRIPTION 内容	DATE 日付	APRO 承認
△	Changed Material (BSBM to STEEL) 材質変更 黄銅→鉄	06/08/21	M.K
△	Changed Width (11mm to 10mm) 寸法変更 11mm→10mm	06/08/21	M.K
△	Changed Pitch (1.0 to 0.75) ネジピッチ変更 P1.0→P0.75	06/08/21	M.K

回路図

CIRCUIT

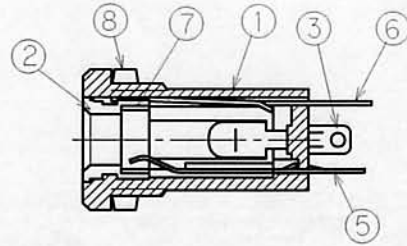
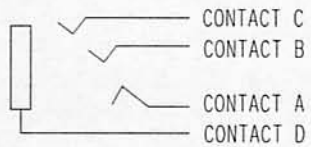

仕様  
SPECIFICATION

耐電圧 : AC500V 1分間  
 DIELECTRIC STRENGTH:500V AC FOR ONE MINUTE.  
 接触抵抗 : 50mΩ以下  
 CONTACT RESISTANCE:50mΩ MAX  
 絶縁抵抗 : DC100Vにて100MΩ以上  
 INSULATION RESISTANCE:100MΩ MIN.AT 500V DC.

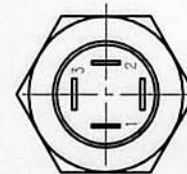
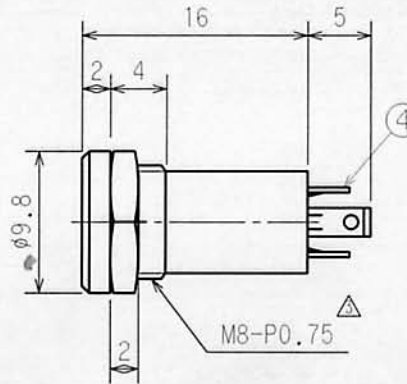
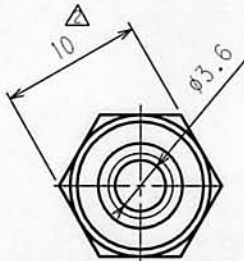

取付穴参考寸法

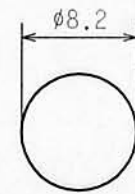

(板厚t=2.0MAX)

LET	PART NAME	MATERIAL	QTY	FINISH	NOTE	FINISH 処理	TOLERANCE	SCALE	DATE	DESIG	DRAW	INSPE	APRO
8	ナット HEX NUT	STEEL △	1	Ni									
7	絶縁チューブ INSULATION TUBE	PVC	1										
6	スリーブプラグ CONTACT D	BRASS t=0.3	1	Ni			±0.3	2/1	02/10/24	K.S	N.I		M.K
5	リングプラグ CONTACT C	FAB-EH t=0.25	1	Ni		MODEL				QTY	PART NAME	4-con. 3.5mm Panel Mtg.Jack	
4	リングラグ CONTACT B	FAB-EH t=0.25	1	Au		型式					品名	No.MJ-064H	
3	チップラグ CONTACT A	FAB-EH t=0.25	1	Ni		MATERIAL					DRAW.NO	MJ064H	
2	スリーブメタル SLEEVE	BRASS	1	Ni		材質					図番		
1	本体 HOUSING	PA	1			FINISH							
						処理						 MARUSHIN ELECTRIC MFG.CO.,LTD.	