









Ficha técnica

Rueda BH-PPI 2-2465

Codigo				Tipo cojinete Eje					
2-2465	100	80	22	—	70x55	54x38	6	132	90



Características

Fabricada con chapa de acero hasta 2 m/m de espesor.
Soporte con doble rodamiento a bolas.
Acabado cincado brillante.
Fabricadas según normas europeas EN 12528/12530.

Datos técnicos

Diámetro: 100 mm
Carga: 80 kg
Tipo de cojinete: Cojinete Liso
Ancho de Banda de rodadura: 22 mm
Medidas de placa superior: 70x55 mm
Distancia entre agujeros: 54x38 mm
Diámetro agujero sujeción platina: 6 mm
Altura total: 132 mm
Radio de giro: 90 mm

Archivos CAD

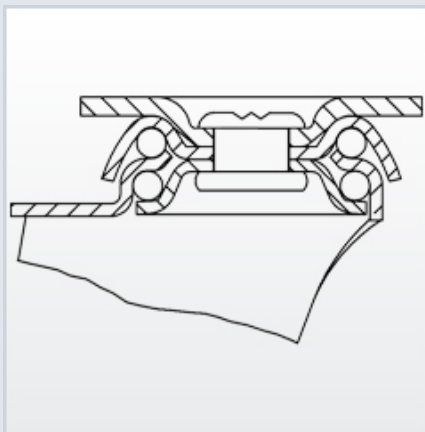

Rueda

PPI (Poliuretano)
Núcleo de poliamix y banda de poliuretano(95° shore A)
Rango de temperatura: -25° ÷ +80°

Productos relacionados

