

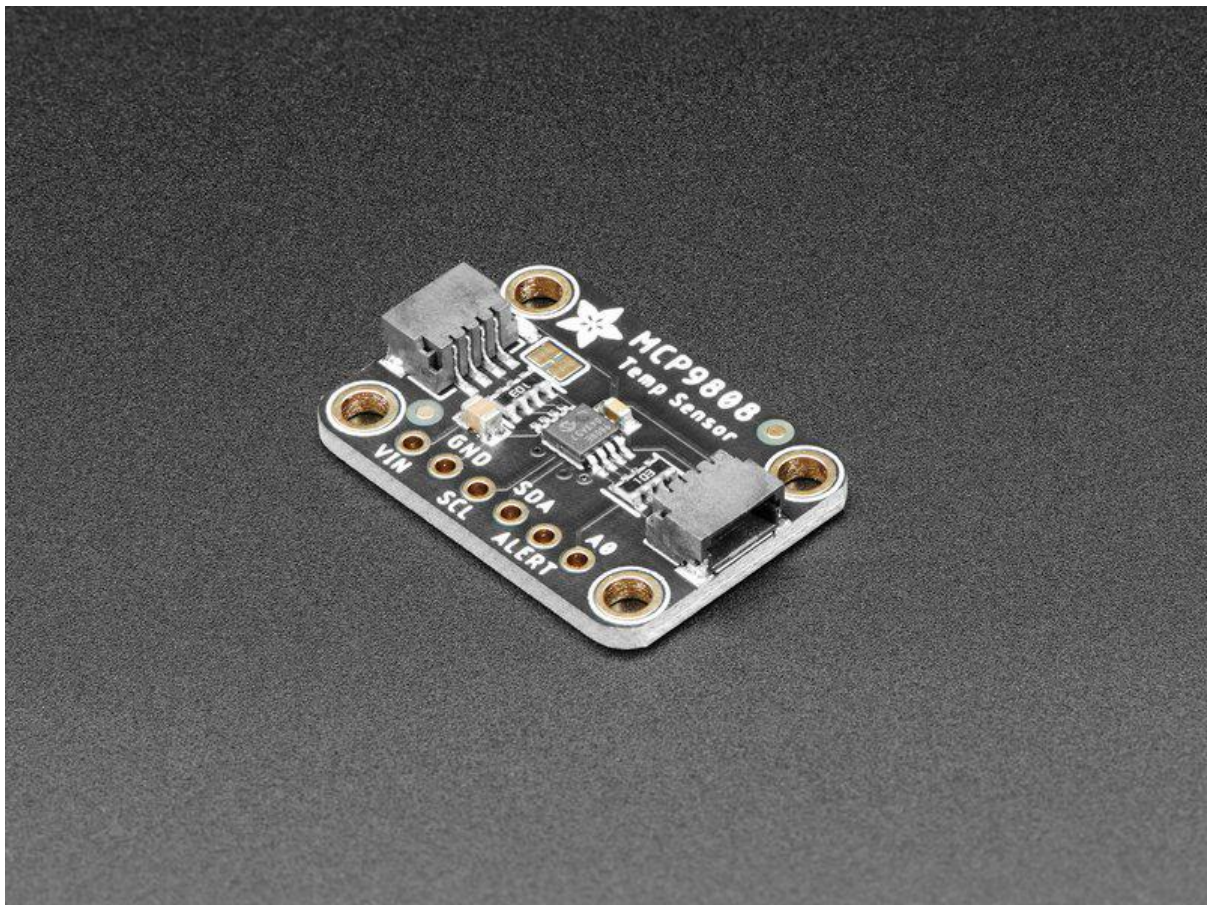

Adafruit MCP9808 Precision I2C Temperature Sensor Guide

Created by lady ada



<https://learn.adafruit.com/adafruit-mcp9808-precision-i2c-temperature-sensor-guide>

Last updated on 2022-07-20 03:14:26 PM EDT

Table of Contents

Overview	3
Pinouts	6
<ul style="list-style-type: none">• Power Pins• I2C Data Pins• Optional Pins	
Arduino Code	8
<ul style="list-style-type: none">• Prepare the header strip:• Add the breakout board:• And Solder!• Arduino Wiring• Download Adafruit_MCP9808• Load Demo	
Python & CircuitPython	14
<ul style="list-style-type: none">• CircuitPython Microcontroller Wiring• Python Computer Wiring• CircuitPython Installation of MCP9808 Library• Python Installation of MCP9808 Library• CircuitPython & Python Usage• Full Example Code	
Python Docs	19
WipperSnapper	19
<ul style="list-style-type: none">• What is WipperSnapper• Wiring• Usage	
Downloads	26
<ul style="list-style-type: none">• Datasheets & Files• Schematic and Fab Print for STEMMA QT Version• Schematic and Fab Print for Original Version	

Overview

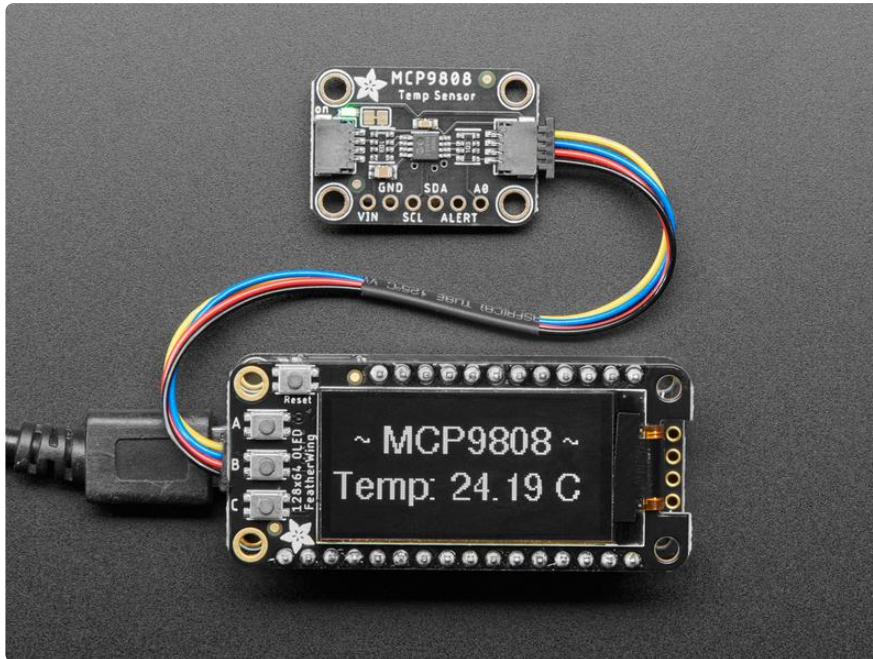

This I2C digital temperature sensor is one of the more accurate/precise we've ever seen, with a typical accuracy of $\pm 0.25^{\circ}\text{C}$ over the sensor's -40°C to $+125^{\circ}\text{C}$ range and precision of $+0.0625^{\circ}\text{C}$. They work great with any microcontroller using standard i2c. There are 3 address pins so you can connect up to 8 to a single I2C bus without address collisions. Best of all, a wide voltage range makes it usable with 2.7V to 5.5V logic!

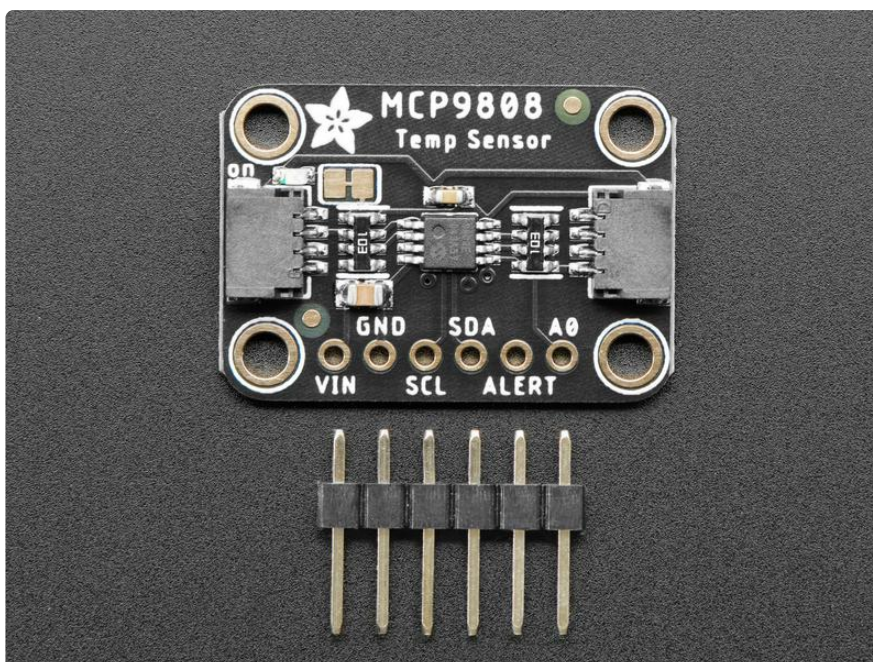

Unlike the DS18B20, this sensor does not come in through-hole package so we placed this small sensor on a breakout board PCB for easy use. The PCB includes

mounting holes, and pull down resistors for the 3 address pins. We even wrote a lovely little library for Arduino that will work with any Arduino compatible. You'll be up and running in 15 minutes or less.

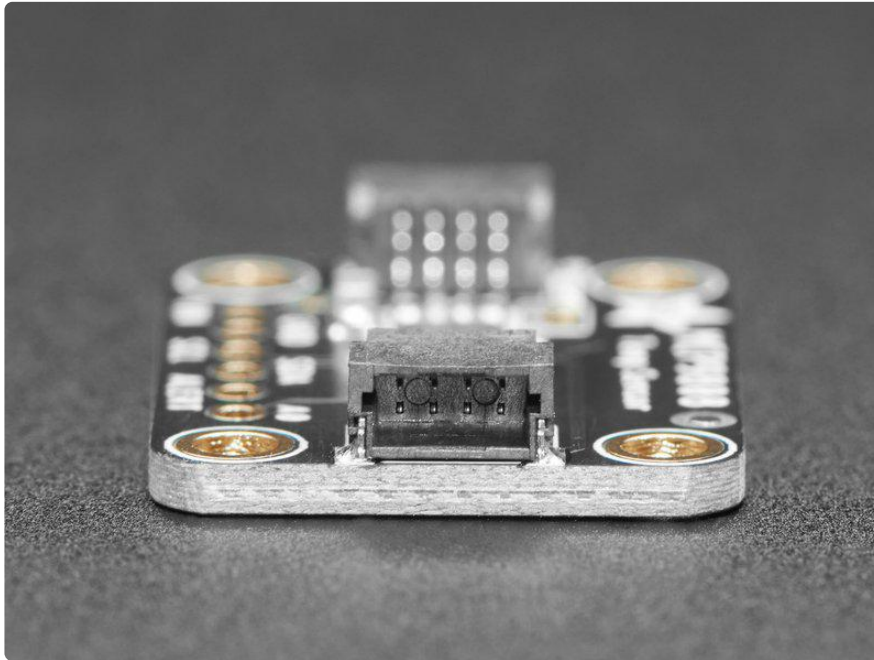

To get you going fast, we spun up a custom made PCB with the MCP9808 and some supporting circuitry such as pull-up resistors and capacitors, in the [STEMMA QT form factor \(https://adafru.it/LBQ\)](https://adafru.it/LBQ), making them easy to interface with. The [STEMMA QT connectors \(https://adafru.it/JqB\)](https://adafru.it/JqB) on either side are compatible with the [SparkFun Qwiic \(https://adafru.it/Fpw\)](https://adafru.it/Fpw) I2C connectors. This allows you to make solderless connections between your development board and the MCP9808 or to chain them with a wide range of other sensors and accessories using a [compatible cable \(https://adafru.it/JnB\)](https://adafru.it/JnB). [QT Cable is not included, but we have a variety in the shop \(https://adafru.it/JnB\)](https://adafru.it/JnB).

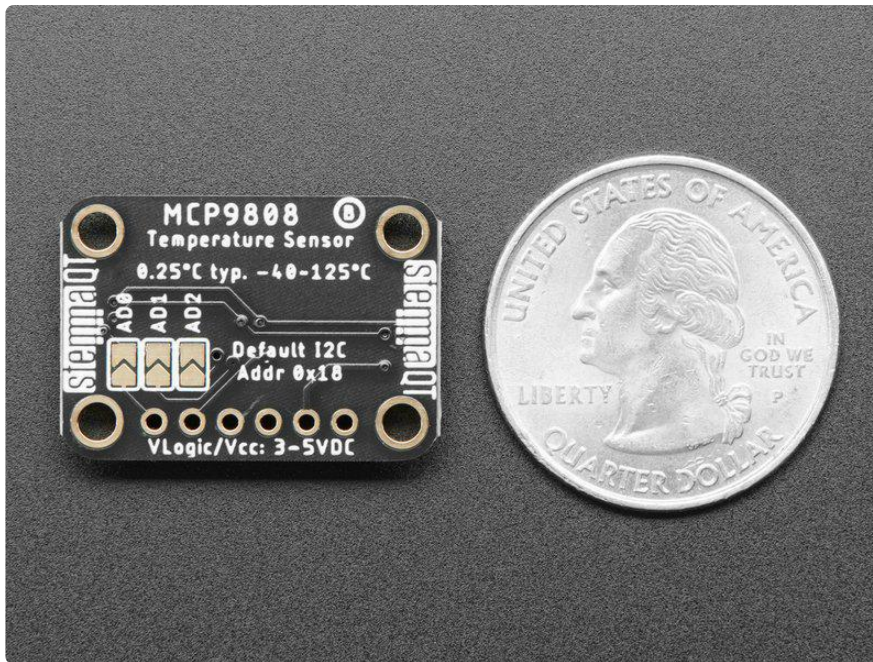

- Simple I2C control
- Up to 8 on a single I2C bus with adjustable address pins
- 0.25°C typical precision over -40°C to 125°C range (0.5°C guaranteed max from -20°C to 100°C)
- 0.0625°C resolution
- 2.7V to 5.5V power and logic voltage range
- Operating Current: 200 μ A (typical)

There are two versions of this board - the STEMMA QT version shown above, and the original header-only version shown below. Code works the same on both!

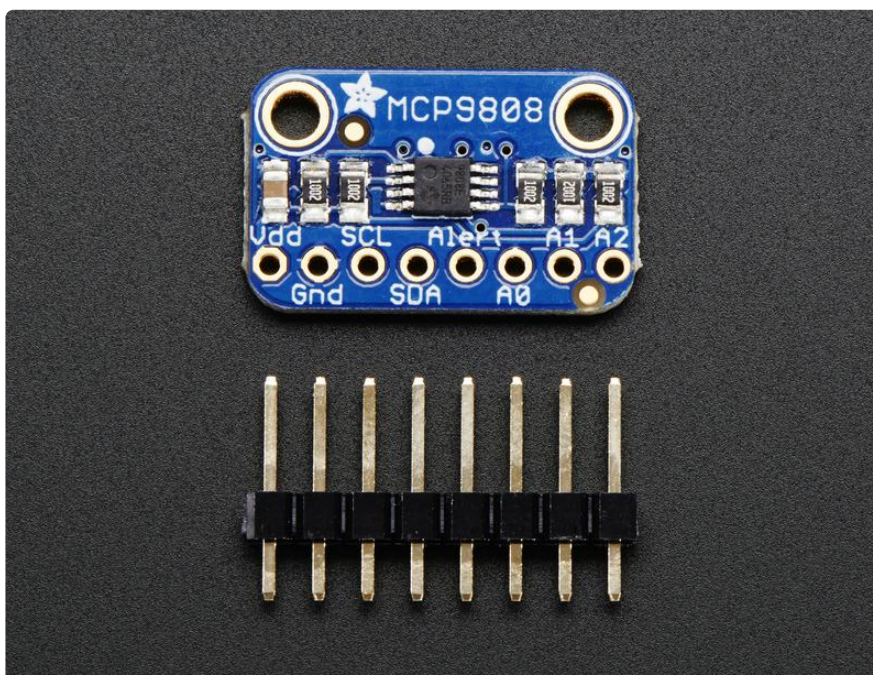

Pinouts

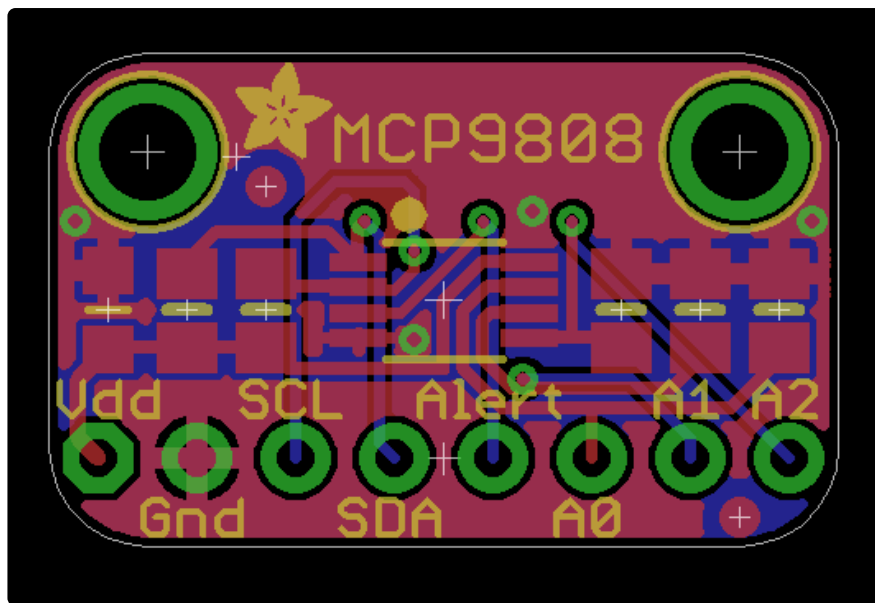
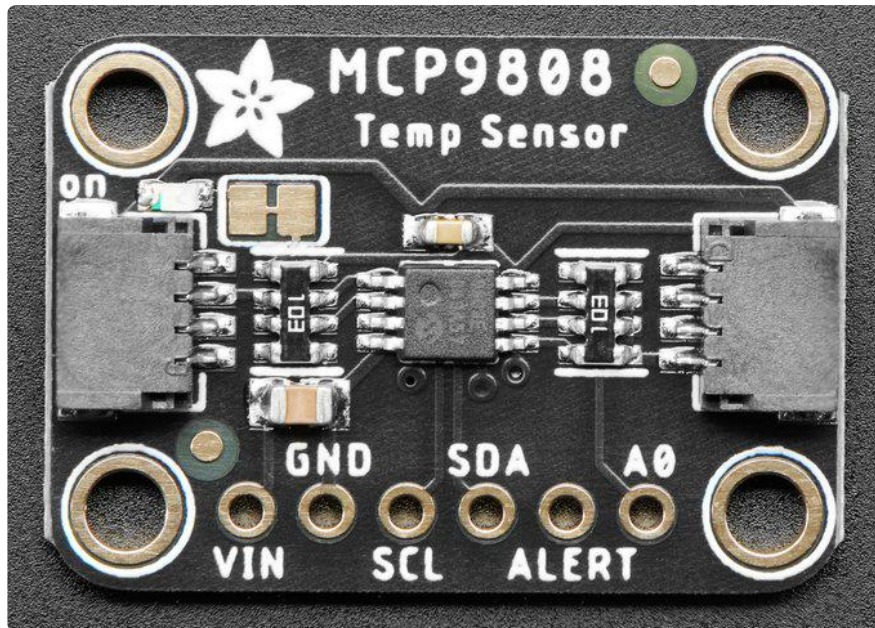

The MCP9808 is a very straight-forward sensor, lets go thru all the pins so you can understand what you need to connect to get started

Power Pins

- VIN (VDD on header-only version) - This is the positive power and logic level pin. It can be 2.7-5.5VDC, so fine for use with 3 or 5V logic. Power VIN (VDD) with whatever logic level you plan to use on the i2c lines.

- GND - this is the ground power and logic reference pin.

I2C Data Pins

- SCL - this is the I2C clock pin. There's a 10K pull-up already on the board, so connect this directly to the i2c master clock pin on your microcontroller
- SDA - this is the I2C data pin. There's a 10K pull-up already on the board, so connect this directly to the i2c master data pin on your microcontroller
- [STEMMA QT \(https://adafru.it/Ft4\)](https://adafru.it/Ft4) - These connectors allow you to connect to development boards with STEMMA QT connectors, or to other things, with [various associated accessories \(https://adafru.it/Ft6\)](https://adafru.it/Ft6).

Optional Pins

These are pins you don't need to connect to unless you want to!

- Alert - This is the interrupt/alert pin from the MCP9808. The chip has some capability to 'alert' you if the chip temperature goes above or below a set amount. This output can trigger to let you know. It is open collector so you need to use a pull-up resistor if you want to read signal from this pin.
- A0 (as well as A1 and A2 on the original version) - These are the address select pins. Since you can only have one device with a given address on an i2c bus, there must be a way to adjust the address if you want to put more than one MCP9808 on a shared i2c bus. The A0/A1/A2 pins set the bottom three bits of the i2c address. There are pull-down resistors on the board so connect them to VDD to set the bits to '1'. They are read on power up, so de-power and re-power to reset the address

The default address is 0x18 and the address can be calculated by 'adding' the A0/A1/A2 to the base of 0x18

A0 sets the lowest bit with a value of 1, A1 sets the middle bit with a value of 2 and A2 sets the high bit with a value of 4. The final address is $0x18 + A2 + A1 + A0$.

So for example if A2 is tied to VDD and A0 is tied to VDD, the address is $0x18 + 4 + 1 = 0x1D$.

If only A0 is tied to VDD, the address is $0x18 + 1 = 0x19$

If only A1 is tied to VDD, the address is $0x18 + 2 = 0x1A$

If only A2 is tied to VDD, the address is $0x18 + 4 = 0x1C$

This address information applies to both versions of the MCP9808 breakout. The STEMMA QT version has jumpers on the back that you can use to tie the address pins to VDD.

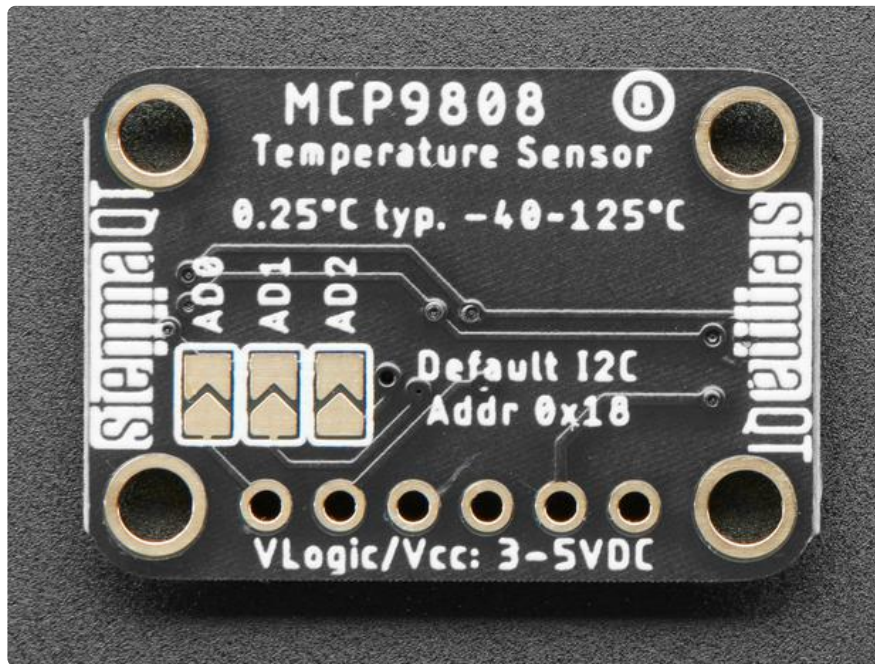

Arduino Code

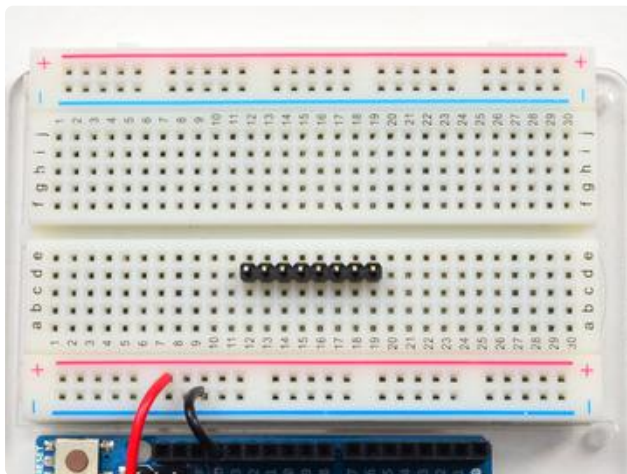

Prepare the header strip:
Cut the strip to length if necessary. It will be easier to solder if you insert it into a breadboard - long pins down

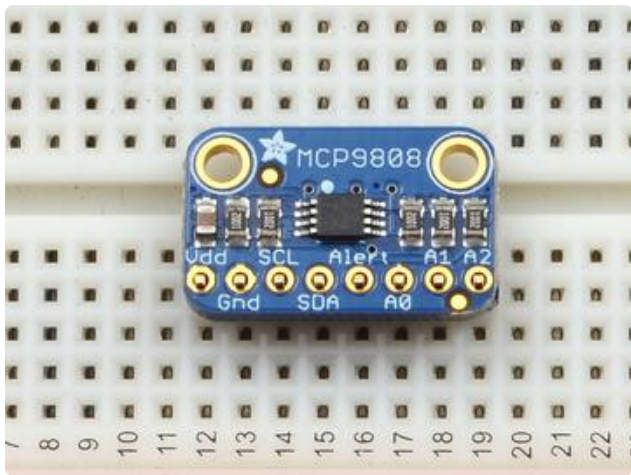

Add the breakout board:

Place the breakout board over the pins so that the short pins poke through the breakout pads

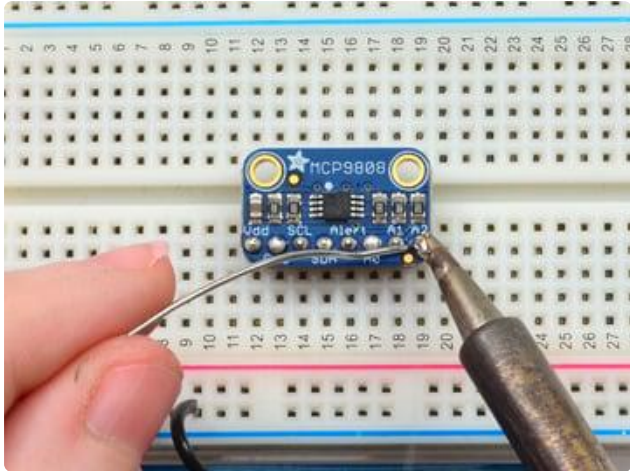
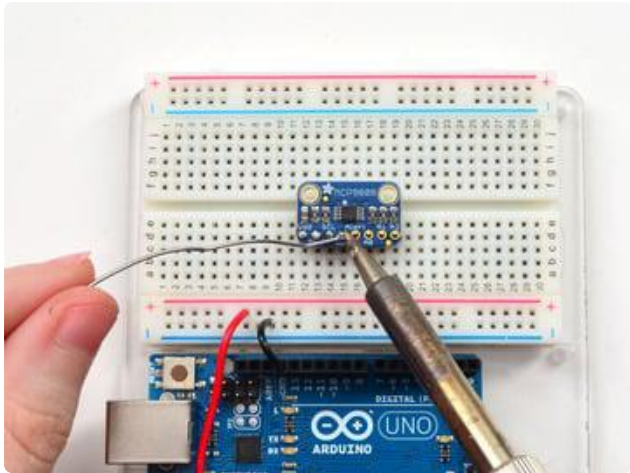
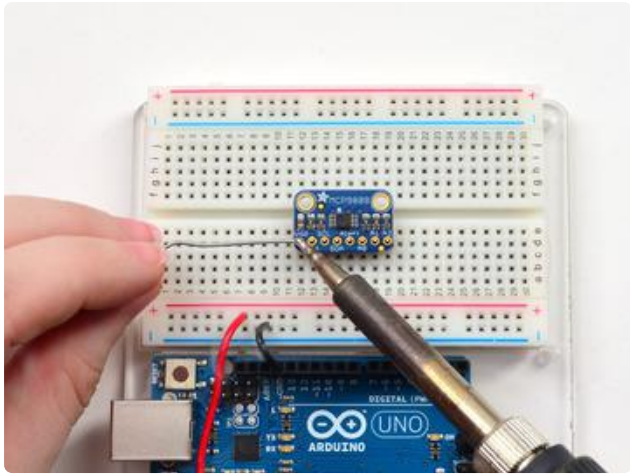

And Solder!

Be sure to solder all pins for reliable electrical contact.

(For tips on soldering, be sure to check out our [Guide to Excellent Soldering \(https://adafruit.it/aTk\)](https://adafruit.it/aTk)).

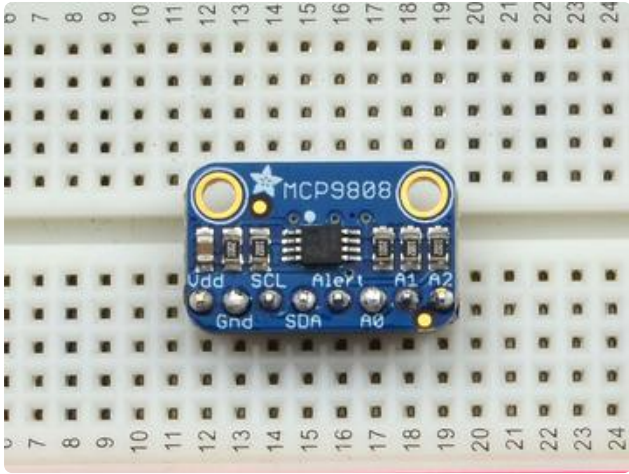

You're done! Check your solder joints visually and continue onto the next steps

Arduino Wiring

You can easily wire this sensor to any microcontroller, we'll be using an Arduino

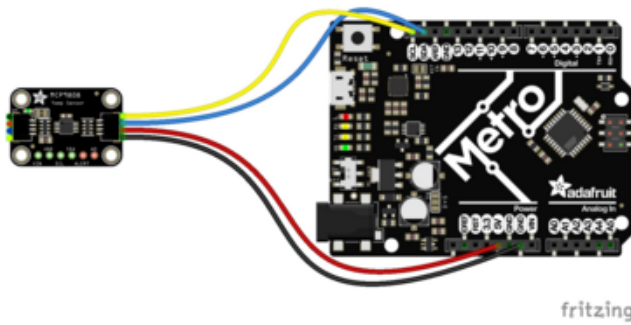

fritzing

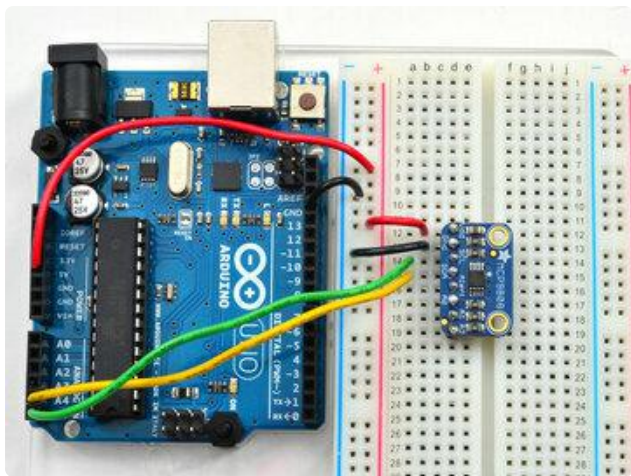
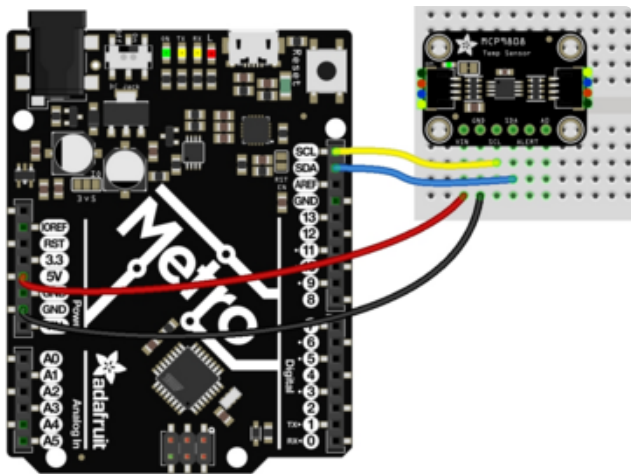

Connect VIN (Vdd) (red wire on the STEMMA QT version) to the power supply, 3V or 5V is fine. Use the same voltage that the microcontroller logic is based off of. For most Arduinos, that is 5V

Connect GND (black wire on the STEMMA QT version) to common power/data ground

Connect the SCL pin to the I2C clock SCL pin on your Arduino (yellow wire on STEMMA QT version). On an UNO & '328 based Arduino, this is also known as A5, on a Mega it is also known as digital 21 and on a Leonardo/Micro, digital 3

Connect the SDA pin to the I2C data SDA pin on your Arduino (blue wire on STEMMA QT version). On an UNO & '328 based Arduino, this is also known as A4, on a Mega it is also known as digital 20 and on a Leonardo/Micro, digital 2

The MCP9808 has a default I2C address of 0x18 but you can set the address to any of 8 values between 0x18 and 0x1F so you can have up to 8 of these sensors all sharing the same SCL/SDA pins.

Download Adafruit_MCP9808

To begin reading sensor data, you will need to download the Adafruit MCP9808 library from the Arduino library manager.

Open up the Arduino library manager:

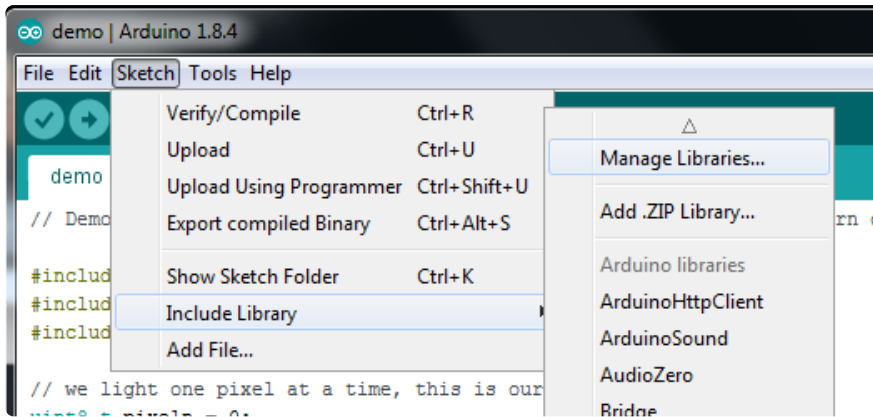

Search for the Adafruit MCP9808 library and install it

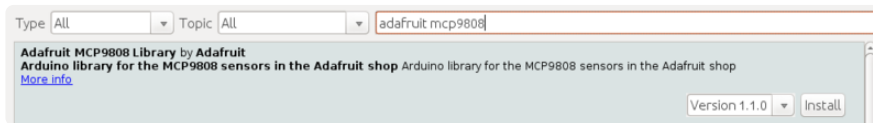

We also have a great tutorial on Arduino library installation at: <http://learn.adafruit.com/adafruit-all-about-arduino-libraries-install-use> (<https://adafru.it/aYM>)

Load Demo

Open up File->Examples->Adafruit_MCP9808->mcp9808test and upload to your Arduino wired up to the sensor

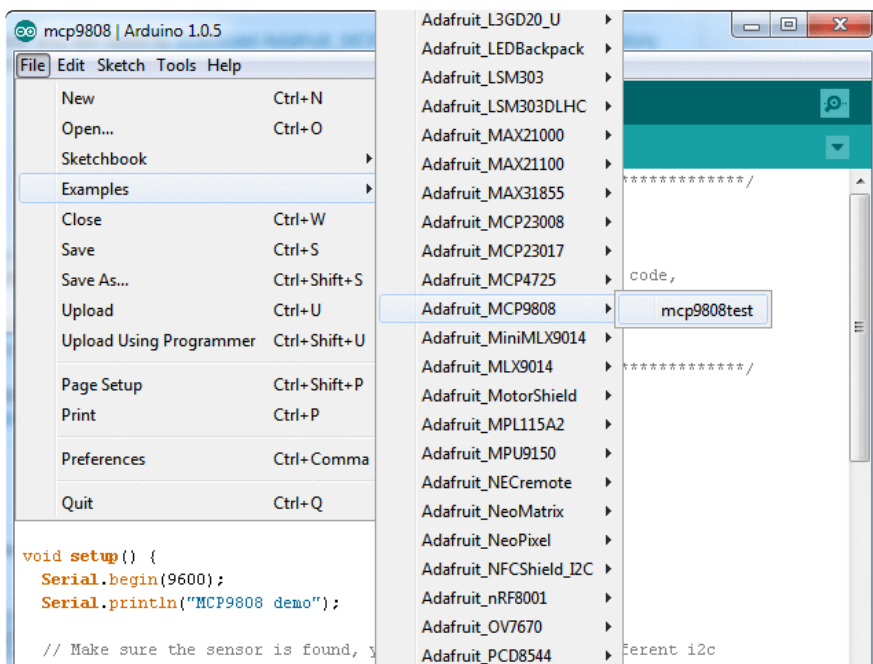

Thats it! Now open up the serial terminal window at 9600 speed to see the temperature in real time. You can try touching your finger to the sensor to see the

temperature rise.

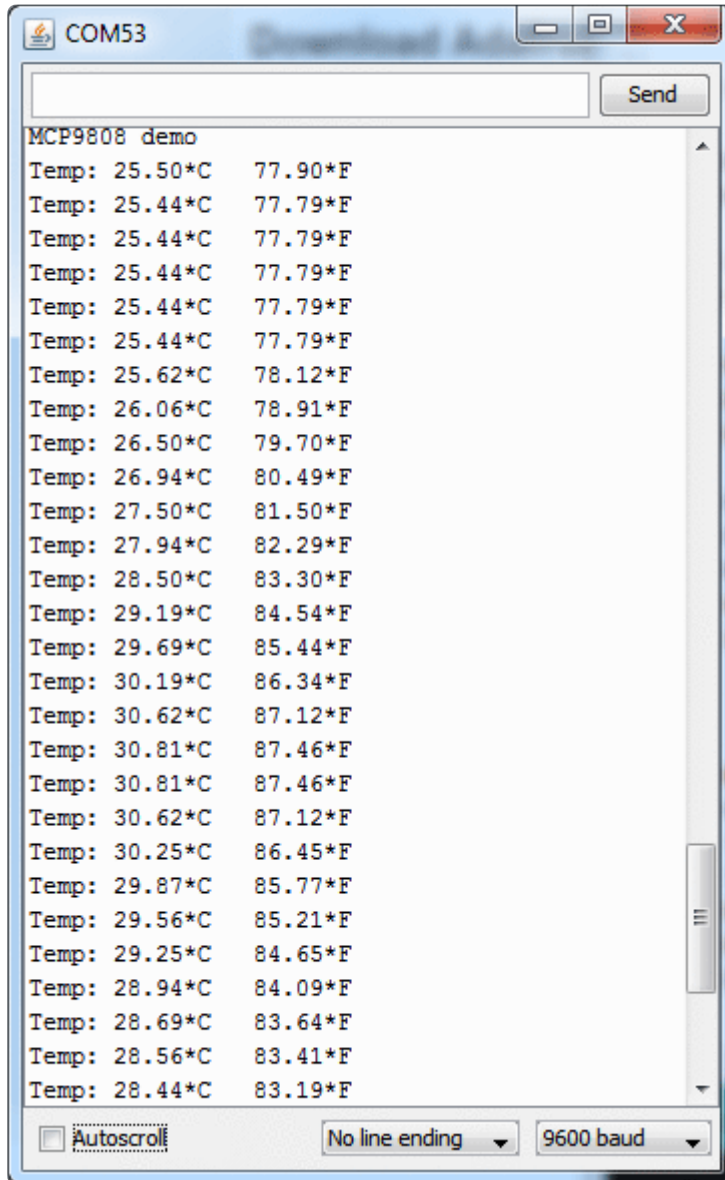

Python & CircuitPython

It's easy to use the MCP9808 sensor with Python or CircuitPython and the [Adafruit CircuitPython MCP9808 \(https://adafru.it/zcr\)](https://adafru.it/zcr) module. This module allows you to easily write Python code that reads the temperature from the sensor.

You can use this sensor with any CircuitPython microcontroller board or with a computer that has GPIO and Python [thanks to Adafruit_Blinka, our CircuitPython-for-Python compatibility library \(https://adafru.it/BSN\)](https://adafru.it/BSN).

CircuitPython Microcontroller Wiring

First wire up a MCP9808 to your board exactly as shown on the previous pages for Arduino. Here's an example of wiring a Feather M0 to the sensor:

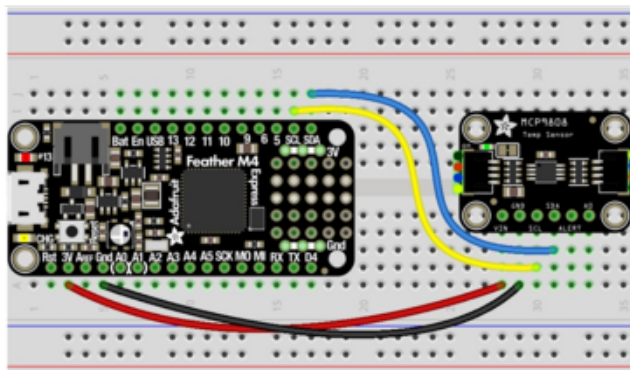
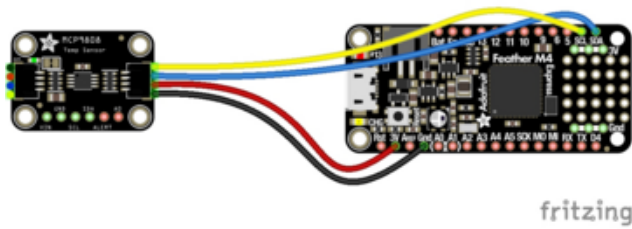

Board 3V to sensor VIN (Vdd) (red wire on STEMMA QT version)

Board GND to sensor GND (black wire on STEMMA QT version)

Board SCL to sensor SCL (yellow wire on STEMMA QT version)

Board SDA to sensor SDA (blue wire on STEMMA QT version)

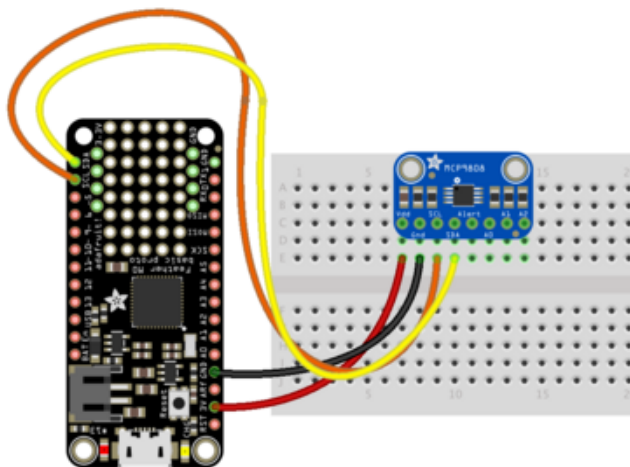

Python Computer Wiring

Since there's dozens of Linux computers/boards you can use we will show wiring for Raspberry Pi. For other platforms, [please visit the guide for CircuitPython on Linux to see whether your platform is supported](https://adafru.it/BSN) (<https://adafru.it/BSN>).

Here's the Raspberry Pi wired with I2C:

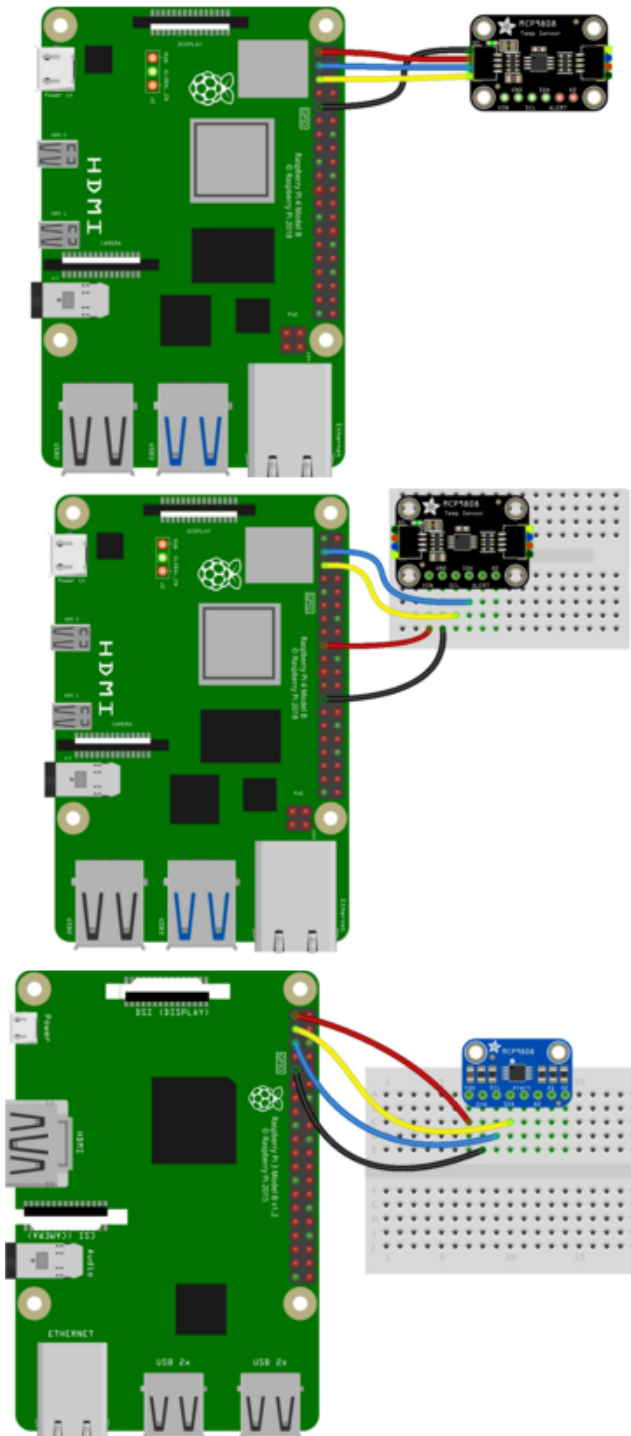

Pi 3V3 to sensor VIN (red wire on STEMMA QT version)

Pi GND to sensor GND (black wire on STEMMA QT version)

Pi SCL to sensor SCK (yellow wire on STEMMA QT version)

Pi SDA to sensor SDA (blue wire on STEMMA QT version)

CircuitPython Installation of MCP9808 Library

Next you'll need to install the [Adafruit CircuitPython MCP9808 \(https://adafru.it/zcr\)](https://adafru.it/zcr) library on your CircuitPython board.

First make sure you are running the [latest version of Adafruit CircuitPython \(https://adafru.it/tBa\)](https://adafru.it/tBa) for your board.

Next you'll need to install the necessary libraries to use the hardware--carefully follow the steps to find and install these libraries from [Adafruit's CircuitPython library bundle \(https://adafru.it/zdx\)](https://adafru.it/zdx). For example the Circuit Playground Express guide has [a great page on how to install the library bundle \(https://adafru.it/Bf2\)](https://adafru.it/Bf2) for both express and non-express boards.

Remember for non-express boards like the Trinket M0, Gemma M0, and Feather/Metro M0 basic you'll need to manually install the necessary libraries from the bundle:

- `adafruit_mcp9808.mpy`
- `adafruit_bus_device`

Before continuing make sure your board's lib folder or root filesystem has the `adafruit_mcp9808.mpy`, and `adafruit_bus_device` files and folders copied over.

Next [connect to the board's serial REPL \(https://adafru.it/pMf\)](https://adafru.it/pMf) so you are at the CircuitPython `>>>` prompt.

Python Installation of MCP9808 Library

You'll need to install the `Adafruit_Blinka` library that provides the CircuitPython support in Python. This may also require enabling I2C on your platform and verifying you are running Python 3. [Since each platform is a little different, and Linux changes often, please visit the CircuitPython on Linux guide to get your computer ready \(https://adafru.it/BSN\)](https://adafru.it/BSN)!

Once that's done, from your command line run the following command:

- `sudo pip3 install adafruit-circuitpython-mcp9808`

If your default Python is version 3 you may need to run 'pip' instead. Just make sure you aren't trying to use CircuitPython on Python 2.x, it isn't supported!

CircuitPython & Python Usage

To demonstrate the usage of the sensor we'll initialize it and read the temperature. First initialize the I2C connection and library by running:

```
import board
import busio
import adafruit_mcp9808
i2c = busio.I2C(board.SCL, board.SDA)
mcp = adafruit_mcp9808.MCP9808(i2c)
```

Now you can read the temperature property to retrieve the temperature from the sensor in degrees Celsius:

```
print('Temperature: {} degrees C'.format(mcp.temperature))
```

```
>>> print('Temperature: {} degrees C'.format(mcp.temperature))
Temperature: 21.25 degrees C
>>> █
```

That's all there is to reading temperature with the MCP9808 and CircuitPython code!

Full Example Code

```
# SPDX-FileCopyrightText: 2021 ladyada for Adafruit Industries
# SPDX-License-Identifier: MIT

import time
import board
import adafruit_mcp9808

i2c = board.I2C() # uses board.SCL and board.SDA

# To initialise using the default address:
mcp = adafruit_mcp9808.MCP9808(i2c)

# To initialise using a specified address:
# Necessary when, for example, connecting A0 to VDD to make address=0x19
# mcp = adafruit_mcp9808.MCP9808(i2c_bus, address=0x19)

while True:
    tempC = mcp.temperature
    tempF = tempC * 9 / 5 + 32
    print("Temperature: {} C {} F ".format(tempC, tempF))
    time.sleep(2)
```

Python Docs

[Python Docs \(https://adafru.it/C3s\)](https://adafru.it/C3s)

WipperSnapper

What is WipperSnapper

WipperSnapper is a firmware designed to turn any WiFi-capable board into an Internet-of-Things device without programming a single line of code. WipperSnapper connects to [Adafruit IO \(https://adafru.it/fsU\)](https://adafru.it/fsU), a web platform designed ([by Adafruit! \(https://adafru.it/Bo5\)](https://adafru.it/Bo5)) to display, respond, and interact with your project's data.

Simply load the WipperSnapper firmware onto your board, add credentials, and plug it into power. Your board will automatically register itself with your Adafruit IO account.

From there, you can add components to your board such as buttons, switches, potentiometers, sensors, and more! Components are dynamically added to hardware, so you can immediately start interacting, logging, and streaming the data your projects produce without writing code.

If you've never used WipperSnapper, click below to read through the quick start guide before continuing.

Quickstart: Adafruit IO
WipperSnapper

<https://adafru.it/Vfd>

Wiring

First, wire up an MCP9808 to your board exactly as follows. Here is an example of the MCP9808 wired to an [Adafruit ESP32 Feather V2 \(https://adafru.it/ZbS\)](https://adafru.it/ZbS) using I2C [with a STEMMA QT cable \(no soldering required\) \(https://adafru.it/FNS\)](https://adafru.it/FNS)

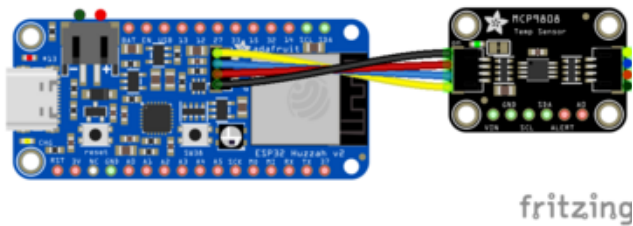

- Board 3V to sensor VIN (red wire on STEMMA QT)
- Board GND to sensor GND (black wire on STEMMA QT)
- Board SCL to sensor SCL (yellow wire on STEMMA QT)
- Board SDA to sensor SDA (blue wire on STEMMA QT)

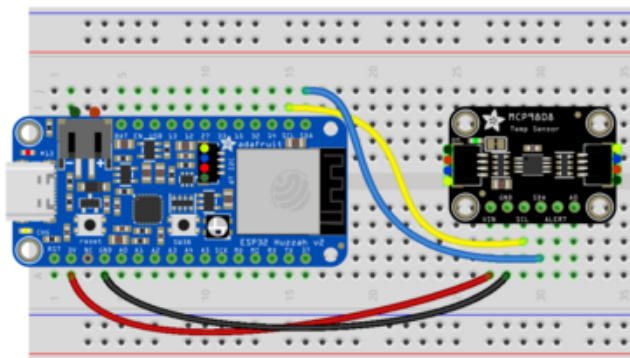

Usage

Connect your board to Adafruit IO Wippersnapper and [navigate to the WipperSnapper board list \(https://adafru.it/TAu\)](https://adafru.it/TAu).

On this page, select the WipperSnapper board you're using to be brought to the board's interface page.

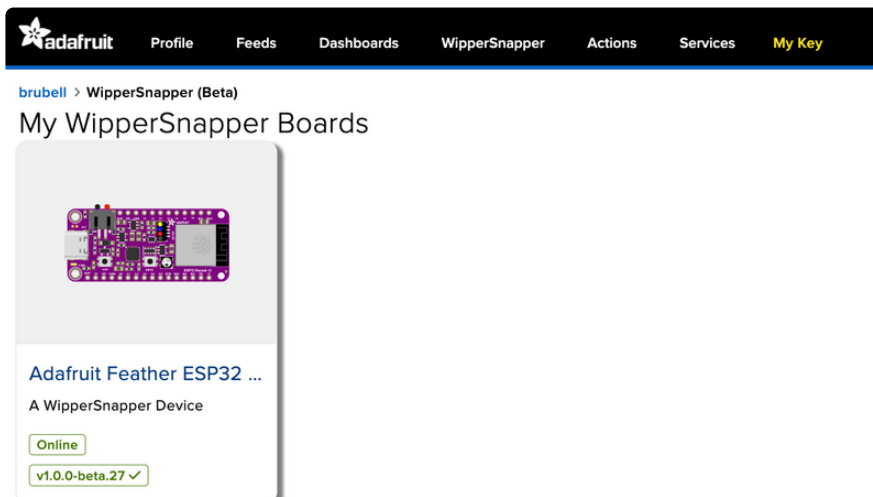

If you do not see your board listed here - you need [to connect your board to Adafruit IO](https://adafru.it/Vfd) (<https://adafru.it/Vfd>) first.

Adafruit Feather ESP32...

Adafruit Feather ESP32 V2 by Adafruit



On the device page, quickly check that you're running the latest version of the WipperSnapper firmware.

The device tile on the left indicates the version number of the firmware running on the connected board.

If the firmware version is green with a checkmark - continue with this guide. If the firmware version is red with an "X" - [update to the latest WipperSnapper firmware](https://adafru.it/Vfd) (<https://adafru.it/Vfd>) on your board before continuing.

Next, make sure the sensor is plugged into your board and click the Start I2C Scan button.

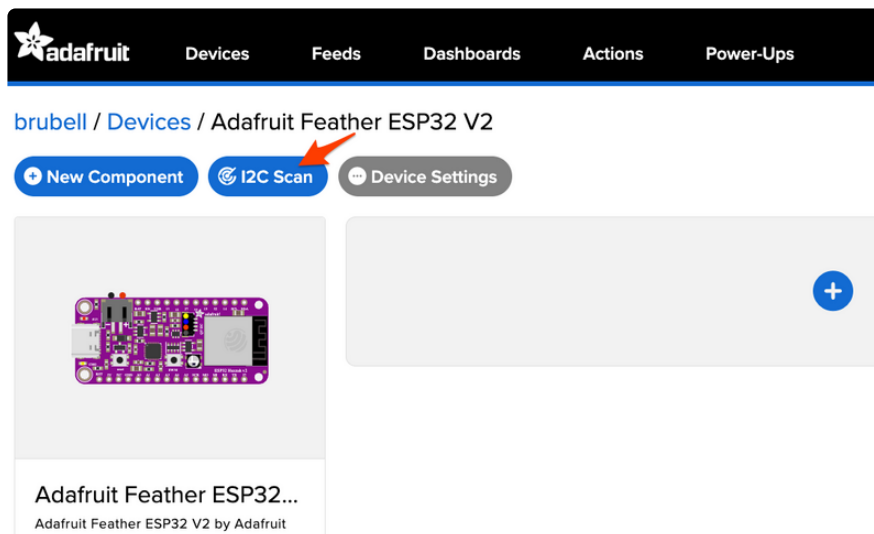

You should see the MCP9808's default I2C address of `0x18` pop-up in the I2C scan list.

I2C Scan Complete



	0	1	2	3	4	5	6	7	8	9	a	b	c	d	e	f
00								--	--	--	--	--	--	--	--	--
10	--	--	--	--	--	--	--	--	18	--	--	--	--	--	--	--
20	--	--	--	--	--	--	--	--	--	--	--	--	--	--	--	--
30	--	--	--	--	--	--	--	--	--	--	--	--	--	--	--	--
40	--	--	--	--	--	--	--	--	--	--	--	--	--	--	--	--
50	--	--	--	--	--	--	--	--	--	--	--	--	--	--	--	--
60	--	--	--	--	--	--	--	--	--	--	--	--	--	--	--	--
70	--	--	--	--	--	--	--	--	--	--	--	--	--	--	--	--

Close

Scan Again

I don't see the sensor's I2C address listed!

First, double-check the connection and/or wiring between the sensor and the board.

Then, reset the board and let it re-connect to Adafruit IO WipperSnapper.

With the sensor detected in an I2C scan, we're ready to add the sensor to your board.

Click the New Component button or the + button to bring up the component picker.

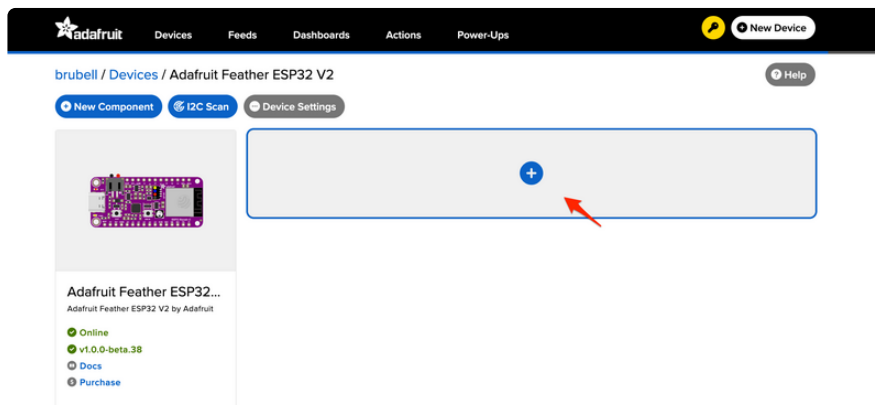

Select the MCP9808 from the component picker.

I2C Components

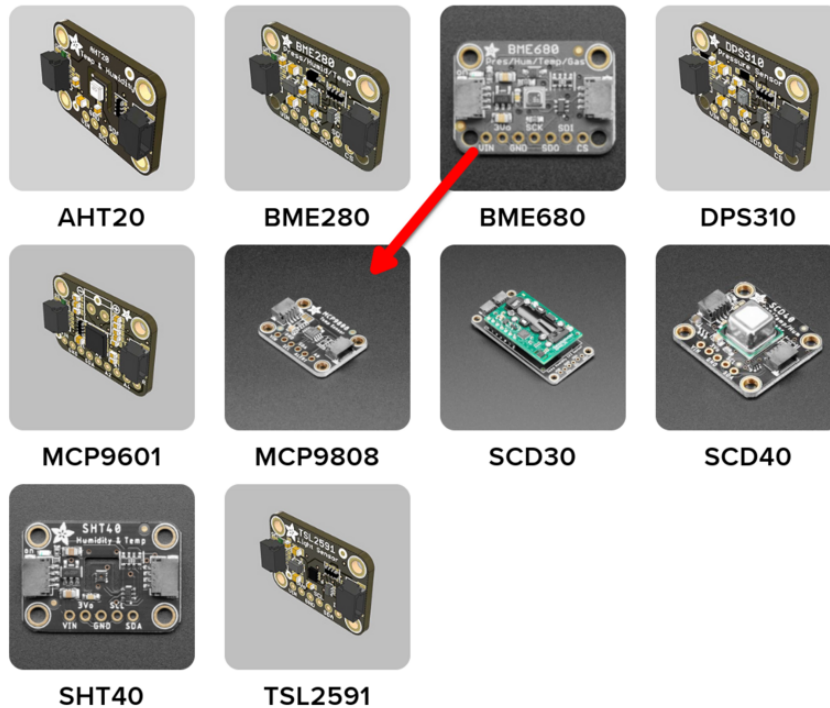

On the component configuration page, the MCP9808's sensor address should be listed along with the sensor's settings.

The Send Every option is specific to each sensor's measurements. This option will tell the Feather how often it should read from the MCP9808 sensor and send the data to Adafruit IO. Measurements can range from every 30 seconds to every 24 hours.

For this example, set the Send Every interval to every 30 seconds.

Create MCP9808 Component



Select I2C Address:

0x18

Enable MCP9808:
Temperature Sensor?

Name:

MCP9808: Temperature Sensor

Send Every:

Every 30 seconds

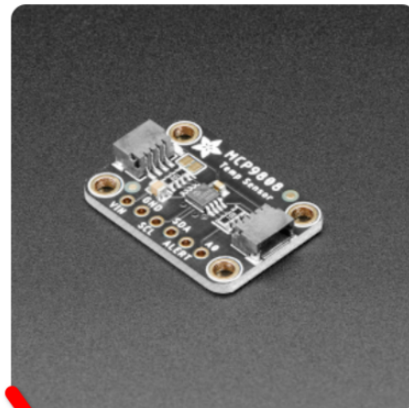

< Previous Step

Create Component

Your device interface should now show the sensor components you created. After the interval you configured elapses, WipperSnapper will automatically read values from the sensor and send them to Adafruit IO.

eherrada / Devices / Adafruit Feather ESP32 V2 Help

New Component I2C Scan Device Settings

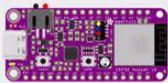

Adafruit Feather
ESP32 V2
by Adafruit

- Online
- v1.0.0-beta.40
- Docs
- Purchase

MCP9808: Temperature Sensor mcp9808:ambient-temp Settings

Create Action | Add to Dashboard

Raw Value: 23.56

+

To view the data that has been logged from the sensor, click on the graph next to the sensor name.

eherrada / Devices / Adafruit Feather ESP32 V2

[New Component](#)
[I2C Scan](#)
[Device Settings](#)

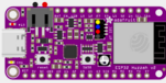

Adafruit Feather ESP32 V2
 by Adafruit

- Online
- v1.0.0-beta.40
- Docs
- Purchase

MCP9808: Temperature Sensor `mcp9808.ambient-temp`

[Create Action](#) | [Add to Dashboard](#)

Raw Value: 24.50

+

Here you can see the feed history and edit things about the feed such as the name, privacy, webhooks associated with the feed and more. If you want to learn more about how feeds work, [check out this page \(https://adafru.it/10aZ\)](https://adafru.it/10aZ).

For IO Free accounts, feed data is stored for a maximum of 30 days. If you'd like to store data for more than 30 days or increase your data rate to send more sensor measurements to Adafruit IO [upgrade your account to Adafruit IO Plus \(https://adafru.it/Eg3\)](https://adafru.it/Eg3).

eherrada / Feeds / MCP9808: Temperature Sensor

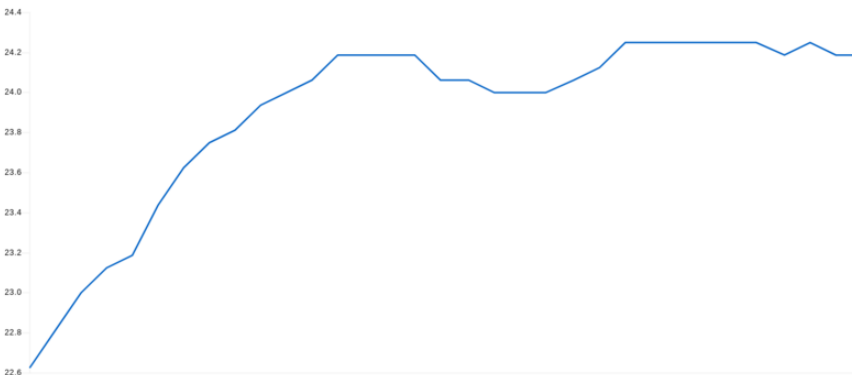

[+ Add Data](#)
[Download All Data](#)
[Filter](#)

< Prev First page 1 of 1 Next >

Created at	Value	Location
2022/07/13 3:31:11PM	24.1875	×
2022/07/13 3:30:41PM	24.1875	×
2022/07/13 3:30:11PM	24.25	×
2022/07/13 3:29:41PM	24.1875	✓

Downloads

Datasheets & Files

- [MCP9808 datasheet \(https://adafru.it/dfL\)](https://adafru.it/dfL)
- [EagleCAD PCB files on GitHub \(https://adafru.it/qib\)](https://adafru.it/qib)
- [Fritzing object in Adafruit Fritzing library \(https://adafru.it/c7M\)](https://adafru.it/c7M)

Schematic and Fab Print for STEMMMA QT Version

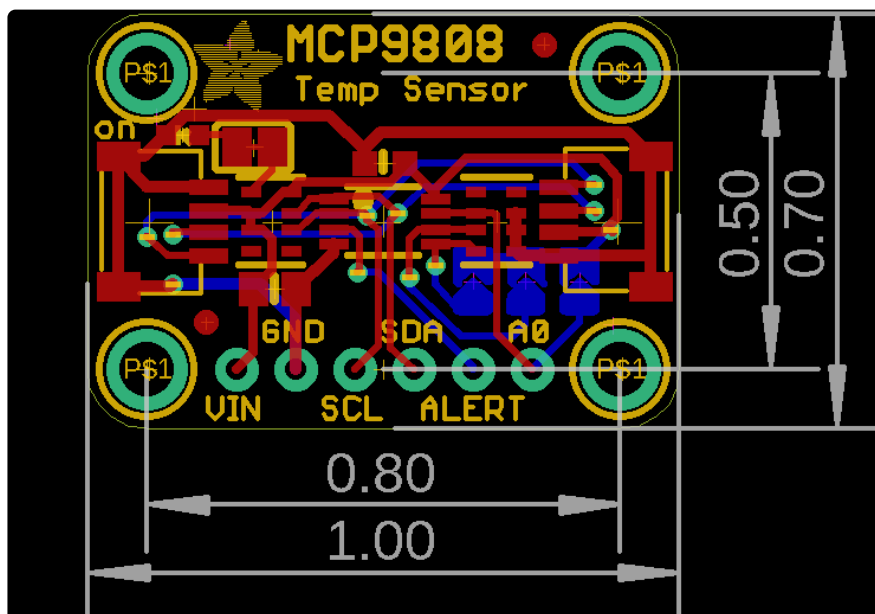
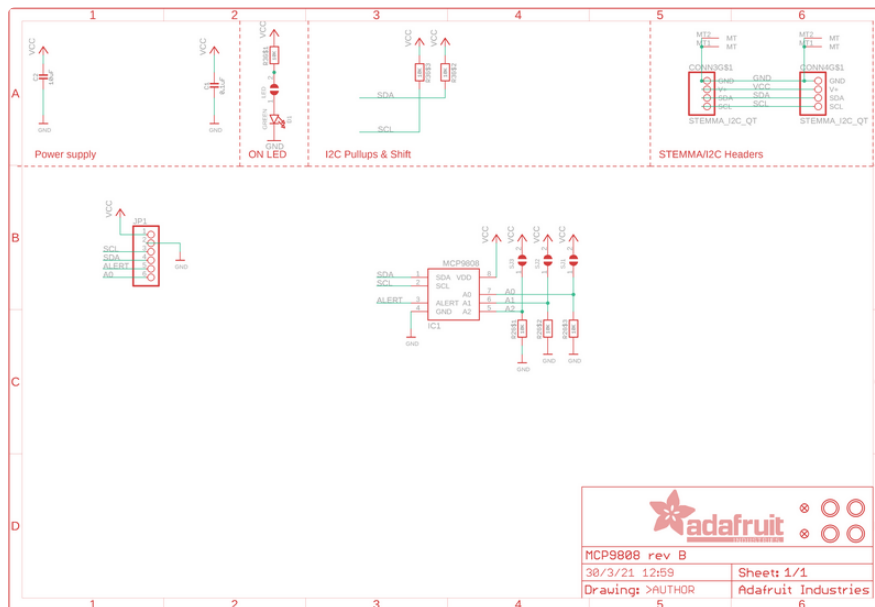

Schematic and Fab Print for Original Version

