

DATA SHEET

METAL GLAZED FILM RESISTORS

High Voltage, High Ohmic
HHV Series

±1%, ±5%

1/4W to 3W

RoHS compliant & Halogen Free



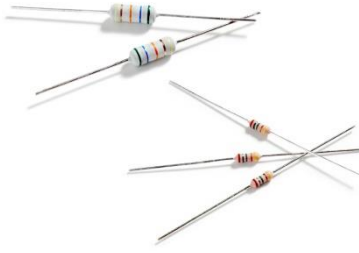

APPLICATIONS

- Power applications
- Home appliance
- Industry

FEATURES

- Metal glazed thick film
- Max. resistance up to 68Mohm
- Max. working voltage: 7KV
- Max. overload capability: 14KV
- Resistance to high temperature/humidity
- UL1676, VDE certified
- PPAP ready (HHV1WS)
- Flameproof coating equivalent to UL-94V-0
- RoHS compliant & halogen-free

ORDERING INFORMATION

Part number of the high voltage, high ohmic metal glaze film resistor are identified by the series, power rating, tolerance, packing, temperature coefficient, forming and resistance value and suffix.

PART NUMBER

HHV **2WS** **J** **T** **-** **73-** **100K** **Y**
 (1) (2) (3) (4) (5) (6) (7) (8)

(1) SERIES NAME

HHV Series

(2) POWER RATING

-25 = 1/4W	1WS = 1W
50S = 1/2W	2SS = 2W
-50 = 1/2W	2WS = 2W
1SS = 1W	3SS = 3W

(3) TOLERANCE

F = ±1% J = ±5%

(4) PACKAGING TYPE

R = Reel Pack B = Bulk
 T = Box Pack

(5) TEMPERATURE COEFFICIENT OF RESISTANCE

- = Based on spec.

(6) FORMING

26- = 26mm	FK = FK Type
52- = 52.4mm	FFK = F-form Kink
73- = 73mm	FKK = FKK Type
M = M-Type Forming	PN = PANAsert
MB = M-form W/flat	AV = AVIsert
F = F Type	
FB- = FB- Type (for -25&50S)	

(7) RESISTANCE VALUE

E24 & E96 Series
 Example:
 100K = 100,000Ω, 1M = 1,000,000Ω, 10M = 10,000,000Ω

(8) Suffix

Y = Epoxy coating
 Null = Silicone coating

DIMENSIONS

Unit: mm



	Normal	Miniature	L	ψD	H	ϕd
HHV-25	HHV50S	6.3 ± 0.5	2.4 ± 0.2	28 ± 2.0	0.55 ± 0.05	
HHV-50	HHV1SS	9.0 ± 0.5	3.3 ± 0.3	26 ± 2.0	0.55 ± 0.05	
HHV1WS	HHV2SS	11.5 ± 1.0	4.5 ± 0.5	35 ± 2.0	0.8 ± 0.05	
HHV2WS	HHV3SS	15.5 ± 1.0	5.0 ± 0.5	33 ± 2.0	0.8 ± 0.05	

DERATING CURVE

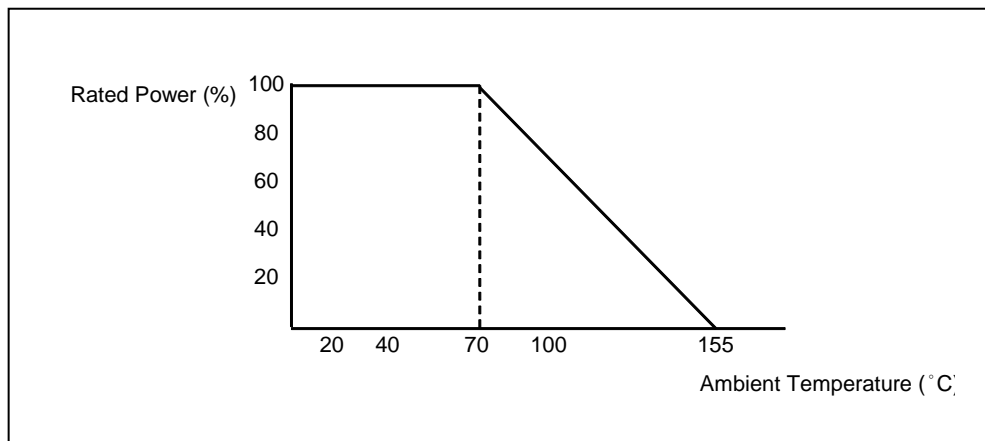

ELECTRICAL CHARACTERISTICS

CHARACTERISTICS	HHV-25	HHV50S	HHV-50	HHV1SS	HHV1WS	HHV2SS	HHV2WS	HHV3SS
Power Rating at 70 °C	1/4W	1/2W	1/2W	1W	1W	2W	2W	3W
Maximum Working Voltage(DC)	1,600V	1,600V	3,500V	3,500V	5,000V	5,000V	7,000V	7,000V
Maximum Overload Voltage(DC)	3,000V	3,000V	7,000V	7,000V	10,000V	10,000V	14,000V	14,000V
Voltage Proof on Insulation (Silicone Type)	300V	300V	500V	500V	600V	600V	600V	600V
Voltage Proof on Insulation (Epoxy Type)	500V	500V	500V	500V	700V	700V	700V	700V
Resistance Range	100KΩ ~ 68MΩ for E24 & E96 series value							
Operating Temp. Range	- 55°C to +155°C							
Temperature Coefficient	±200ppm/°C							

Note: For resistance value out of above range is by request.

TEST AND REQUIREMENTS

TEST	TEST METHOD	PROCEDURE	APPRAISE
Short Time Overload	IEC 60115-1 4.13	2.5 times RCWV for 5 sec.(Not more than maximum overload voltage)	±2.0%+0.05Ω
Voltage Proof on Insulation	IEC 60115-1 4.7	In V-Block for 60 sec. test voltage as above table	No Breakdown
Temperature Coefficient	IEC 60115-1 4.8	Between -55°C to +155°C	By Type
Insulation Resistance	IEC 60115-1 4.6	In V-Block for 60 sec.	>10,000MΩ
Solderability	IEC 60115-1 4.17	245±5°C for 3±0.5 Sec.	95% Min. coverage
Solvent Resistance of Marking	IEC 60115-1 4.30	IPA for 5±0.5 Min. with ultrasonic	No deterioration of coatings and markings
Robustness of Terminations	IEC 60115-1 4.16	Direct load for 10 Sec. in the direction of the terminal leads	≥2.5Kg(24.5N)
Periodic-pulse Overload	IEC 60115-1 4.39	4 times RCWV(or Umax., whichever less) 10,000 cycles (1 Sec. on, 25 Sec.off)	±1.0%+0.05Ω
Damp Heat Steady State	IEC 60115-1 4.24	40±2°C,90-95% RH for 56 days, loaded with 0.1 times RCWV(or Umax., whichever less)	±5.0%+0.05Ω
Endurance at 70°C	IEC 60115-1 4.25	70±2°C at RCWV(or Umax., whichever less) for 1,000 Hr.(1.5 Hr.on,0.5 Hr. off)	±5.0%+0.05Ω
Temperature Cycling	IEC 60115-1 4.19	-55°C → Room Temp. → +155°C → Room Temp.(5 cycles)	±1.0%+0.05Ω
Resistance to Soldering Heat	IEC 60115-1 4.18	260±3°C for 10±1 Sec., immersed to a point 3±0.5mm from the body	±1.0%+0.05Ω
Accidental Overload Test (Only for silicone lacquer type)	IEC 60115-1 4.26	4 times RCWV(or Umax., whichever less) for 1 Min.	No evidence of flaming or arcing

Note:.

RCWV (Rated Continuous Working Voltage):

The DC or AC (rms) continuous working voltage corresponding to the rated power is determined by the following formula:

$$V=\sqrt{(P \times R)}$$

or max. working voltage whichever is less

Where

V=Continuous rated DC or
AC (rms) working voltage (V)

P=Rated power (W)

R=Resistance value (Ω)

PULSE DIAGRAMS

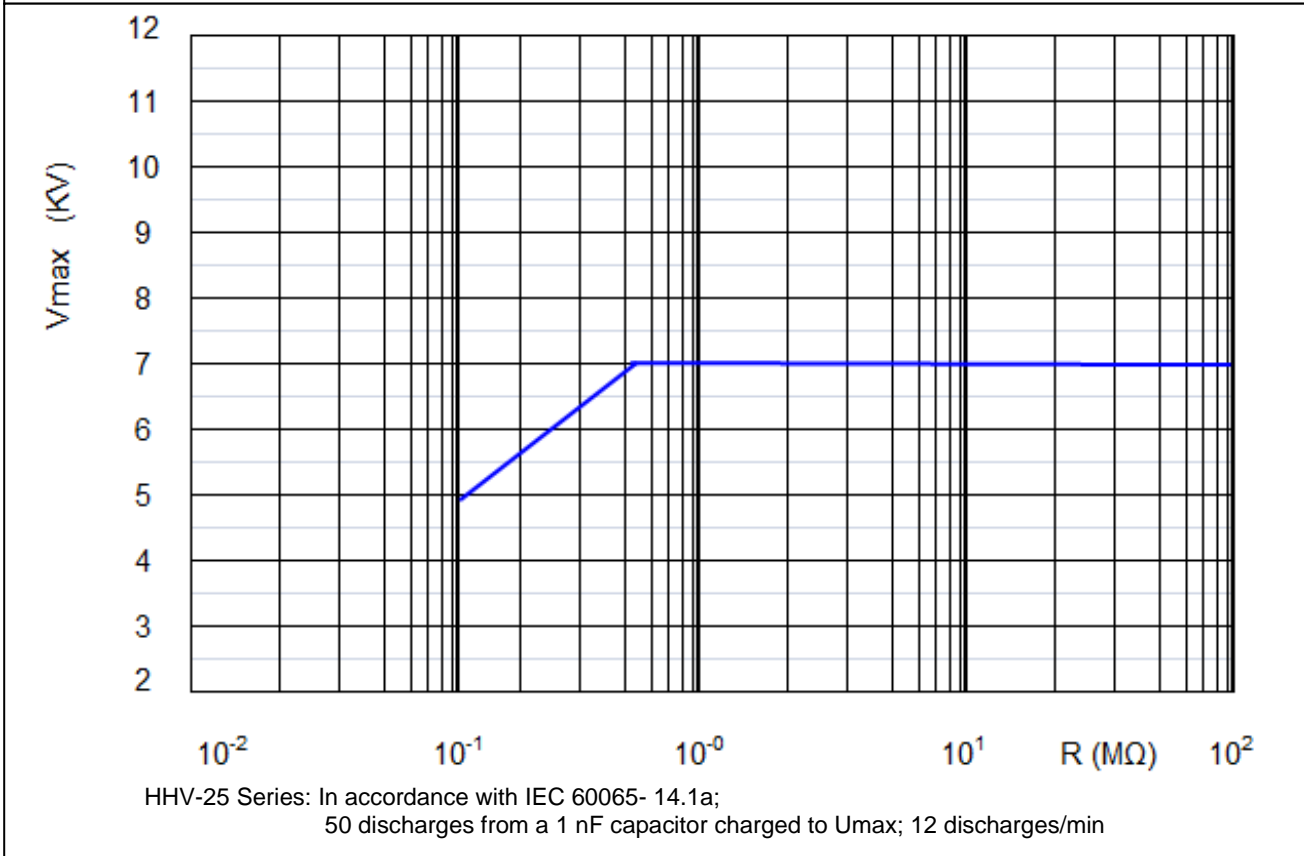
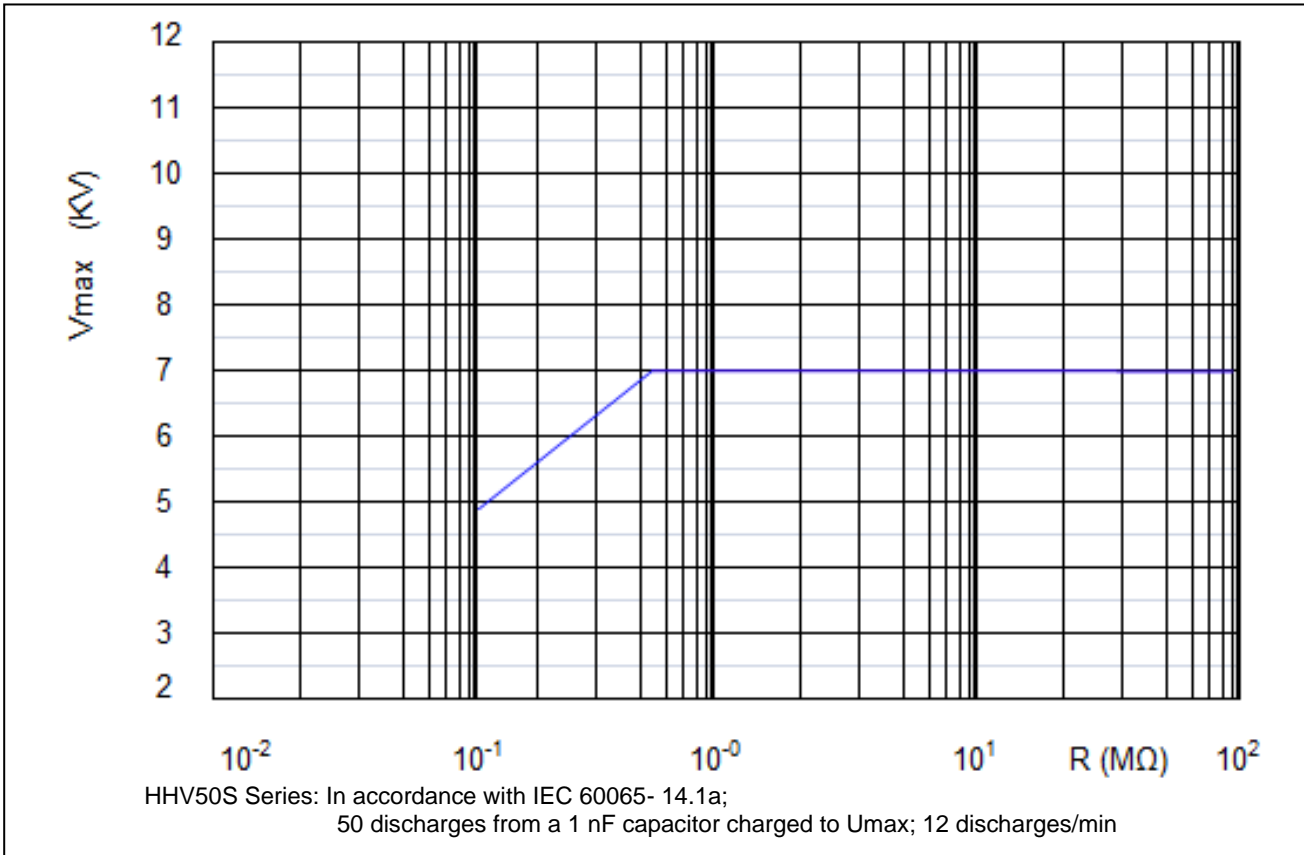

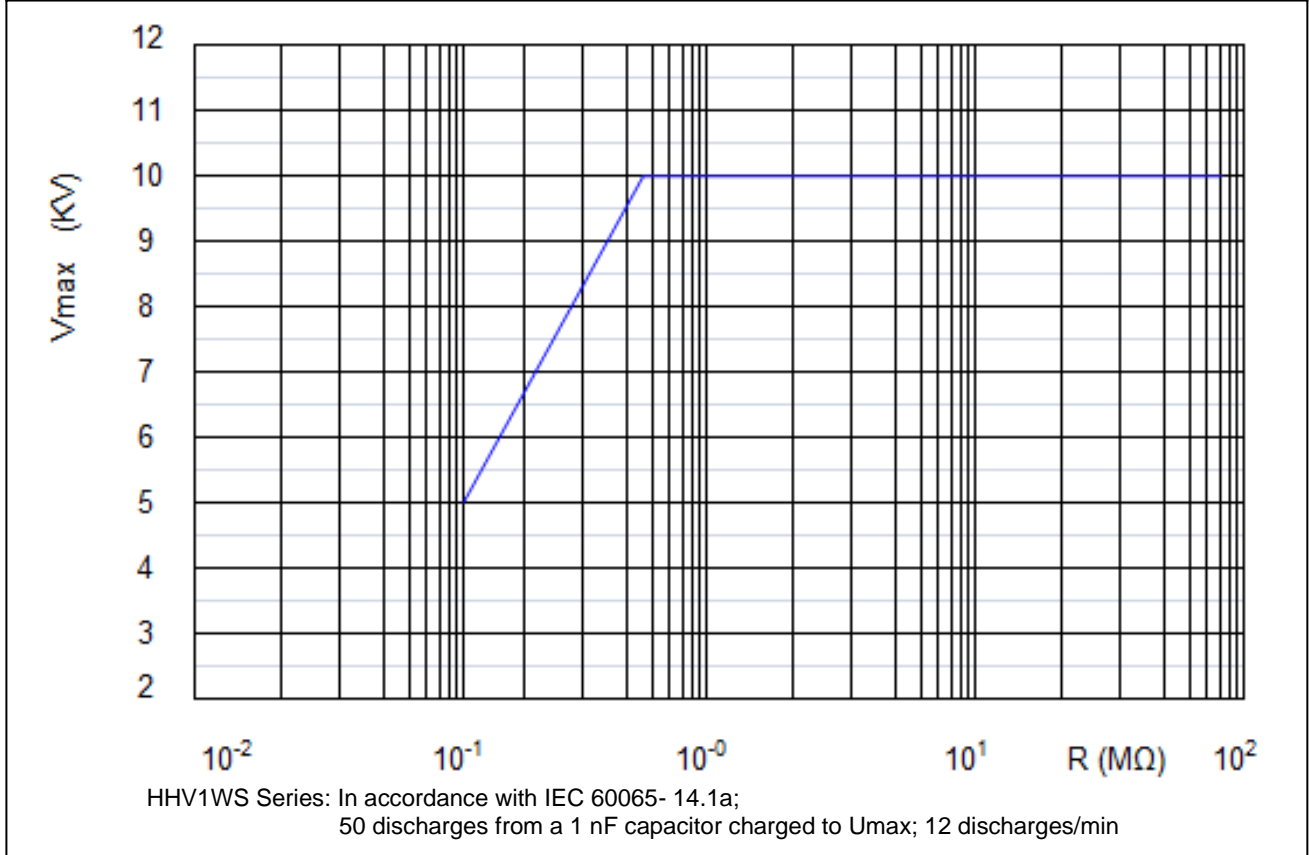
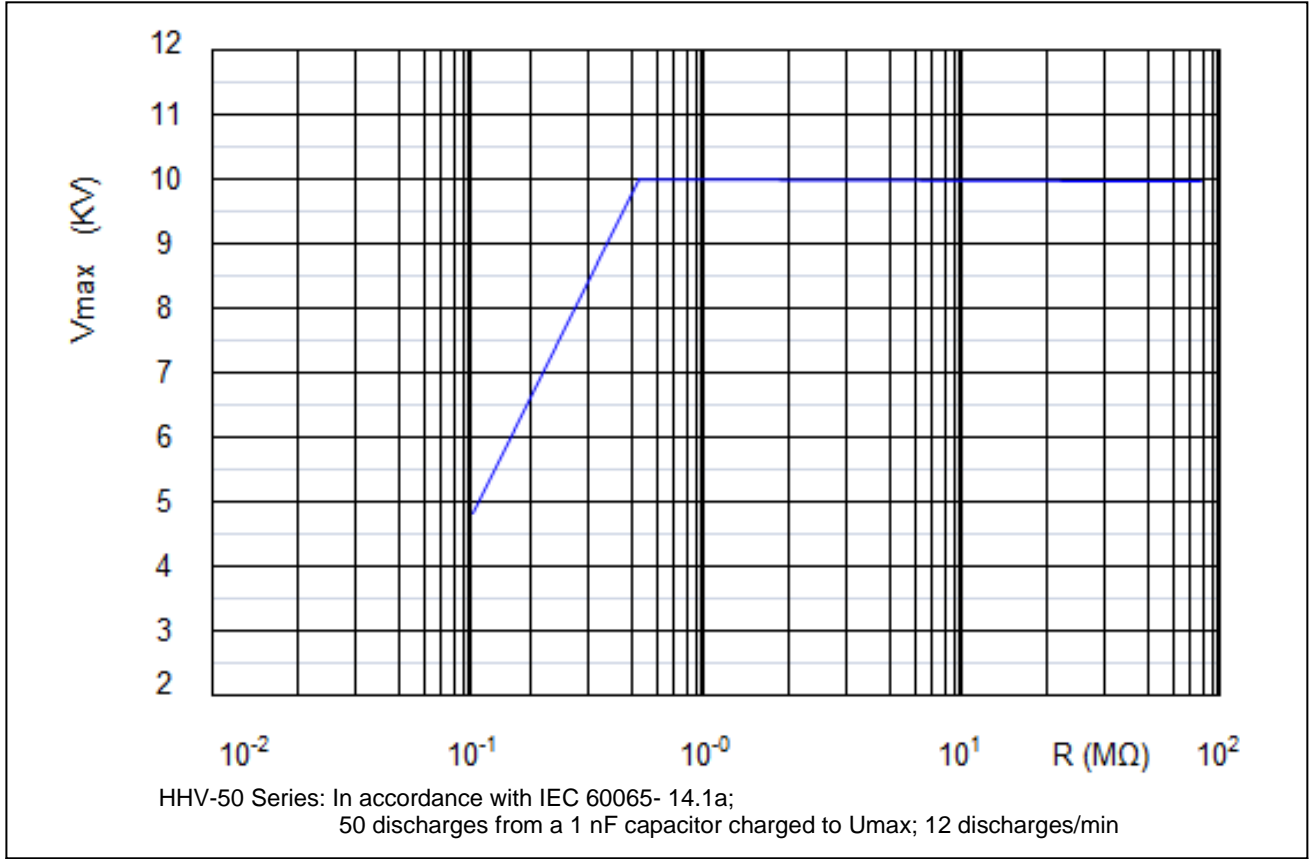

AXIAL / REEL TAPE SPECIFICATION

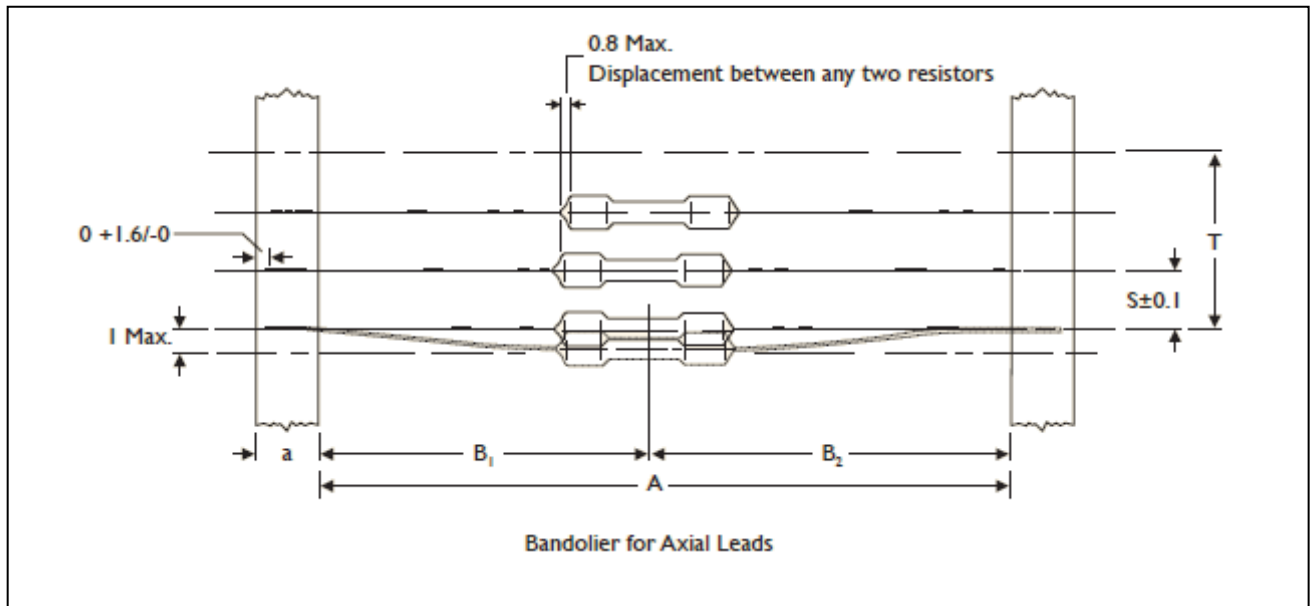

Unit: mm

Normal	Miniature	a	A	B1-B2 (Max.)	S (spacing)	T (max. deviation of spacing)
HHV-25	HHV50S	6 ± 0.5	52.4 ± 1.5	1.2	5	1 mm per 10 spacing, 0.5 mm per 5 spacing
			26.0 ± 1.5	1		
HHV-50	HHV1SS	6 ± 0.5	52.4 ± 1.5	1.2	5	
HHV1WS	HHV2SS	6 ± 0.5	73.0 ± 1.5	1.5	5	
			52.4 ± 1.5	1.2		
HHV2WS	HHV3SS	6 ± 0.5	73.0 ± 1.5	1.5	10	
			52.4 ± 1.5	1.2		

TAPE ON REEL PACKING

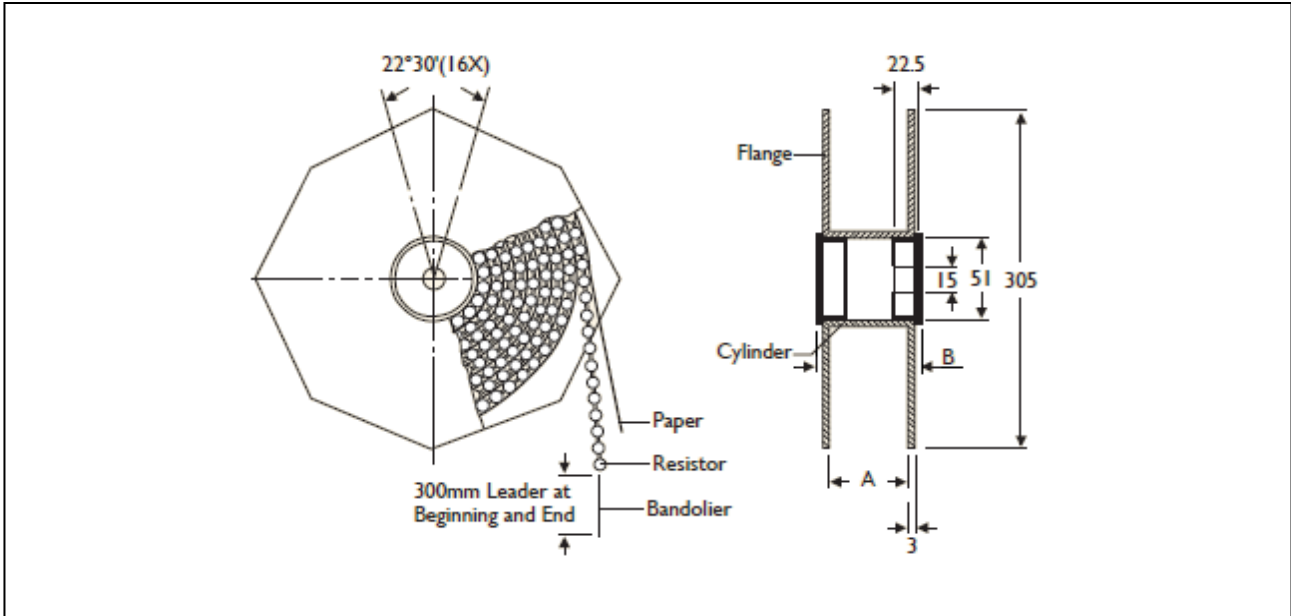

TYPE

Unit: mm/piece

Normal	Miniature	Across Flange(A)	B	Quantity Per Reel
HHV-25	HHV50S	40	49	5,000
HHV-25	HHV50S	66.5	75.5	5,000
HHV-50	HHV1SS	66.5	75.5	2,500
HHV1WS	HHV2SS	87	96	2,000
HHV2WS	HHV3SS	87	96	1,000

TAPE ON BOX PACKING

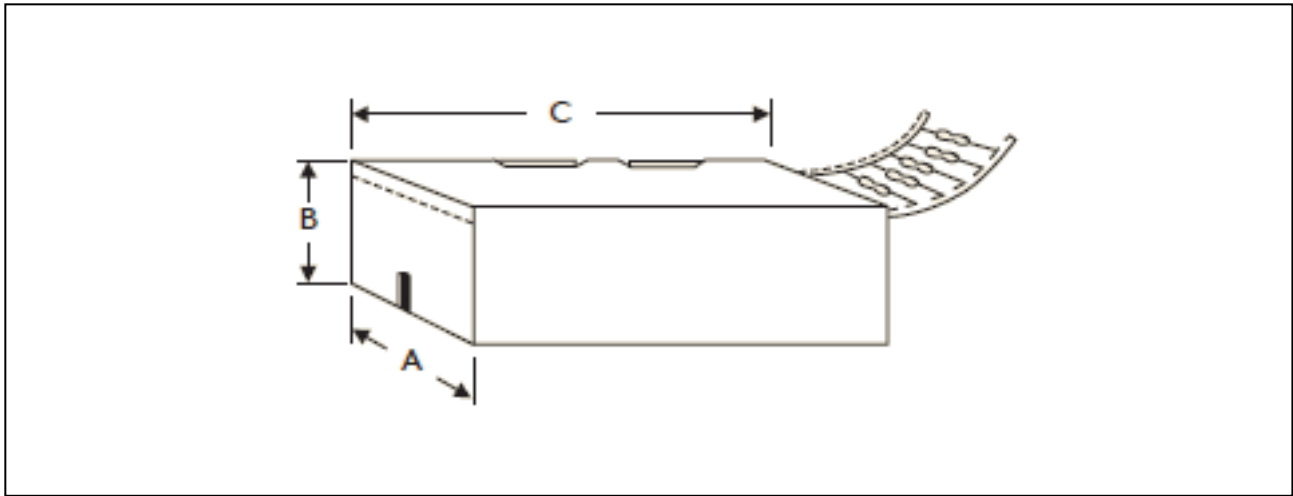

TYPE		DIMENSIONS			Unit: mm/piece
Normal	Miniature	A	B	C	Quantity Per Box
HHV-25	HHV50S	48	102	255	5,000
HHV-25	HHV50S	81	104	260	5,000
HHV-50	HHV1SS	73	45	258	1,000
HHV1WS	HHV2SS	81	91	260	1,000
HHV1WS	HHV2SS	103	78	260	1,000
HHV2WS	HHV3SS	81	91	260	1,000
HHV2WS	HHV3SS	103	94	260	1,000

BULK PACKING

Normal	Miniature	Piece/Per Inner Box	Bag/Per Inner Box	Piece Per Bag
HHV-25	HHV50S	10,000	10	1,000
HHV-50	HHV1SS	5,000	5	1,000
HHV1WS	HHV2SS	2,000	4	500
HHV2WS	HHV3SS	1,000	2	500

FORMING

M TYPE

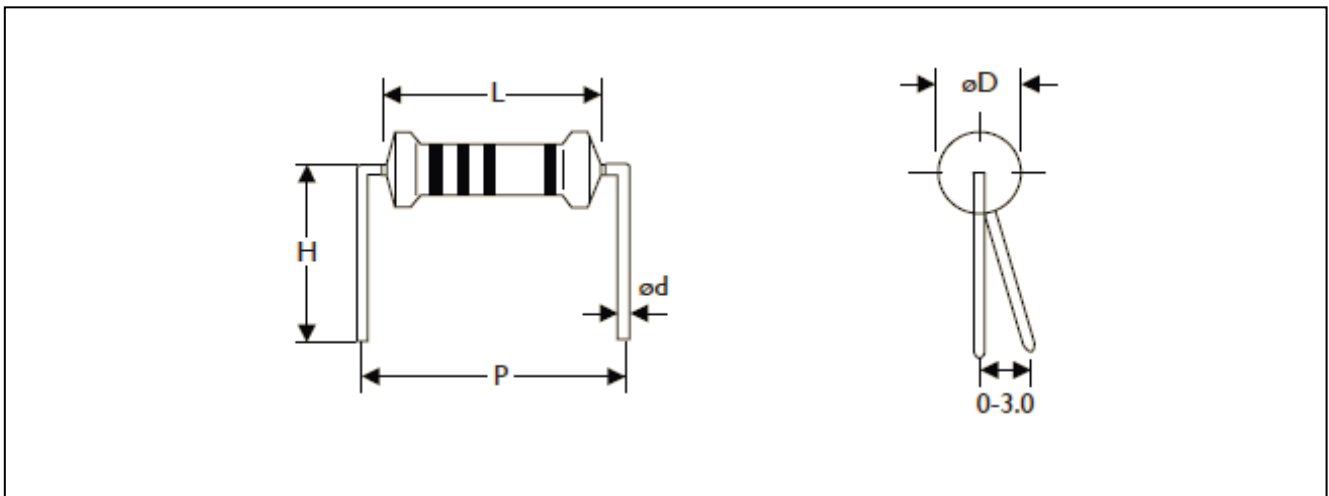

TYPE		DIMENSIONS					Unit: mm	
Normal	Miniature	L	ψD	ψd	P	H		
HHV-25	HHV50S	6.3 ± 0.5	2.4 ± 0.2	0.55 ± 0.05	10.0 ± 1	10.0 ± 1		
HHV-50	HHV1SS	9.0 ± 0.5	3.3 ± 0.3	0.55 ± 0.05	12.5 ± 1	10.0 ± 1		
HHV1WS	HHV2SS	11.5 ± 1.0	4.5 ± 0.5	0.8 ± 0.05	15.0 ± 1	12.5 ± 1		
HHV2WS	HHV3SS	15.5 ± 1.0	5.0 ± 0.5	0.8 ± 0.05	20.0 ± 1	15.0 ± 1		

MB TYPE

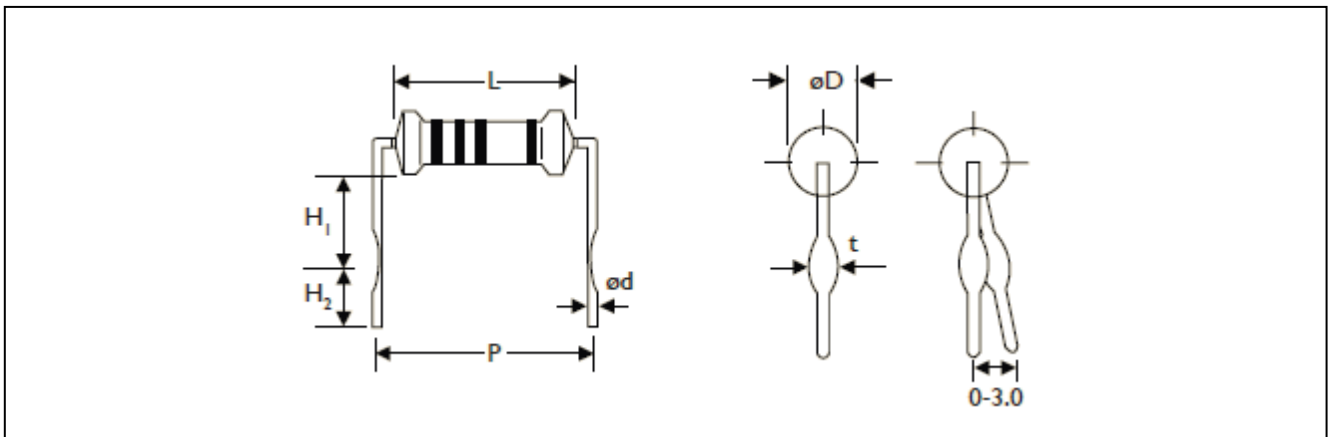

TYPE		DIMENSIONS							Unit: mm	
Normal	Miniature	L	ψD	ψd	P	H1	H2	t		
HHV-25	HHV50S	6.3 ± 0.5	2.4 ± 0.2	0.55 ± 0.05	10.0 ± 1	6.0 ± 1	5.0 ± 1	1.2 ± 0.2		
HHV-50	-	9.0 ± 0.5	3.3 ± 0.3	0.55 ± 0.05	12.5 ± 1	6.0 ± 1	5.0 ± 1	1.2 ± 0.2		
-	HHV1SS	9.0 ± 0.5	3.3 ± 0.3	0.8 ± 0.05	12.5 ± 1	6.0 ± 1	5.0 ± 1	1.4 ± 0.2		
HHV1WS	HHV2SS	11.5 ± 1.0	4.5 ± 0.5	0.8 ± 0.05	15.0 ± 1	6.0 ± 1	5.0 ± 1	1.4 ± 0.2		
HHV2WS	HHV3SS	15.5 ± 1.0	5.0 ± 0.5	0.8 ± 0.05	20.0 ± 1	10.0 ± 1	5.0 ± 1	1.4 ± 0.2		

MHA TYPE

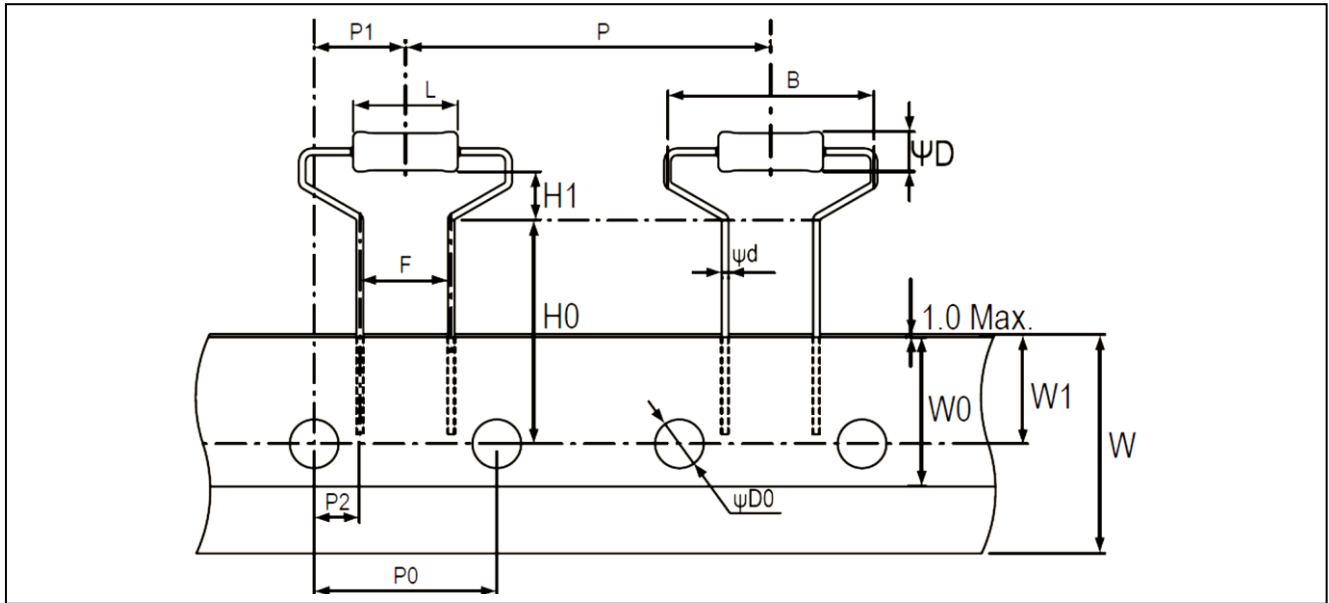

TYPE		DIMENSIONS								Unit: mm
Normal	Miniature	L	ψD	ψd	B	H0	H1	P	P0	
		9.0±0.5	3.3±0.3	0.55±0.05	17.5Max	19.0±1.0	4.0±1.0	30.0±1.0	15.0±0.3	
HHV-50	HHV1SS	P1	P2	F	W	W0	W1	$\psi D0$		
		7.5±1.0	3.75±0.5	7.5±0.5	18.0±0.5	5.0Min	9.0±0.5	4.0±0.2		

MHB TYPE

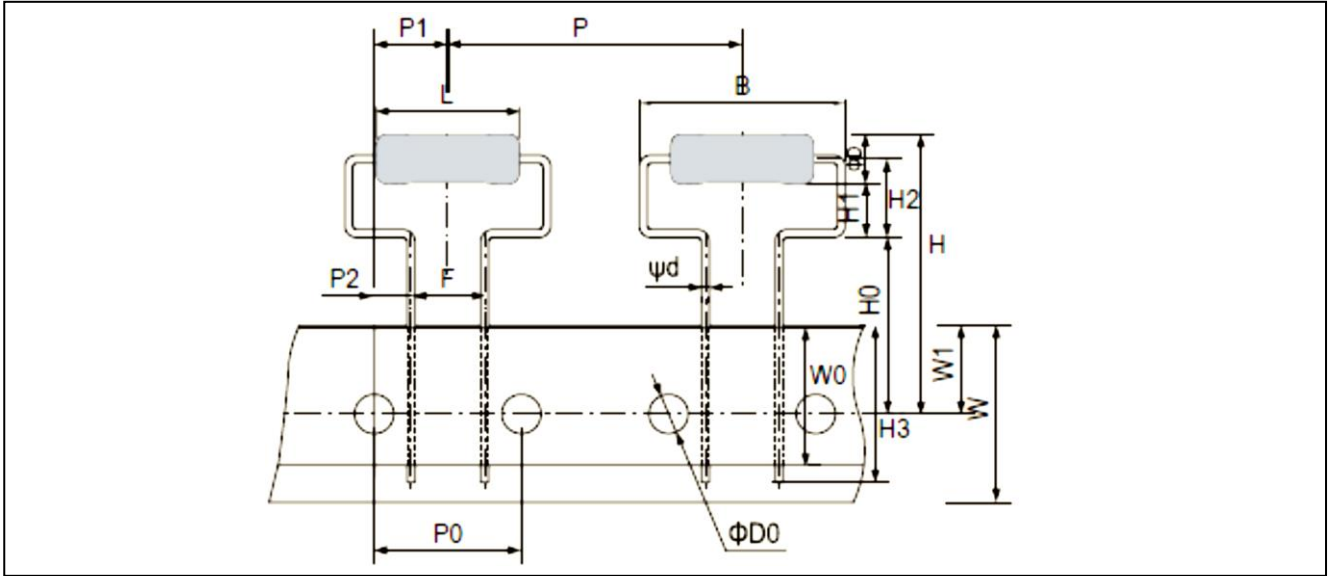

TYPE		DIMENSIONS									Unit: mm
Normal	Miniature	L	ψD	ψd	B	H	H0	H1	H2	H3	
		15.5±1.0	5.0±0.5	0.8±0.05	21.0Max.	30Max.	18.0±1.0	5.5(Ref.)	8.0±1.5	16Max.	
HHV2WS	HHV3SS	P	P0	P1	P2	F	W	W0	W1	ψD0	
		30.0±1.0	15.0±0.3	7.5±1.0	3.75±0.8	7.5±0.5	18.0±0.5	5.0Min.	9.0±0.5	4.0±0.3	

MHC TYPE

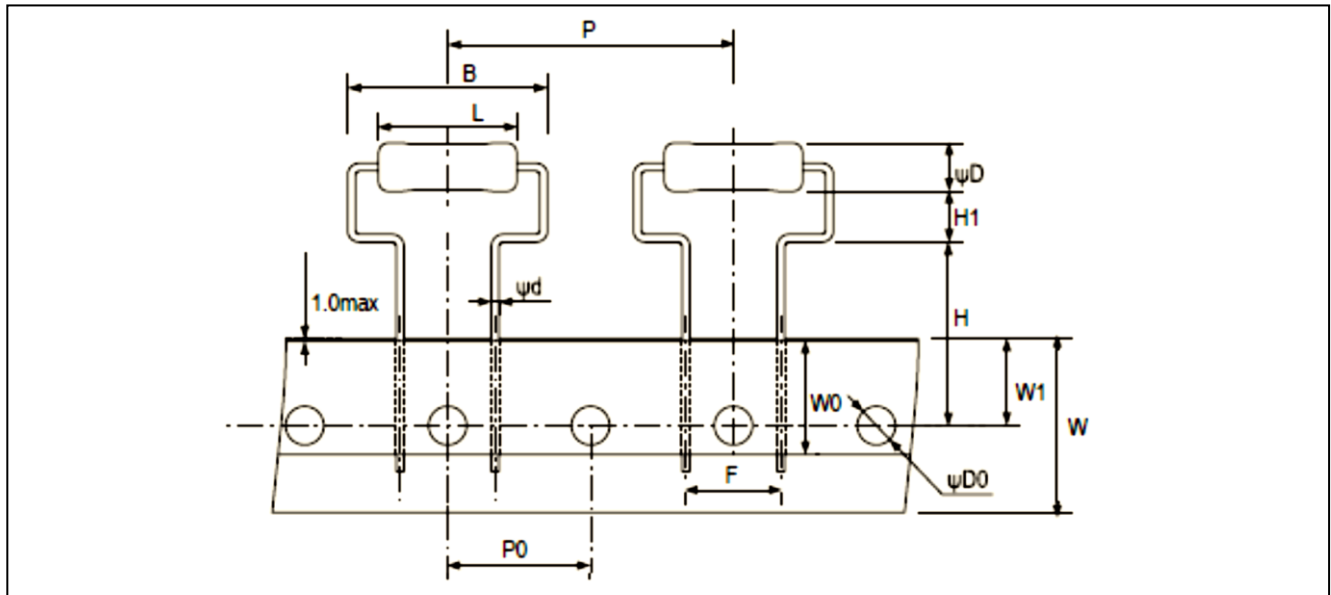

TYPE		DIMENSIONS									Unit: mm
Normal	Miniature	L	ψD	ψd	B	H	H1	P	P0		
		15.5±1.0	5.0±0.5	0.8±0.05	21.0Max.	19.0±1.0	5.25±1.0	30.0±1.0	15.0±0.3		
HHV2WS	HHV3SS	F	W	W0	W1	ψD0					
		10.0±0.5	18.0±0.5	5.0Min.	9.0±0.5	4.0±0.2					

F TYPE

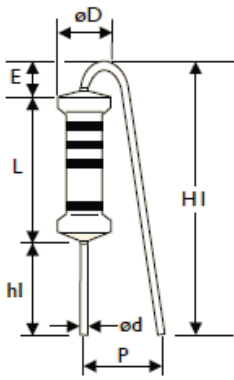

FK TYPE

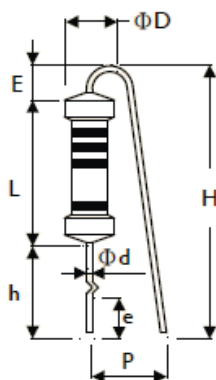

FFK TYPE

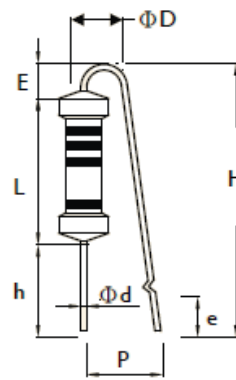

FKK TYPE

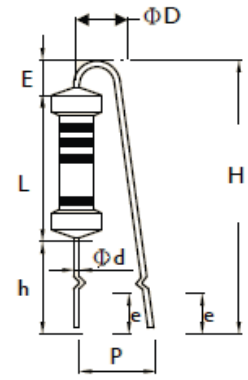

TYPE		DIMENSIONS										Unit: mm
Normal	Miniature	L	ψD	ψd	P	h	H Max.	hl	HI Max.	E Max.	e	
HHV-50	HHV1SS	9.0±0.5	3.3±0.3	0.55±0.05	6±1	8±1	22	5±1	18.5	3.5	3.5±1	
HHV1WS	HHV2SS	11.5±1	4.5±0.5	0.8±0.05	6±1	8±1	24	5±1	20	3.5	3.5±1	
HHV2WS	HHV3SS	15.5±1	5.0±0.5	0.8±0.05	8±1	8±1	28	5±1	25	3.5	3.5±1	

FB- TYPE (for -25&50S)

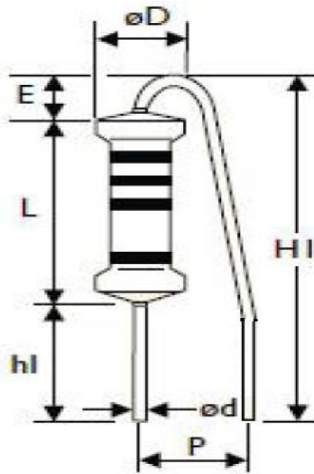

TYPE		DIMENSIONS							Unit: mm
Normal	Miniature	L	ψD	ψd	P	hl	HI	E Max.	
HHV-25	HHV50S	6.3 ± 0.5	2.4 ± 0.2	0.55 ± 0.05	6±1	5.5±0.5	13.5±0.5	3.5	

PN TYPE (Taping Pack)

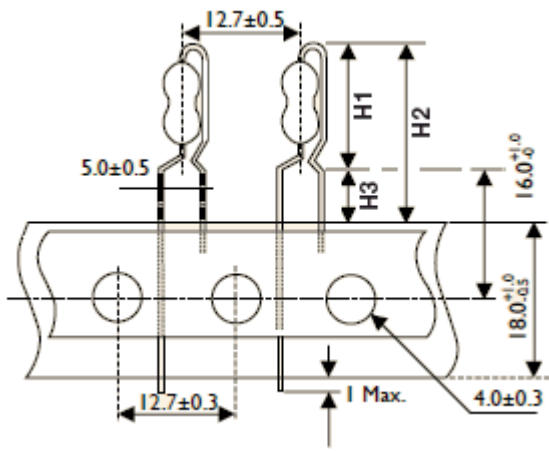

AV TYPE (Taping Pack)

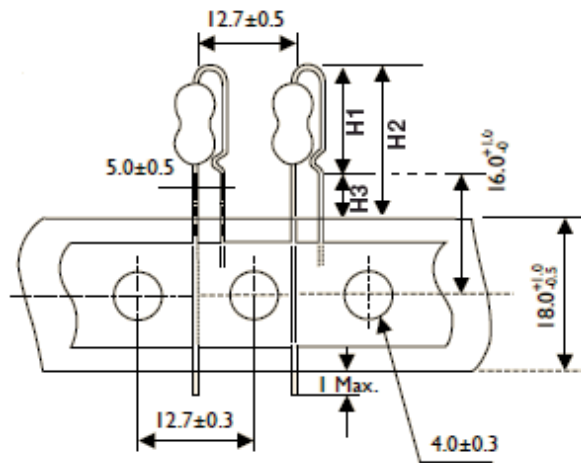

TYPE		DIMENSIONS			Unit: mm
Normal	Miniature	H1 Max.	H2 Max.	H3 Max.	
HHV-25	HHV50S	13	21.5	8.5	
HHV-50	HHV1SS	17	25.5	8.5	
HHV1WS	HHV2SS	19	27.5	8.5	

TYPE		DIMENSIONS			Unit: mm
Normal	Miniature	H1 Max.	H2 Max.	H3 Max.	
HHV-25	HHV50S	11.5	20	8.5	
HHV-50	HHV1SS	14.5	23	8.5	
HHV1WS	HHV2SS	17.5	26	8.5	

MARKING



COLOR	1st BAND	2nd BAND	3rd BAND	MULTIPLIER	TOLERANCE
BLACK	0	0	0	1Ω	
BROWN	1	1	1	10Ω	± 1 % (F)
RED	2	2	2	100Ω	
ORANGE	3	3	3	1KΩ	
YELLOW	4	4	4	10KΩ	HHV Series
GREEN	5	5	5	100KΩ	
BLUE	6	6	6	1MΩ	
VIOLET	7	7	7	10MΩ	
GREY	8	8	8		
WHITE	9	9	9		
GOLD				0.1Ω	± 5 % (J)
SILVER				0.01Ω	

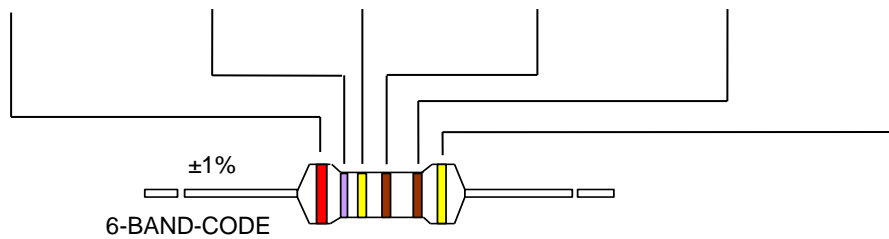

REVISION HISTORY

REVISION	DATE	CHANGE NOTIFICATION	DESCRIPTION
Version 2	Sep.5, 2023	-	- Update legal disclaimer and footer version numbers
Version 1	Aug.31, 2022	-	- Add FB- forming code to -25&50S
Version 0	Aug.2, 2021	-	- First issue of this specification

“ Yageo reserves all the rights for revising the content of this datasheet without further notification, as long as the products itse lf are unchanged. Any product change will be announced by PCN.”

LEGAL DISCLAIMER

YAGEO, its distributors and agents (collectively, "YAGEO"), hereby disclaims any and all liabilities for any errors, inaccuracies or incompleteness contained in any product related information, including but not limited to product specifications, datasheets, pictures and/or graphics. YAGEO may make changes, modifications and/or improvements to product related information at any time and without notice.

YAGEO makes no representation, warranty, and/or guarantee about the fitness of its products for any particular purpose or the continuing production of any of its products. To the maximum extent permitted by law, YAGEO disclaims (i) any and all liability arising out of the application or use of any YAGEO product, (ii) any and all liability, including without limitation special, consequential or incidental damages, and (iii) any and all implied warranties, including warranties of fitness for a particular purpose, non-infringement and merchantability.

YAGEO products are designed for general purpose applications under normal operation and usage conditions. Please contact YAGEO for the applications listed below which require especially high reliability for the prevention of defects which might directly cause damage to the third party's life, body or property: Aerospace equipment (artificial satellite, rocket, etc.), Atomic energy-related equipment, Aviation equipment, Disaster prevention equipment, crime prevention equipment, Electric heating apparatus, burning equipment, Highly public information network equipment, data-processing equipment, Medical devices, Military equipment, Power generation control equipment, Safety equipment, Traffic signal equipment, Transportation equipment and Undersea equipment, or for any other application or use in which the failure of YAGEO products could result in personal injury or death, or serious property damage. Particularly **YAGEO Corporation and its affiliates do not recommend the use of commercial or automotive grade products for high reliability applications or manned space flight.**

Information provided here is intended to indicate product specifications only. YAGEO reserves all the rights for revising this content without further notification, as long as products are unchanged. Any product change will be announced by PCN.