

IP65 Diecast Aluminium Enclosure 90 x 36 x 30mm



DESCRIPTION

A sealed die cast aluminium enclosure with a natural aluminium finish.

DISTINCTIVE FEATURES

- Manufactured from ADC-12 aluminium
- Recessed channel in lids for neoprene gasket
- Lid secured via countersunk screw holes
- Wall mounting holes
- Supplied with lid and fixing screws
- Nominal wall thickness 3.3mm
- Sealed to IP65 and NEMA4 (dust and hoseproof)

APPLICATIONS

General purpose diecast Aluminium enclosures for a variety of industrial, automotive or commercial uses. Suitable for robust applications in outdoor environments. Designed to meet IP65 to protect against dust ingress and water spray.

IP65

NEMA4

ADC-12
Aluminium

⊕
Screws



GENERAL SPECIFICATION

Series	IP65 Diecast Aluminium Enclosures
Type	General Purpose Enclosure
Screws	Qty 4 \oplus M4x 20 mm
Weight	109g



MATERIALS

Material	ADC-12 aluminium
Finish	Brushed
Colour	Natural Aluminium
Screws	Stainless Steel
Gasket	EPDM



ENVIRONMENTAL/OPERATING SPECIFICATION

IP Rating	Enclosures are designed to meet the requirements of IP65
Operating Temperature	40°C to +120°C



DIMENSIONS/DRAWINGS

Dimensions	mm
------------	----

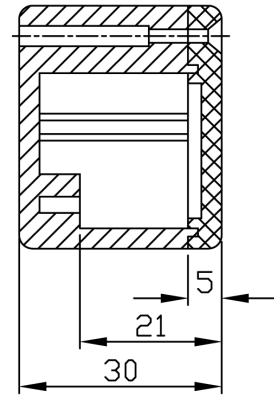
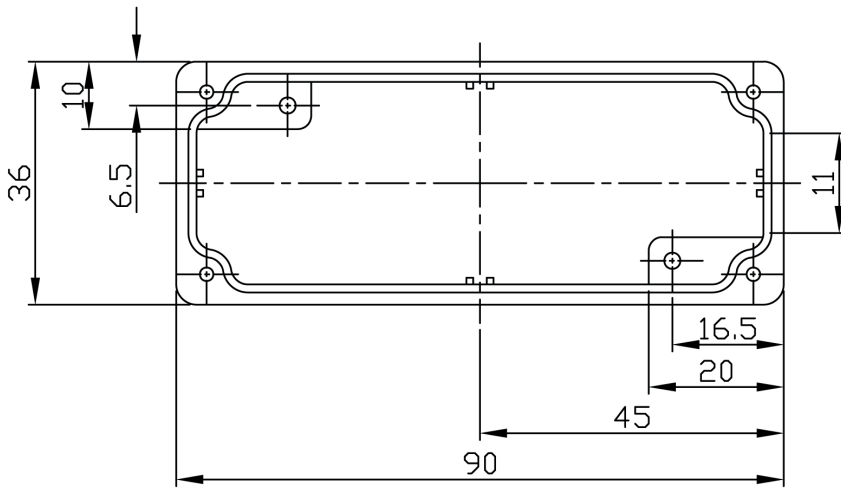
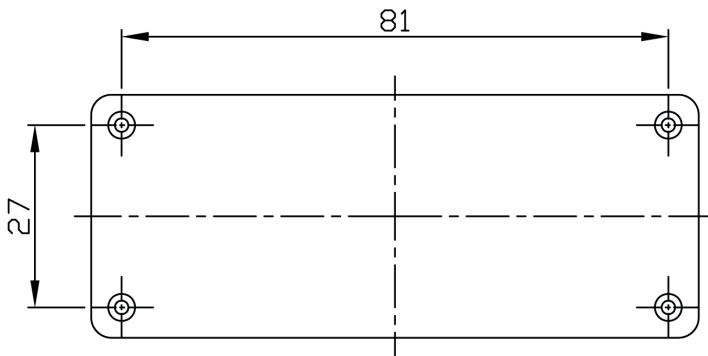

PART NUMBER TABLE

Part Number	EAN	UNSPSC	Country of Origin
30-4251	5053556001811	39121324	Taiwan

R-TECH

Tried & trusted technology

Important Notice: This data sheet and its contents (the "Information") belong to Rapid Electronics Limited or are licensed to it. No licence is granted for the use of it other than for information purposes in connection with the products to which it relates. No licence of any intellectual property rights is granted. The Information is subject to change without notice and replaces all data sheets previously supplied. The Information supplied is believed to be accurate but Rapid Electronics Limited assumes no responsibility for its accuracy or completeness, any error in or omission from it or for any use made of it. Users of this data sheet should check for themselves the Information and the suitability of the products for their purpose and not make any assumptions based on information included or omitted. Liability for loss or damage resulting from any reliance on the Information or use of it (including liability resulting from negligence or where Rapid Electronics Limited were aware of the possibility of such loss or damage arising) is excluded. This will not operate to limit or restrict Rapid Electronics Limited's liability for death or personal injury resulting from its negligence.