

M12MALE 90° / M12FEMALE 90° B-CODED INTERBUS

PUR 3x2x0.25 shielded violet 5m

Interbus, B-coded
 Male 90° to female 90°
 M12 - M12
 5-pole, shielded

Further cable lengths on request. Plastic housings with good resistance against chemicals and oils. The resistance to aggressive media should be individually tested for your application. Further details on request.

[Link to Product](#)

Illustration

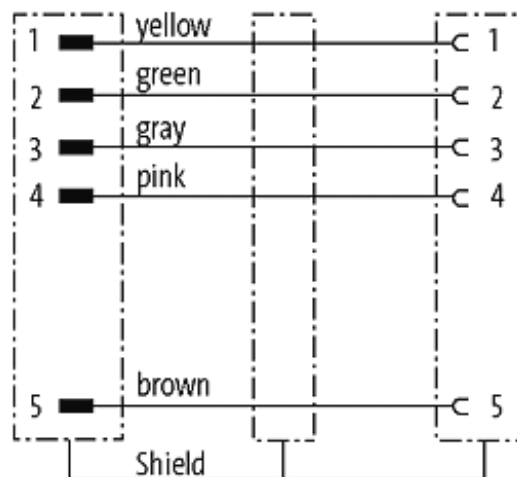

Male

Female



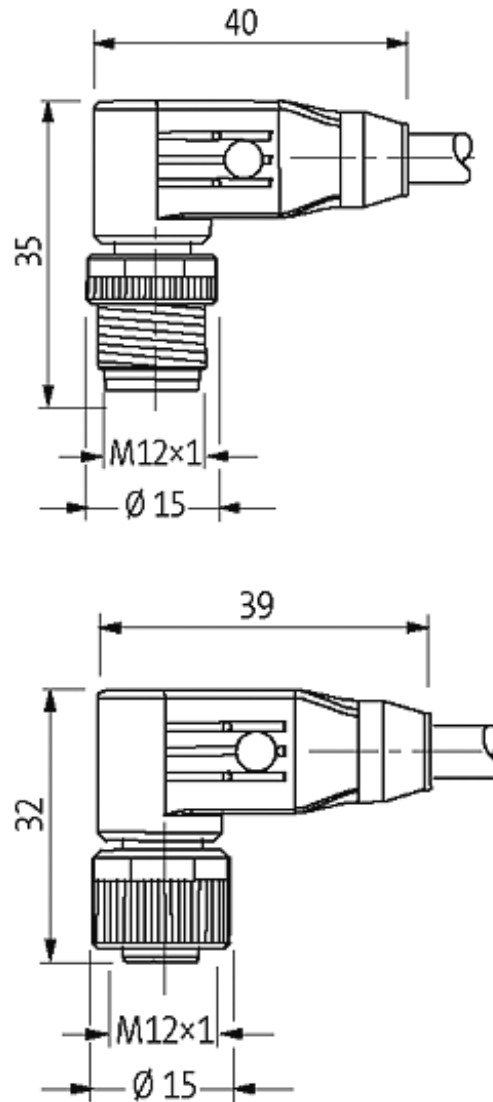

Product may differ from Image

Approvals



Form

44061

Technical Data

Operating voltage	60 V AC/DC
Operating current per contact	max. 4 A
Protection	IP65 and IP67 when plugged and screwed down (EN 60529)
Locking of ports	Screw thread M12 × 1 mm (recommended torque 0.6 Nm) self-securing

Cables

Cable number 799

No./diameter of wires	3 × 2 × (AWG 24)
Wire isolation	PE (br,wh,gr,pk,gn,ye)
C-track properties	2 Mio.
Jacket Color	violet
Shore hardness outer jacket	85 ± 5A
Material (jacket)	PUR
Outer diameter	approx. 7.7 mm
Bend radius (fixed)	10 × outer Ø
Bend radius (moving)	15 × outer Ø
Temperature range (fixed)	-40...+70 °C
Temperature range (mobile)	-20...+50 °C
Shielded	yes

Commercial data

country of origin	DE
customs tariff number	85444290
minimum order quantity	10