

STAR-DELTA CONT. ASSY. AC3:75KW/400V 230 V AC 50/60 HZ
 SIZE S3, SCREW TERMINALS ELEC. AND MECH. INTERLO.
 3NO+3NC



Figure similar

Product brand name	SIRIUS
Product designation	Contacteur assembly for star-delta (wye-delta) start
Product type designation	3RA24
Manufacturer's article number	<ul style="list-style-type: none"> • 1 of the supplied contactor 3RT2045-1AP00 • 2 of the supplied contactor 3RT2045-1AP00 • 3 of the supplied contactor 3RT2036-1AP00 • of the supplied RS assembly kit 3RA2943-2C • of the supplied function module for wye-delta circuits 3RA2816-0EW20

General technical data	
Size of contactor	S3
Product extension	No
<ul style="list-style-type: none"> • Auxiliary switch 	
Insulation voltage	690 V
<ul style="list-style-type: none"> • with degree of pollution 3 rated value 	
Degree of pollution	3

Surge voltage resistance rated value	6 kV
Protection class IP	
• on the front	IP20
Shock resistance at rectangular impulse	
• at AC	6.7 g / 5 ms, 4.0 g / 10 ms
Shock resistance with sine pulse	
• at AC	10.6 g / 5 ms, 6.3 g / 10 ms
Mechanical service life (switching cycles)	
• of contactor typical	10 000 000
• of the contactor with added auxiliary switch block typical	10 000 000
Equipment marking	
• acc. to DIN EN 81346-2	Q

Ambient conditions

Installation altitude at height above sea level	
• maximum	2 000 m
Ambient temperature	
• during operation	-25 ... +60 °C
• during storage	-55 ... +80 °C

Main circuit

Number of poles for main current circuit	3
Number of NO contacts for main contacts	3
Number of NC contacts for main contacts	0
Operating voltage	
• at AC-3 rated value maximum	690 V
Operating current	
• at AC-1 at 400 V	
— at ambient temperature 40 °C rated value	125 A
— at ambient temperature 60 °C rated value	105 A
Operating frequency	
• at AC-1 maximum	900 1/h
• at AC-2 maximum	400 1/h
• at AC-3 maximum	1 000 1/h
• at AC-4 maximum	300 1/h

Control circuit/ Control

Type of voltage of the control supply voltage	AC
Control supply voltage 1 at AC	
• at 50 Hz rated value	230 V
Operating range factor control supply voltage rated value of magnet coil at AC	
• at 50 Hz	0.8 ... 1.1

<ul style="list-style-type: none"> • at 60 Hz 	0.85 ... 1.1
Apparent pick-up power of magnet coil at AC	
<ul style="list-style-type: none"> • at 50 Hz • at 60 Hz 	348 V·A 296 V·A
Inductive power factor with closing power of the coil	
<ul style="list-style-type: none"> • at 50 Hz • at 60 Hz 	0.62 0.55
Apparent holding power of magnet coil at AC	
<ul style="list-style-type: none"> • at 50 Hz • at 60 Hz 	25 V·A 18 V·A
Inductive power factor with the holding power of the coil	
<ul style="list-style-type: none"> • at 50 Hz • at 60 Hz 	0.35 0.41

Auxiliary circuit

Number of NC contacts	
<ul style="list-style-type: none"> • for auxiliary contacts <ul style="list-style-type: none"> — instantaneous contact 	3
Number of NO contacts	
<ul style="list-style-type: none"> • for auxiliary contacts <ul style="list-style-type: none"> — instantaneous contact 	3
Operating current of auxiliary contacts at AC-12 maximum	10 A
Operating current of auxiliary contacts at AC-15	
<ul style="list-style-type: none"> • at 230 V • at 400 V 	6 A 3 A
Operating current of auxiliary contacts at DC-13	
<ul style="list-style-type: none"> • at 24 V • at 60 V • at 110 V • at 220 V 	10 A 2 A 1 A 0.3 A

UL/CSA ratings

Contact rating of auxiliary contacts according to UL	A600 / Q600
---	-------------

Short-circuit protection

Design of the fuse link	
<ul style="list-style-type: none"> • for short-circuit protection of the main circuit <ul style="list-style-type: none"> — with type of coordination 1 required — with type of assignment 2 required • for short-circuit protection of the auxiliary switch required 	gG NH 3NA, DIAZED 5SB, NEOZED 5SE: 250 A gG NH 3NA, DIAZED 5SB, NEOZED 5SE: 160 A fuse gG: 10 A

Installation/ mounting/ dimensions

Mounting position	+/-180° rotation possible on vertical mounting surface; can be tilted forward and backward by +/- 22.5° on vertical mounting surface
Mounting type	screw and snap-on mounting onto 35 mm standard mounting rail
Height	180 mm
Width	220 mm
Depth	244 mm
Required spacing	
<ul style="list-style-type: none"> • with side-by-side mounting <ul style="list-style-type: none"> — forwards 10 mm — Backwards 0 mm — upwards 10 mm — downwards 10 mm — at the side 10 mm • for grounded parts <ul style="list-style-type: none"> — forwards 10 mm — Backwards 0 mm — upwards 10 mm — at the side 10 mm — downwards 10 mm • for live parts <ul style="list-style-type: none"> — forwards 10 mm — Backwards 0 mm — upwards 10 mm — downwards 10 mm — at the side 10 mm 	

Connections/Terminals

Type of electrical connection	
<ul style="list-style-type: none"> • for main current circuit • for auxiliary and control current circuit 	<p>screw-type terminals</p> <p>screw-type terminals</p>
Type of connectable conductor cross-sections	
<ul style="list-style-type: none"> • for main contacts <ul style="list-style-type: none"> — single or multi-stranded — finely stranded with core end processing — finely stranded without core end processing • at AWG conductors for main contacts 	<p>2x (2.5 ... 16 mm²), 2x (10 ... 50 mm²), 1x (10 ... 70 mm²)</p> <p>2x (2.5 ... 35 mm²), 1x (2.5 ... 50 mm²)</p> <p>2x (10 ... 35 mm²), 1x (10 ... 50 mm²)</p> <p>2x (10 ... 1/0), 1x (10 ... 2/0)</p>
Type of connectable conductor cross-sections	
<ul style="list-style-type: none"> • for auxiliary contacts <ul style="list-style-type: none"> — single or multi-stranded — finely stranded with core end processing • at AWG conductors for auxiliary contacts 	<p>2x (0,5 ... 1,5 mm²), 2x (0,75 ... 2,5 mm²)</p> <p>2x (0.5 ... 1.5 mm²), 2x (0.75 ... 2.5 mm²)</p> <p>2x (20 ... 16), 2x (18 ... 14)</p>





Safety related data

B10 value	
<ul style="list-style-type: none"> with high demand rate acc. to SN 31920 	1 000 000
Proportion of dangerous failures	
<ul style="list-style-type: none"> with low demand rate acc. to SN 31920 	40 %
<ul style="list-style-type: none"> with high demand rate acc. to SN 31920 	73 %
Failure rate [FIT]	
<ul style="list-style-type: none"> with low demand rate acc. to SN 31920 	100 FIT
T1 value for proof test interval or service life acc. to IEC 61508	20 y

Communication/ Protocol

Product function Bus communication	No
Protocol is supported	
<ul style="list-style-type: none"> AS-interface protocol 	No
Product function Control circuit interface with IO link	No

Certificates/approvals

General Product Approval	Declaration of Conformity	Marine / Shipping
	 EG-Konf.	 BUREAU VERITAS  GL  LRS  RMRS
Marine / Shipping	other	



[Confirmation](#)

Further information

Information- and Downloadcenter (Catalogs, Brochures,...)

<http://www.siemens.com/industrial-controls/catalogs>

Industry Mall (Online ordering system)

<https://mall.industry.siemens.com/mall/en/en/Catalog/product?mlfb=3RA2445-8XF32-1AP0>

Cax online generator

<http://support.automation.siemens.com/WW/CAXorder/default.aspx?lang=en&mlfb=3RA2445-8XF32-1AP0>

Service&Support (Manuals, Certificates, Characteristics, FAQs,...)

<https://support.industry.siemens.com/cs/ww/en/ps/3RA2445-8XF32-1AP0>

Image database (product images, 2D dimension drawings, 3D models, device circuit diagrams, EPLAN macros, ...)

http://www.automation.siemens.com/bilddb/cax_de.aspx?mlfb=3RA2445-8XF32-1AP0&lang=en

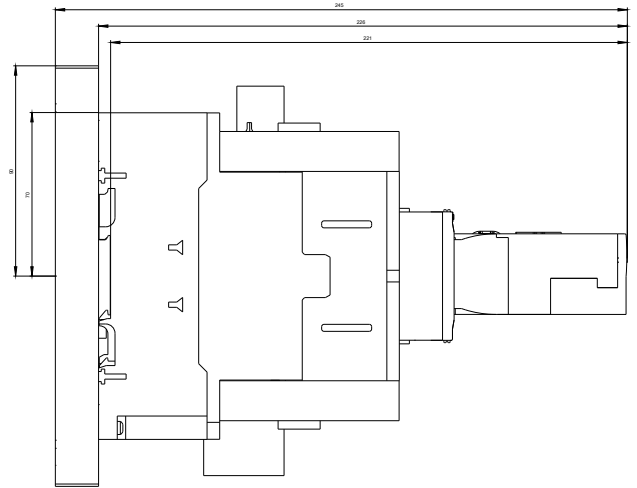
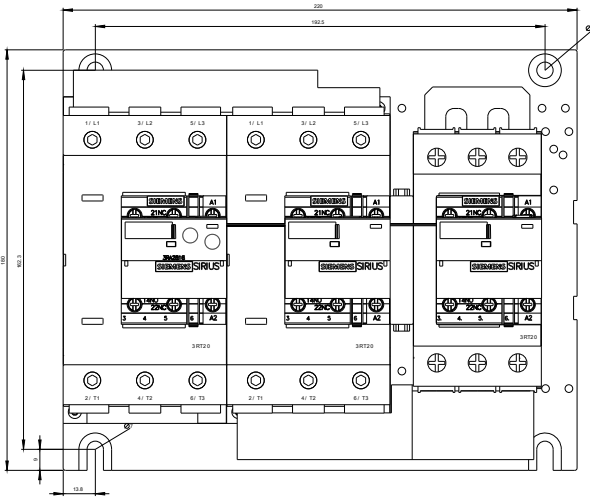

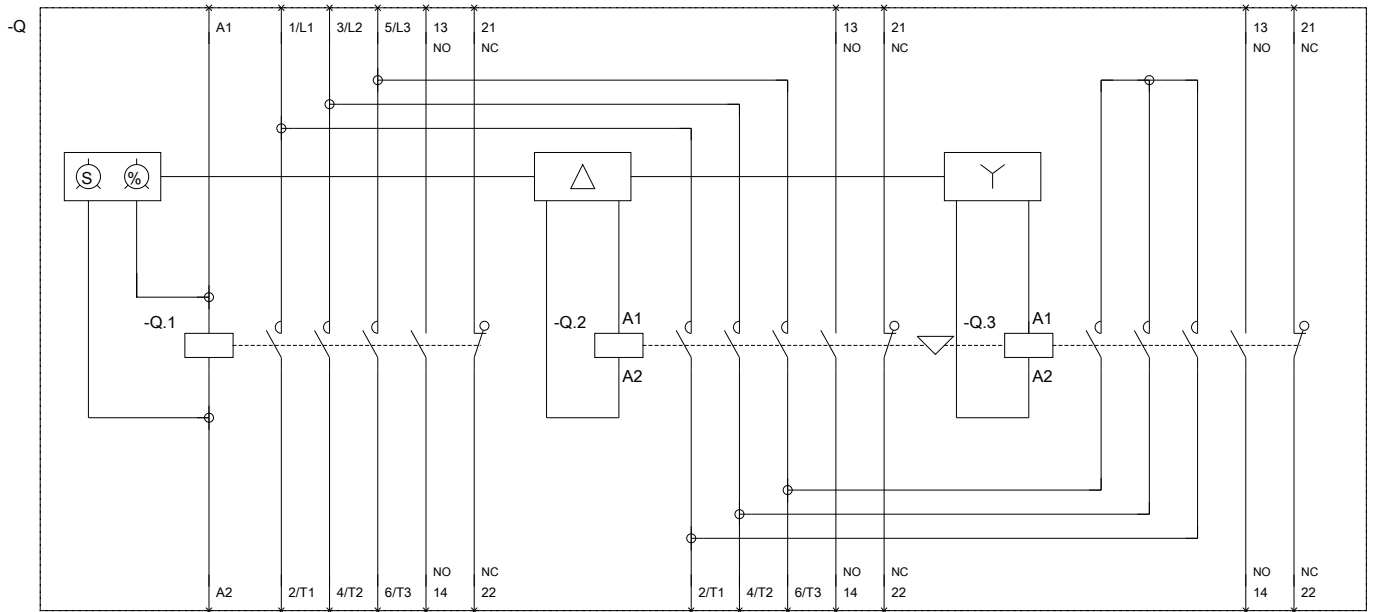

last modified:

10/13/2017