

Model	
Product brand name	SETRON
Product designation	Accessories
Design of the product	Retaining bracket
accessories	FIXING BRACKET

Mechanical Design	
Depth	67 mm

Certificates			
General Product Approval	EMC	Declaration of Conformity	other



[Miscellaneous](#)

Further information

Information- and Downloadcenter (Catalogs, Brochures,...)
<http://www.siemens.com/lowvoltage/catalogs>

Industry Mall (Online ordering system)

<https://mall.industry.siemens.com/mall/en/en/Catalog/product?mlfb=3VA9477-0GA80>

Service&Support (Manuals, Certificates, Characteristics, FAQs,...)

<https://support.industry.siemens.com/cs/ww/en/ps/3VA9477-0GA80>

Image database (product images, 2D dimension drawings, 3D models, device circuit diagrams, ...)

http://www.automation.siemens.com/bilddb/cax_en.aspx?mlfb=3VA9477-0GA80

CAX-Online-Generator

<http://www.siemens.com/cax>

Tender specifications

<http://www.siemens.com/specifications>

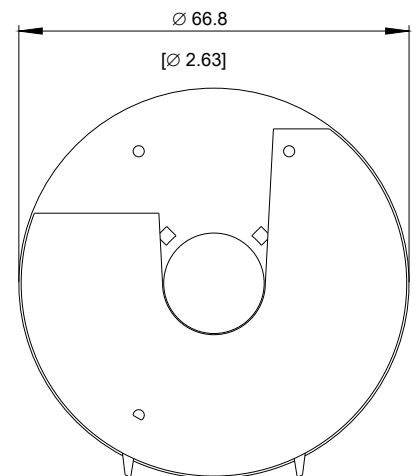
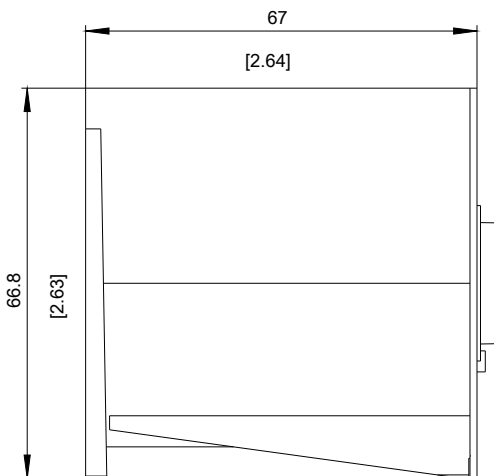

last modified:

08/28/2017