

REAR INSULATINGPLATE BROADENED 1 PCS.  
ACCESSORY FOR: 3VA2 400/630



Figure similar

## Model

product brand name SENTRON

General Product Approval	EMC	Declaration of Conformity	other
--------------------------	-----	---------------------------	-------



[other](#)



EG-Konf.

[other](#)

## Further information

**Information- and Downloadcenter (Catalogs, Brochures,...)**

<http://www.siemens.com/lowvoltage/catalogs>

**Industry Mall (Online ordering system)**

<https://eb.automation.siemens.com/mall/en/WW/Catalog/Product/3VA94810WK40>

**Service&Support (Manuals, Certificates, Characteristics, FAQs,...)**

<http://support.automation.siemens.com/WW/view/en/3VA94810WK40/all>

**Image database (product images, 2D dimension drawings, 3D models, device circuit diagrams, ...)**

[http://www.automation.siemens.com/bilddb/cax\\_en.aspx?mlfb=3VA94810WK40](http://www.automation.siemens.com/bilddb/cax_en.aspx?mlfb=3VA94810WK40)

**CAX-Online-Generator**

<http://www.siemens.com/cax>

**Tender specifications**

<http://ausschreibungstexte.siemens.com/tiplv>

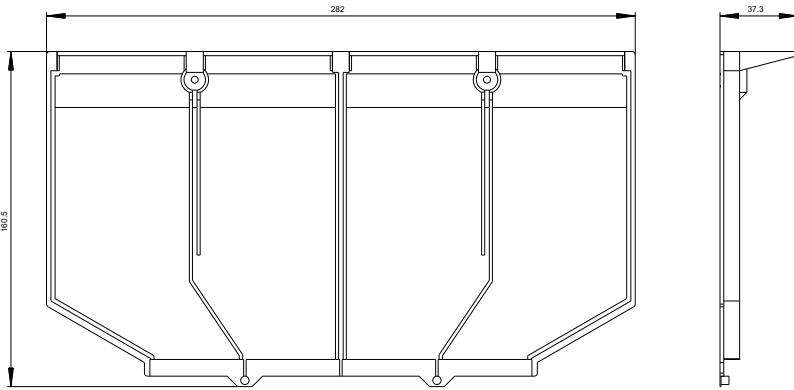

last modified:

11.03.2015