

Thermocouple Connector

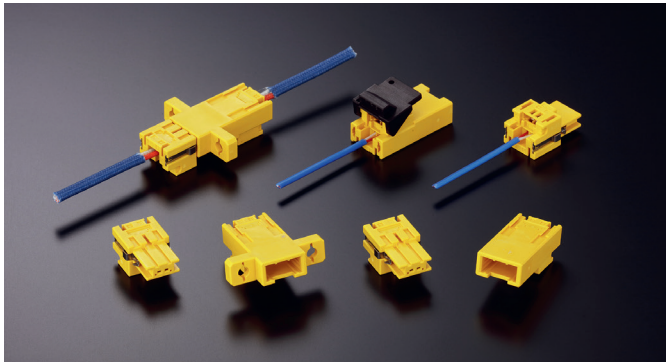

TE Connectivity's new K-type Thermocouple connector enables easy connection with thermocouple wire. The unique spring terminal concept enables outstanding connectivity compared with the traditional screw type termination. The "push-on lock concept" allows easy mating while the unique shape of the metal-locking mechanism prevents unintentional unmating.

FEATURES

- 2 position for K type Thermocouple (+ : Chromel / - : Alumel)
- Touch Proof design supports IP20 degree of protection
- The unique shape metal-locking mechanism prevents unintentional unmating
- Supports Free-hanging and Panel Mount solution

BENEFITS

- Spring Clamp concept ensures outstanding connectivity/manufacturability
- The "Push-on lock concept" allows easy mating and secure locking which enables a highly reliable connections
- Space saving compact design
- Better Mating Reliability because of the metal lock concept which prevents unintentional un-mating and is supported by an audible click when mated
- Better assembly productivity; The spring clamp solution reduces the wire termination time considerably compared to current market standard screw termination solutions

APPLICATIONS

- Semiconductor Machinery
- Injection Molding Machine
- Machine Tool Equipment

MATERIAL

Contact: + : Chromel / - : Alumel

Housing: Thermoplastic

Strain Relief: Stainless steel

SPECIFICATION

Type of Thermocouple: K type

Position number: 2 pos

Operation temperature: -20 °C to 220 °C
(In case of higher than 150 °C environment, do not reuse the connector)

Wire termination: Spring Clamp

Wire size: AWG#32-#20

PART NUMBERS

Description	Part Number
Receptacle Connector	1-2299959-1
Tab Connector (Free Hanging)	1-2299960-1
Tab Connector (Panel Mount)	2-2299960-1
Opener for spring terminal	2295226-1
Strain Relief for cable	2295205-1
Grommet for cable	2295225-1

STANDARDS & SPECIFICATIONS

- 108-140100 / 501-78646

Thermocouple Connector

PRODUCT OVERVIEW

Receptacle Connector, Part-Number: 1-2299959-1

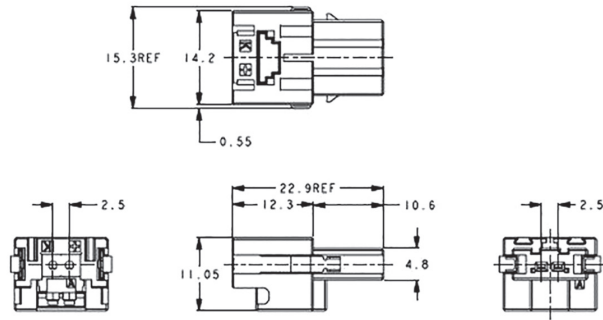
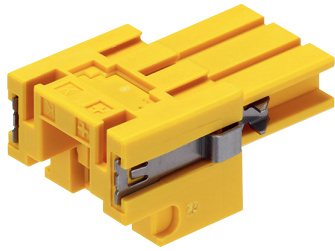

Tab Connector (Free Hanging), Part-Number: 1-2299960-1

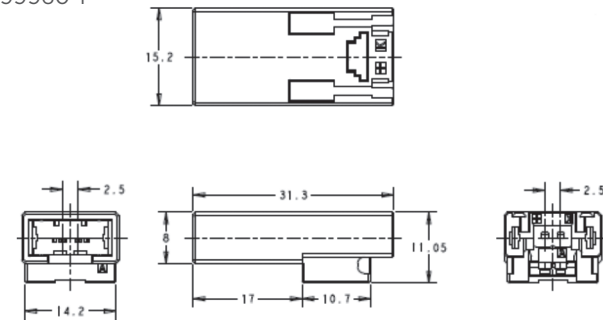
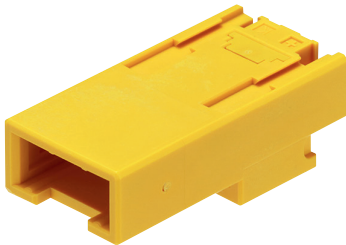

Tab Connector (Panel Mount), Part-Number: 2-2299960-1

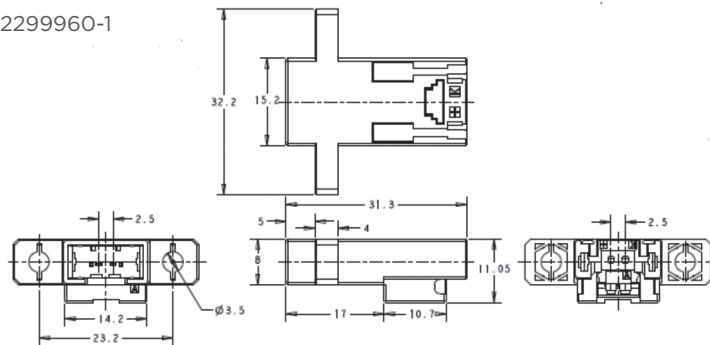
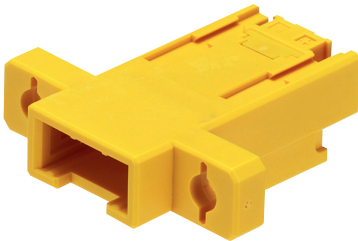

OPTIONAL PARTS

Description	Part Number
Opener for spring terminal	2295226-1
Strain Relief for cable	2295205-1
Grommet for cable	2295225-1



Opener



Strain Relief



Grommet

te.com

TE Connectivity, TE Connectivity (logo) and Every Connection Counts are trademarks. All other logos, products and/or company names referred to herein might be trademarks of their respective owners.

The information given herein, including drawings, illustrations and schematics which are intended for illustration purposes only, is believed to be reliable. However, TE Connectivity makes no warranties as to its accuracy or completeness and disclaims any liability in connection with its use. TE Connectivity's obligations shall only be as set forth in TE Connectivity's Standard Terms and Conditions of Sale for this product and in no case will TE Connectivity be liable for any incidental, indirect or consequential damages arising out of the sale, resale, use or misuse of the product. Users of TE Connectivity products should make their own evaluation to determine the suitability of each such product for the specific application.

© 2016 TE Connectivity Ltd. family of companies All Rights Reserved.

1-1773895-2 09/2016 Original: WR

PRODUCT SHEET

TE Connectivity
Automation & Control

Pfnorstr. 1
D-64293 Darmstadt
Germany

+49 6151 607 1999

www.te.com

LEGAL ENTITY