



## Features

- Radial Leaded Devices
- Cured, flame retardant epoxy polymer insulating material meets UL 94V-0 requirements
- RoHS compliant\* and halogen free\*\*
- Agency recognition: 

## Applications

- Almost anywhere there is a low voltage power supply and a load to be protected, including:
- Computers & peripherals
  - General electronics
  - Automotive applications

# MF-R Series - PTC Resettable Fuses

### Electrical Characteristics

Model	V max. Volts	I max. Amps	Ihold	Itrip	Initial Resistance		1 Hour (R <sub>1</sub> ) Post-Trip Resistance	Max. Time to Trip		Tripped Power Dissipation
			Amperes at 23 °C		Ohms at 23 °C		Ohms at 23 °C	Amperes at 23 °C	Seconds at 23 °C	Watts at 23 °C
			Hold	Trip	Min.	Max.	Max.			Typ.
MF-R005	60	40	0.05	0.10	7.3	11.1	22.0	0.5	5.0	0.22
MF-R010	60	40	0.10	0.20	2.50	4.50	7.50	0.5	4.0	0.38
MF-R017	60	40	0.17	0.34	2.00	3.20	8.00	0.85	3.0	0.48
MF-R020	60	40	0.20	0.40	1.50	2.84	4.40	1.0	2.2	0.40
MF-R025	60	40	0.25	0.50	1.00	1.95	3.00	1.25	2.5	0.45
MF-R030	60	40	0.30	0.60	0.76	1.36	2.10	1.5	3.0	0.50
MF-R040	60	40	0.40	0.80	0.52	0.86	1.29	2.0	3.8	0.55
MF-R050	60	40	0.50	1.00	0.41	0.77	1.17	2.5	4.0	0.75
MF-R065	60	40	0.65	1.30	0.27	0.48	0.72	3.25	5.3	0.90
MF-R075	60	40	0.75	1.50	0.18	0.40	0.60	3.75	6.3	0.90
MF-R090	60	40	0.90	1.80	0.14	0.31	0.47	4.5	7.2	1.00
MF-R090-0-9	30	40	0.90	1.80	0.07	0.12	0.22	4.5	5.9	0.60
MF-R110	30	40	1.10	2.20	0.10	0.18	0.27	5.5	6.6	0.70
MF-R135	30	40	1.35	2.70	0.065	0.115	0.17	6.75	7.3	0.80
MF-R160	30	40	1.60	3.20	0.055	0.105	0.15	8.0	8.0	0.90
MF-R185	30	40	1.85	3.70	0.040	0.07	0.11	9.25	8.7	1.00
MF-R250	30	40	2.50	5.00	0.025	0.048	0.07	12.5	10.3	1.20
MF-R250-0-10	30	40	2.50	5.00	0.025	0.048	0.07	12.5	10.3	1.20
MF-R300	30	40	3.00	6.00	0.020	0.05	0.08	15.0	10.8	2.00
MF-R400	30	40	4.00	8.00	0.010	0.03	0.05	20.0	12.7	2.50
MF-R500	30	40	5.00	10.00	0.010	0.03	0.05	25.0	14.5	3.00
MF-R600	30	40	6.00	12.00	0.005	0.02	0.04	30.0	16.0	3.50
MF-R700	30	40	7.00	14.00	0.005	0.02	0.03	35.0	17.5	3.80
MF-R800	30	40	8.00	16.00	0.005	0.02	0.03	40.0	18.8	4.00
MF-R900	30	40	9.00	18.00	0.005	0.01	0.02	40.0	20.0	4.20
MF-R1100	16	100	11.00	22.00	0.003	0.01	0.014	40.0	20.0	4.50

### Environmental Characteristics

Operating/Storage Temperature	-40 °C to +85 °C
Maximum Device Surface Temperature in Tripped State	125 °C
Passive Aging	+85 °C, 1000 hours.....±5 % typical resistance change
Humidity Aging	+85 °C, 85 % R.H. 1000 hours .....±5 % typical resistance change
Thermal Shock	-40 °C to +85 °C, 10 times .....±10 % typical resistance change
Solvent Resistance	MIL-STD-202, Method 215 .....No change
Vibration	MIL-STD-883C, Method 2007.1, .....No change Condition A

### Test Procedures And Requirements For Model MF-R Series

Test	Test Conditions	Accept/Reject Criteria
Visual/Mech.	Verify dimensions and materials	Per MF physical description
Resistance	In still air @ 23 °C	$R_{min} \leq R \leq R_{max}$
Time to Trip	5 times Ihold, Vmax, 23 °C	$T \leq \text{max. time to trip (seconds)}$
Hold Current	30 min. at Ihold	No trip
Trip Cycle Life	Vmax, Imax, 100 cycles	No arcing or burning
Trip Endurance	Vmax, 48 hours	No arcing or burning

UL File Number ..... E174545  
TÜV File Number ..... R2057213

\* RoHS Directive 2002/95/EC Jan. 27, 2003 including annex and RoHS Recast 2011/65/EU June 8, 2011.

\*\* Bourns follows the prevailing definition of "halogen free" in the industry. Bourns considers a product to be "halogen free" if (a) the Bromine (Br) content is 900 ppm or less; (b) the Chlorine (Cl) content is 900 ppm or less; and (c) the total Bromine (Br) and Chlorine (Cl) content is 1500 ppm or less.

Specifications are subject to change without notice.

The device characteristics and parameters in this data sheet can and do vary in different applications and actual device performance may vary over time. Users should verify actual device performance in their specific applications.

## Additional Features

- Bulk packaging, tape and reel and Ammo-Pak available on most models

# MF-R Series - PTC Resettable Fuses

# BOURNS®

Product Dimensions (see next page for outline drawing)

Model	A Max.	B Max.	C		D Min.	E Max.	Physical Characteristics		
			Nom.	Tol. ±			Style	Lead Dia.	Material
MF-R005	$\frac{8.0}{(0.315)}$	$\frac{8.3}{(0.327)}$	$\frac{5.1}{(0.201)}$	$\frac{0.7}{(0.028)}$	$\frac{7.6}{(0.299)}$	$\frac{3.1}{(0.122)}$	4	$\frac{0.405}{(0.016)}$	Sn/NiCu
MF-R010	$\frac{7.4}{(0.291)}$	$\frac{12.7}{(0.5)}$	$\frac{5.1}{(0.201)}$	$\frac{0.7}{(0.028)}$	$\frac{7.6}{(0.299)}$	$\frac{3.1}{(0.122)}$	1	$\frac{0.51}{(0.020)}$	Sn/NiCu
MF-R017	$\frac{7.4}{(0.291)}$	$\frac{12.7}{(0.5)}$	$\frac{5.1}{(0.201)}$	$\frac{0.7}{(0.028)}$	$\frac{7.6}{(0.299)}$	$\frac{3.1}{(0.122)}$	1	$\frac{0.51}{(0.020)}$	Sn/CuFe
MF-R020	$\frac{7.4}{(0.291)}$	$\frac{12.7}{(0.5)}$	$\frac{5.1}{(0.201)}$	$\frac{0.7}{(0.028)}$	$\frac{7.6}{(0.299)}$	$\frac{3.1}{(0.122)}$	1	$\frac{0.51}{(0.020)}$	Sn/CuFe
MF-R025	$\frac{7.4}{(0.291)}$	$\frac{12.7}{(0.5)}$	$\frac{5.1}{(0.201)}$	$\frac{0.7}{(0.028)}$	$\frac{7.6}{(0.299)}$	$\frac{3.1}{(0.122)}$	1	$\frac{0.51}{(0.020)}$	Sn/CuFe
MF-R030	$\frac{7.4}{(0.291)}$	$\frac{13.4}{(0.528)}$	$\frac{5.1}{(0.201)}$	$\frac{0.7}{(0.028)}$	$\frac{7.6}{(0.299)}$	$\frac{3.1}{(0.122)}$	1	$\frac{0.51}{(0.020)}$	Sn/CuFe
MF-R040	$\frac{7.4}{(0.291)}$	$\frac{13.7}{(0.539)}$	$\frac{5.1}{(0.201)}$	$\frac{0.7}{(0.028)}$	$\frac{7.6}{(0.299)}$	$\frac{3.1}{(0.122)}$	1	$\frac{0.51}{(0.020)}$	Sn/CuFe
MF-R050	$\frac{7.9}{(0.311)}$	$\frac{13.7}{(0.539)}$	$\frac{5.1}{(0.201)}$	$\frac{0.7}{(0.028)}$	$\frac{7.6}{(0.299)}$	$\frac{3.1}{(0.122)}$	1	$\frac{0.51}{(0.020)}$	Sn/Cu
MF-R065	$\frac{9.7}{(0.382)}$	$\frac{15.2}{(0.598)}$	$\frac{5.1}{(0.201)}$	$\frac{0.7}{(0.028)}$	$\frac{7.6}{(0.299)}$	$\frac{3.1}{(0.122)}$	1	$\frac{0.51}{(0.020)}$	Sn/Cu
MF-R075	$\frac{10.4}{(0.409)}$	$\frac{16.0}{(0.630)}$	$\frac{5.1}{(0.201)}$	$\frac{0.7}{(0.028)}$	$\frac{7.6}{(0.299)}$	$\frac{3.1}{(0.122)}$	1	$\frac{0.51}{(0.020)}$	Sn/Cu
MF-R090	$\frac{11.7}{(0.461)}$	$\frac{16.7}{(0.657)}$	$\frac{5.1}{(0.201)}$	$\frac{0.7}{(0.028)}$	$\frac{7.6}{(0.299)}$	$\frac{3.1}{(0.122)}$	1	$\frac{0.51}{(0.020)}$	Sn/Cu
MF-R090-0-9	$\frac{7.4}{(0.291)}$	$\frac{12.2}{(0.480)}$	$\frac{5.1}{(0.201)}$	$\frac{0.7}{(0.028)}$	$\frac{7.6}{(0.299)}$	$\frac{3.0}{(0.118)}$	3	$\frac{0.51}{(0.020)}$	Sn/CuFe
MF-R110	$\frac{8.9}{(0.350)}$	$\frac{14.0}{(0.551)}$	$\frac{5.1}{(0.201)}$	$\frac{0.7}{(0.028)}$	$\frac{7.6}{(0.299)}$	$\frac{3.0}{(0.118)}$	1	$\frac{0.51}{(0.020)}$	Sn/Cu
MF-R135	$\frac{8.9}{(0.350)}$	$\frac{18.9}{(0.744)}$	$\frac{5.1}{(0.201)}$	$\frac{0.7}{(0.028)}$	$\frac{7.6}{(0.299)}$	$\frac{3.0}{(0.118)}$	1	$\frac{0.51}{(0.020)}$	Sn/Cu
MF-R160	$\frac{10.2}{(0.402)}$	$\frac{16.8}{(0.661)}$	$\frac{5.1}{(0.201)}$	$\frac{0.7}{(0.028)}$	$\frac{7.6}{(0.299)}$	$\frac{3.0}{(0.118)}$	1	$\frac{0.51}{(0.020)}$	Sn/Cu
MF-R185	$\frac{12.0}{(0.472)}$	$\frac{18.4}{(0.724)}$	$\frac{5.1}{(0.201)}$	$\frac{0.7}{(0.028)}$	$\frac{7.6}{(0.299)}$	$\frac{3.0}{(0.118)}$	1	$\frac{0.51}{(0.020)}$	Sn/Cu
MF-R250	$\frac{12.0}{(0.472)}$	$\frac{18.3}{(0.720)}$	$\frac{5.1}{(0.201)}$	$\frac{0.7}{(0.028)}$	$\frac{7.6}{(0.299)}$	$\frac{3.0}{(0.118)}$	2	$\frac{0.81}{(0.032)}$	Sn/Cu
MF-R250-0-10	$\frac{12.0}{(0.472)}$	$\frac{18.3}{(0.720)}$	$\frac{5.1}{(0.201)}$	$\frac{0.7}{(0.028)}$	$\frac{7.6}{(0.299)}$	$\frac{3.0}{(0.118)}$	3	$\frac{0.51}{(0.020)}$	Sn/CuFe
MF-R300	$\frac{12.0}{(0.472)}$	$\frac{18.3}{(0.720)}$	$\frac{5.1}{(0.201)}$	$\frac{0.7}{(0.028)}$	$\frac{7.6}{(0.299)}$	$\frac{3.0}{(0.118)}$	2	$\frac{0.81}{(0.032)}$	Sn/Cu
MF-R400	$\frac{14.4}{(0.567)}$	$\frac{24.8}{(0.976)}$	$\frac{5.1}{(0.201)}$	$\frac{0.7}{(0.028)}$	$\frac{7.6}{(0.299)}$	$\frac{3.0}{(0.118)}$	2	$\frac{0.81}{(0.032)}$	Sn/Cu
MF-R500	$\frac{17.4}{(0.685)}$	$\frac{24.9}{(0.980)}$	$\frac{10.2}{(0.402)}$	$\frac{0.7}{(0.028)}$	$\frac{7.6}{(0.299)}$	$\frac{3.0}{(0.118)}$	2	$\frac{0.81}{(0.032)}$	Sn/Cu
MF-R600	$\frac{19.3}{(0.760)}$	$\frac{31.9}{(1.256)}$	$\frac{10.2}{(0.402)}$	$\frac{0.7}{(0.028)}$	$\frac{7.6}{(0.299)}$	$\frac{3.0}{(0.118)}$	2	$\frac{0.81}{(0.032)}$	Sn/Cu
MF-R700	$\frac{22.1}{(0.870)}$	$\frac{29.8}{(1.173)}$	$\frac{10.2}{(0.402)}$	$\frac{0.7}{(0.028)}$	$\frac{7.6}{(0.299)}$	$\frac{3.0}{(0.118)}$	2	$\frac{0.81}{(0.032)}$	Sn/Cu
MF-R800	$\frac{24.2}{(0.953)}$	$\frac{32.9}{(1.295)}$	$\frac{10.2}{(0.402)}$	$\frac{0.7}{(0.028)}$	$\frac{7.6}{(0.299)}$	$\frac{3.0}{(0.118)}$	2	$\frac{0.81}{(0.032)}$	Sn/Cu
MF-R900	$\frac{24.2}{(0.953)}$	$\frac{32.9}{(1.295)}$	$\frac{10.2}{(0.402)}$	$\frac{0.7}{(0.028)}$	$\frac{7.6}{(0.299)}$	$\frac{3.0}{(0.118)}$	2	$\frac{0.81}{(0.032)}$	Sn/Cu
MF-R1100	$\frac{24.2}{(0.953)}$	$\frac{32.9}{(1.295)}$	$\frac{10.2}{(0.402)}$	$\frac{0.7}{(0.028)}$	$\frac{7.6}{(0.299)}$	$\frac{3.0}{(0.118)}$	2	$\frac{0.81}{(0.032)}$	Sn/Cu

Packaging options:

BULK: All models = 500 pcs. per bag

TAPE & REEL: MF-R005-MF-R160 12.7 mm device pitch = 3000 pcs. per reel  
 MF-R185-MF-R400 25.4 mm device pitch = 1500 pcs. per reel  
 MF-R500-MF-R1100 25.4 mm device pitch = 1000 pcs. per reel

AMMO-PACK: MF-R005-MF-R160 12.7 mm device pitch = 2000 pcs. per pack  
 MF-R185-MF-R400 25.4 mm device pitch = 1000 pcs. per pack  
 MF-R500-MF-R1100 25.4 mm device pitch = 500 pcs. per pack

0.405 (26AWG)  
 0.51 (24AWG)  
 0.81 (20AWG)

DIMENSIONS:  $\frac{\text{MM}}{\text{(INCHES)}}$

Specifications are subject to change without notice.

The device characteristics and parameters in this data sheet can and do vary in different applications and actual device performance may vary over time. Users should verify actual device performance in their specific applications.

# MF-R Series - PTC Resettable Fuses

**BOURNS®**

## Product Dimensions (see previous page for dimensions)

Style 1

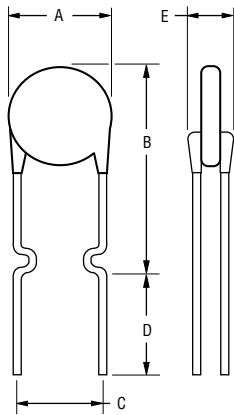

Style 2

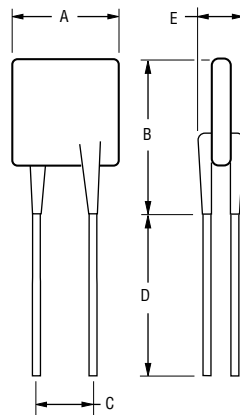

Style 3

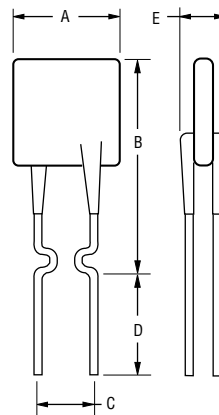

Style 4

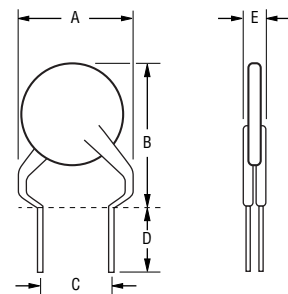

NOTE: Kinked lead option is available for board standoff. Contact factory for details.

NOTE: Also available with straight leads. Contact factory for details.

## Thermal Derating Chart - I<sub>hold</sub> / I<sub>trip</sub> (Amps)

Model	Ambient Operating Temperature								
	-40 °C	-20 °C	0 °C	23 °C	40 °C	50 °C	60 °C	70 °C	85 °C
MF-R005	0.08 / 0.16	0.07 / 0.14	0.06 / 0.12	0.05 / 0.10	0.04 / 0.08	0.04 / 0.08	0.03 / 0.07	0.03 / 0.07	0.02 / 0.05
MF-R010	0.16 / 0.32	0.14 / 0.28	0.12 / 0.24	0.10 / 0.20	0.08 / 0.16	0.07 / 0.14	0.06 / 0.12	0.05 / 0.10	0.04 / 0.08
MF-R017	0.26 / 0.52	0.23 / 0.46	0.20 / 0.40	0.17 / 0.34	0.14 / 0.28	0.12 / 0.24	0.11 / 0.22	0.09 / 0.18	0.07 / 0.14
MF-R020	0.31 / 0.62	0.27 / 0.54	0.24 / 0.48	0.20 / 0.40	0.16 / 0.32	0.14 / 0.28	0.13 / 0.26	0.11 / 0.22	0.08 / 0.16
MF-R025	0.39 / 0.78	0.34 / 0.68	0.30 / 0.60	0.25 / 0.50	0.20 / 0.40	0.18 / 0.36	0.16 / 0.32	0.14 / 0.28	0.10 / 0.20
MF-R030	0.47 / 0.94	0.41 / 0.82	0.36 / 0.72	0.30 / 0.60	0.24 / 0.48	0.22 / 0.44	0.19 / 0.38	0.16 / 0.32	0.12 / 0.24
MF-R040	0.62 / 1.24	0.54 / 1.08	0.48 / 0.96	0.40 / 0.80	0.32 / 0.64	0.29 / 0.58	0.25 / 0.50	0.22 / 0.44	0.16 / 0.32
MF-R050	0.78 / 1.56	0.68 / 1.36	0.60 / 1.20	0.50 / 1.00	0.41 / 0.82	0.36 / 0.72	0.32 / 0.64	0.27 / 0.54	0.20 / 0.40
MF-R065	1.01 / 2.02	0.88 / 1.76	0.77 / 1.54	0.65 / 1.30	0.53 / 1.06	0.47 / 0.94	0.41 / 0.82	0.35 / 0.70	0.26 / 0.52
MF-R075	1.16 / 2.32	1.02 / 2.04	0.89 / 1.78	0.75 / 1.50	0.61 / 1.22	0.54 / 1.08	0.47 / 0.94	0.41 / 0.82	0.30 / 0.60
MF-R090	1.40 / 2.80	1.22 / 2.44	1.07 / 2.14	0.90 / 1.80	0.73 / 1.46	0.65 / 1.30	0.57 / 1.14	0.49 / 0.98	0.36 / 0.72
MF-R090-0-9	1.40 / 2.80	1.22 / 2.44	1.07 / 2.14	0.90 / 1.80	0.73 / 1.46	0.65 / 1.30	0.57 / 1.14	0.49 / 0.98	0.36 / 0.72
MF-R110	1.60 / 3.20	1.43 / 2.86	1.27 / 2.54	1.10 / 2.20	0.91 / 1.82	0.85 / 1.70	0.75 / 1.50	0.67 / 1.34	0.57 / 1.14
MF-R135	1.96 / 3.92	1.76 / 3.52	1.55 / 3.10	1.35 / 2.70	1.12 / 2.24	1.04 / 2.08	0.92 / 1.84	0.82 / 1.64	0.70 / 1.40
MF-R160	2.32 / 4.64	2.08 / 4.16	1.84 / 3.68	1.60 / 3.20	1.33 / 2.66	1.23 / 2.46	1.09 / 2.18	0.98 / 1.96	0.83 / 1.66
MF-R185	2.68 / 5.36	2.41 / 4.82	2.13 / 4.26	1.85 / 3.70	1.54 / 3.08	1.42 / 2.84	1.26 / 2.52	1.13 / 2.26	0.96 / 1.92
MF-R250	3.63 / 7.26	3.25 / 6.50	2.88 / 5.76	2.50 / 5.00	2.08 / 4.16	1.93 / 3.86	1.70 / 3.40	1.53 / 3.06	1.30 / 2.60
MF-R250-0-10	3.63 / 7.26	3.25 / 6.50	2.88 / 5.76	2.50 / 5.00	2.08 / 4.16	1.93 / 3.86	1.70 / 3.40	1.53 / 3.06	1.30 / 2.60
MF-R300	4.35 / 8.70	3.90 / 7.80	3.45 / 6.90	3.00 / 6.00	2.49 / 4.98	2.31 / 4.62	2.04 / 4.08	1.83 / 3.66	1.56 / 3.12
MF-R400	5.80 / 11.6	5.20 / 10.4	4.60 / 9.20	4.00 / 8.00	3.32 / 6.64	3.08 / 6.16	2.72 / 5.44	2.44 / 4.88	2.08 / 4.16
MF-R500	7.25 / 14.5	6.50 / 13.0	5.75 / 11.5	5.00 / 10.0	4.15 / 8.30	3.85 / 7.70	3.40 / 6.80	3.05 / 6.10	2.60 / 5.20
MF-R600	8.70 / 17.4	7.80 / 15.6	6.90 / 13.8	6.00 / 12.0	4.98 / 9.96	4.62 / 9.24	4.08 / 8.16	3.66 / 7.32	3.12 / 6.24
MF-R700	10.1 / 20.3	9.10 / 18.2	8.05 / 16.1	7.00 / 14.0	5.81 / 11.6	5.39 / 10.7	4.76 / 9.52	4.27 / 9.44	3.64 / 7.28
MF-R800	11.6 / 23.2	10.4 / 20.8	9.20 / 18.4	8.00 / 16.0	6.64 / 13.2	6.16 / 12.3	5.44 / 10.8	4.88 / 9.76	4.16 / 8.32
MF-R900	13.0 / 26.1	11.7 / 23.4	10.3 / 20.7	9.00 / 18.0	7.47 / 14.9	6.93 / 12.7	6.12 / 12.2	5.49 / 10.9	4.68 / 9.36
MF-R1100	16.1 / 32.0	14.6 / 29.2	13.1 / 26.2	11.0 / 22.1	9.40 / 18.4	8.80 / 17.6	7.80 / 15.6	6.90 / 13.8	5.20 / 10.4

Specifications are subject to change without notice. The device characteristics and parameters in this data sheet can and do vary in different applications and actual device performance may vary over time. Users should verify actual device performance in their specific applications.

# MF-R Series - PTC Resettable Fuses

**BOURNS®**

## Typical Time to Trip at 23 °C

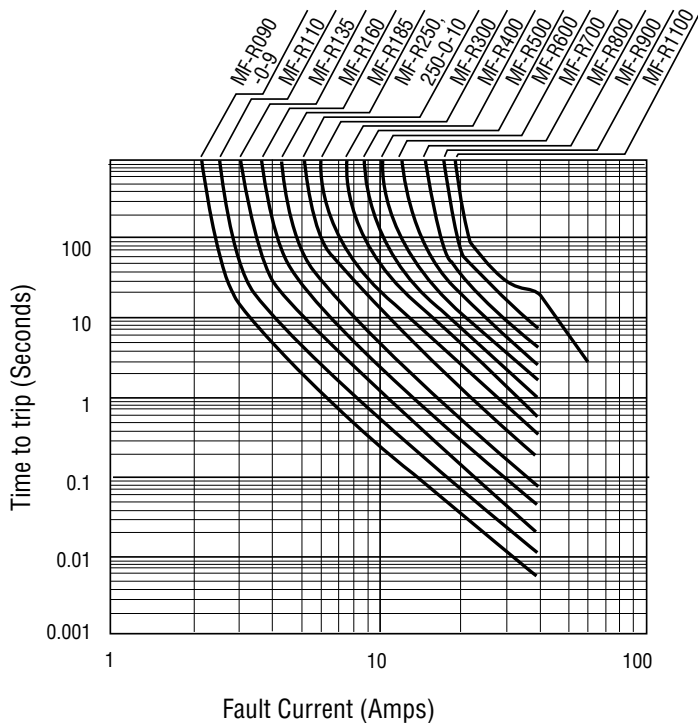
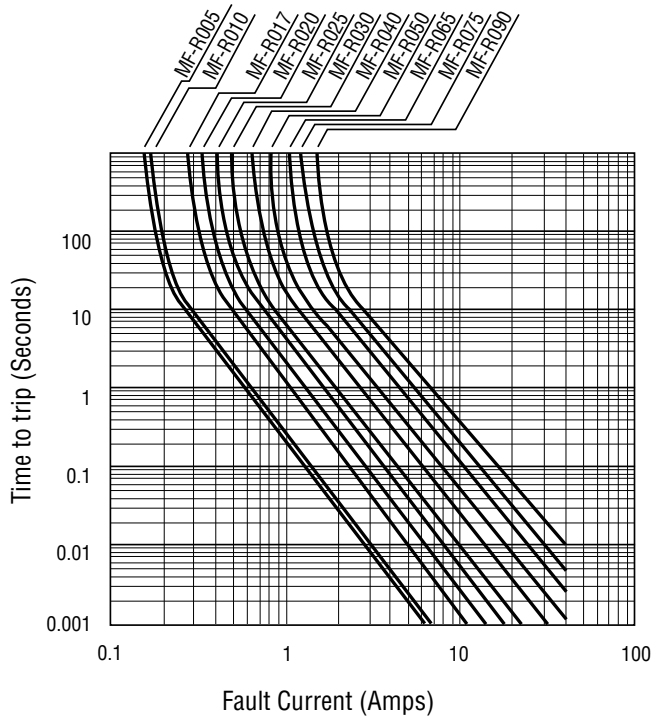

## How to Order

**MF - R 110 - 0 - 99**

Multifuse®  
Product Designator

Series  
R = Radial Leaded Component

Hold Current, I<sub>hold</sub>  
005-1100 (0.05 Amps - 11.0 Amps)

Packaging Options

- = Bulk Packaging without part number suffix option
- 0-99 = Bulk Packaging with part number suffix option
- 2 = Tape and Reel without part number suffix option\*
- 2-99 = Tape and Reel with part number suffix option
- AP = Ammo-Pak\*
- 0-14 = Kinked leads where straight leads are standard
- 0-17 = Straight leads where kinked leads are standard

Part Number Suffix Option

- 99 = As of date code April 1, 2005 all MF-R models are RoHS compliant. The suffix "-99" can be used if a new part number is required to reference the RoHS compliance.

Examples:

- MF-R110..... Bulk packaging
- MF-R110-0-99..... Bulk packaging with part number suffix option
- MF-R110-2..... Tape and reel packaging
- MF-R110-2-99..... Tape and reel packaging with part number suffix option
- MF-R090-0-9-99..... Bulk packaging with part number suffix option
- MF-R250-0-10-99..... Bulk packaging with part number suffix option

\*Packaged per EIA486-B

### Typical Part Marking: MF-R005 - R025

Represents total content. Layout may vary.

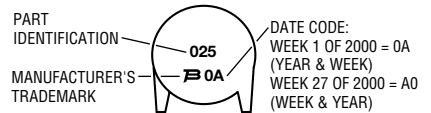

### Typical Part Marking: MF-R030 - R1100

Represents total content. Layout may vary.

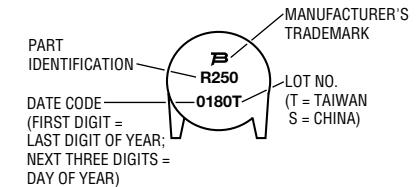

MF-R SERIES, REV. AF, 07/17

The device characteristics and parameters in this data sheet can and do vary in different applications and actual device performance may vary over time. Users should verify actual device performance in their specific applications.

## MF-R, MF-R/90, MF-R/600, & MF-RX, & MF-RX/72 Series Tape and Reel Specifications

**BOURNS®**

Devices taped using EIA468-B/IEC286-2 standards. See table below and Figures 1 and 2 for details.

Dimension Description	IEC Mark	EIA Mark	Dimensions	
			Dimensions	Tolerance
Carrier tape width	$W$	$W$	$\frac{18}{(.709)}$	$\frac{-0.5/+1.0}{(-0.02/+0.039)}$
Hold down tape width	$W_0$	$W_4$	$\frac{11}{(.433)}$	min.
Hold down tape			No protrusion	
Top distance between tape edges	$W_2$	$W_6$	$\frac{3}{(.118)}$	max.
Sprocket hole position	$W_1$	$W_5$	$\frac{9}{(.354)}$	$\frac{-0.5/+0.75}{(-0.02/+0.03)}$
Sprocket hole diameter	$D_0$	$D_0$	$\frac{4}{(.157)}$	$\frac{\pm 0.2}{(\pm .0078)}$
Abscissa to plane (straight lead)	$H$	$H$	$\frac{18.5}{(.728)}$	$\frac{\pm 3.0}{(\pm .118)}$
Abscissa to plane (kinked lead)	$H_0$	$H_0$	$\frac{16}{(.63)}$	$\frac{\pm 0.5}{(\pm .02)}$
Abscissa to top (straight lead)	$H_1$	$H_1$	$\frac{38.0}{(1.496)}$	max.
Abscissa to top (kinked lead)	$H_1$	$H_1$	$\frac{32.2}{(1.268)}$	max.
Overall width w/lead protrusion (straight lead)		$C_1$	$\frac{55.0}{(2.165)}$	max.
Overall width w/lead protrusion (kinked lead)		$C_1$	$\frac{43.2}{(1.7)}$	max.
Overall width w/o lead protrusion (straight lead)		$C_2$	$\frac{54.0}{(2.126)}$	max.
Overall width w/o lead protrusion (kinked lead)		$C_2$	$\frac{42.5}{(1.673)}$	max.
Lead protrusion	$l_1$	$L_1$	$\frac{1.0}{(.039)}$	max.
Protrusion of cutout	$L$	$L$	$\frac{11}{(.433)}$	max.
Protrusion beyond hold-down tape	$l_2$	$l_2$	Not specified	
Sprocket hole pitch	$P_0$	$P_0$	$\frac{12.7}{(0.5)}$	$\frac{\pm 0.3}{(\pm .012)}$
Pitch tolerance			20 consecutive	$\frac{\pm 1}{(\pm .039)}$
Device pitch: MF-R005–MF-R160, MF-R/90, MF-RX020/72–MF-RX030/72			$\frac{12.7}{(0.5)}$	$\frac{\pm 0.3}{(\pm .012)}$
Device pitch: MF-R185–MF-R400, MF-R/600, MF-RX110–MF-RX375 MF-RX040/72–MF-RX375/72			$\frac{25.4}{(1.0)}$	$\frac{\pm 0.6}{(\pm .024)}$
Tape thickness	$t$	$t$	$\frac{0.9}{(.035)}$	max.
Tape thickness with splice: MF-R010–MF-R160, MF-RX110/72–MF-RX185/72		$t_1$	$\frac{1.5}{(.059)}$	max.
Tape thickness with splice: MF-R250–MF-R1100, MF-RX110–MF-RX375, MF-R/90, MF-RX250/72–MF-RX375/72		$t_1$	$\frac{2.3}{(.091)}$	max.
Splice sprocket hole alignment			0	$\frac{\pm 0.3}{(\pm .012)}$
Body lateral deviation	$\Delta_h$	$\Delta_h$	0	$\frac{\pm 1.0}{(\pm .039)}$
Body tape plane deviation	$\Delta_p$	$\Delta_p$	0	$\frac{\pm 1.3}{(\pm .051)}$

DIMENSIONS:  $\frac{\text{MM}}{\text{(INCHES)}}$

Specifications are subject to change without notice.

The device characteristics and parameters in this data sheet can and do vary in different applications and actual device performance may vary over time. Users should verify actual device performance in their specific applications.

# MF-R, MF-R/90, MF-R/600, MF-RX, & MF-RX/72 Series Tape and Reel Specifications

**BOURNS®**

Dimension Description	IEC Mark	EIA Mark	Dimensions	
			Dimensions	Tolerance
Lead spacing: MF-R, MF-R/90, MF-R/600, MF-RX, MF-RX/72	<i>F</i>	<i>F</i>	$\frac{5.08}{(0.2)}$	$\frac{\pm 0.2}{(\pm 0.008)}$
Reel width	<i>w</i>	<i>W<sub>2</sub></i>	$\frac{56.0}{(2.205)}$	max.
Reel diameter	<i>d</i>	<i>a</i>	$\frac{370.0}{(14.57)}$	max.
Space between flanges less device	<i>W<sub>1</sub></i>	<i>h</i>	$\frac{4.75}{(.187)}$	$\frac{\pm 3.25}{(\pm .128)}$
Arbor hole diameter	<i>f</i>	<i>c</i>	$\frac{26.0}{(1.024)}$	$\frac{\pm 12.0}{(\pm .472)}$
Core diameter: MF-R, MF-RX, MF-R/90	<i>h</i>	<i>n</i>	$\frac{80}{(3.15)}$	max.
Core diameter: MF-R/600	<i>h</i>	<i>n</i>	$\frac{91}{(3.58)}$	max.
Box: MF-R, MF-RX, MF-R/90			$\frac{62}{(2.44)}$ $\frac{355}{(14.0)}$ $\frac{345}{(13.6)}$	nom.
Box: MF-R/600			$\frac{64}{(2.52)}$ $\frac{372}{(14.6)}$ $\frac{362}{(14.25)}$	max.
Consecutive missing places: MF-R, MF-RX, MF-R/90			3	max.
Consecutive missing places: MF-R/600			none	
Empty places per reel: MF-R, MF-RX, MF-R/90			Not specified	
Empty places per reel: MF-R/600			0.1 %	

**Taped Component Dimensions -  
Figure 1**

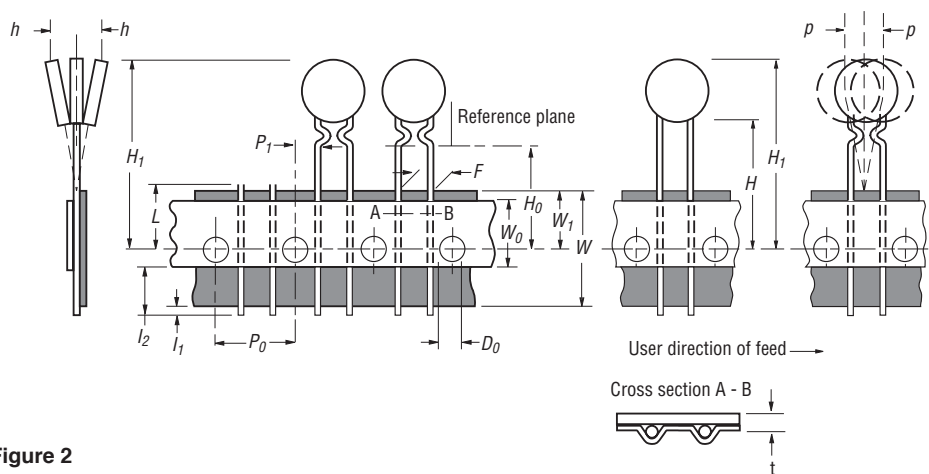

**Reel Dimensions - Figure 2**

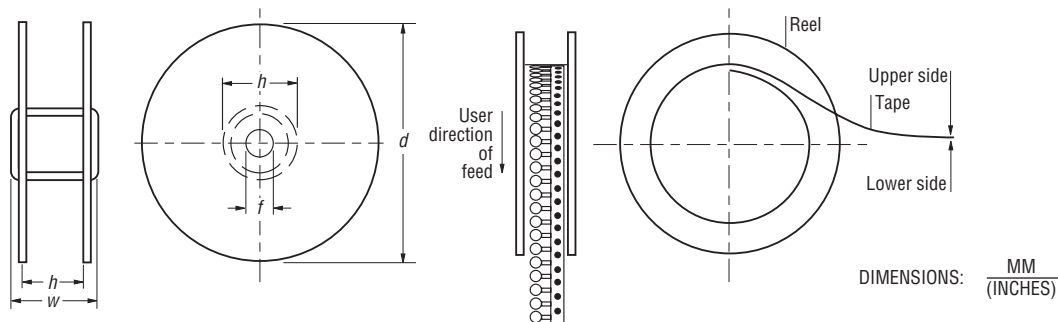

Specifications are subject to change without notice.  
The device characteristics and parameters in this data sheet can and do vary in different applications and actual device performance may vary over time.  
Users should verify actual device performance in their specific applications.