

# Surface Mount Zener Diode

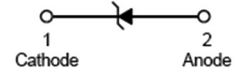
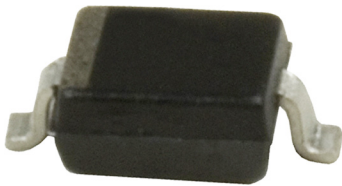

SOD-123

## Features:

- Planar Die Construction
- 500mW Power Dissipation On Ceramic PCB
- General Purpose, Medium Current
- Ideally Suited for Automated Assembly Processes

## Applications:

- Zener diode
- Ultra-small surface mount package

## Maximum Rating @ T<sub>A</sub> = 25°C unless otherwise specified

Characteristic	Symbol	Value	Unit
Forward voltage @ I <sub>F</sub> =10mA	V <sub>F</sub>	0.9	V
Power dissipation	P <sub>D</sub>	500	mW
Thermal resistance, junction to ambient air	R <sub>θJA</sub>	305	°C/W
Junction temperature	T <sub>j</sub>	150	°C
Storage temperature range	T <sub>stg</sub>	-65 to +150	°C

**Note** : Device mounted on ceramic PCB; 7.6mm × 9.4mm × 0.87mm with pad areas 25mm<sup>2</sup>

Short duration test pulse used to minimize self-heating effect.

When provided, otherwise, parts are provided with date code only, and type number identifications appears on reel only.

f = 1kHz

## Electrical Characteristics @ T<sub>A</sub> = 25°C unless otherwise specified

Type Number	Marking Code	Zener Voltage Range				Maximum Zener Impedance			Maximum Reverse Current		Typical Temperature Coefficient@ I <sub>ZTC</sub> mV/°C		Test Current I <sub>ZTC</sub> mA
		V <sub>Z</sub> @I <sub>ZT</sub>			I <sub>ZT</sub>	Z <sub>ZT</sub> @I <sub>ZT</sub>	Z <sub>ZK</sub> @I <sub>ZK</sub>	I <sub>ZK</sub>	I <sub>R</sub>	@V <sub>R</sub>	I <sub>ZTC</sub> mV/°C		
		Nom(V)	Min(V)	Max(V)	mA	Ω	mA	μA	V	Min	Max		
BZT52C30	WQ	30	28	32	2	80	300	0.5	0.1	21	24.4	29.4	2

# Surface Mount Zener Diode

Typical Characteristics @  $T_A = 25^\circ\text{C}$  unless otherwise specified

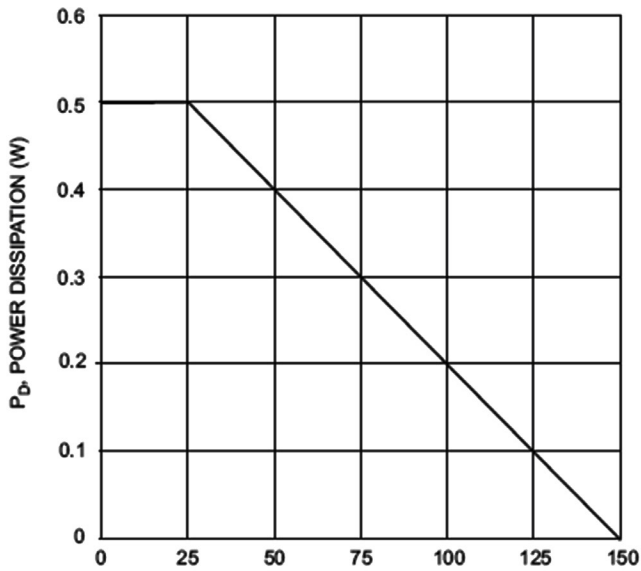

Fig. 1 Power Dissipation vs Ambient Temperature

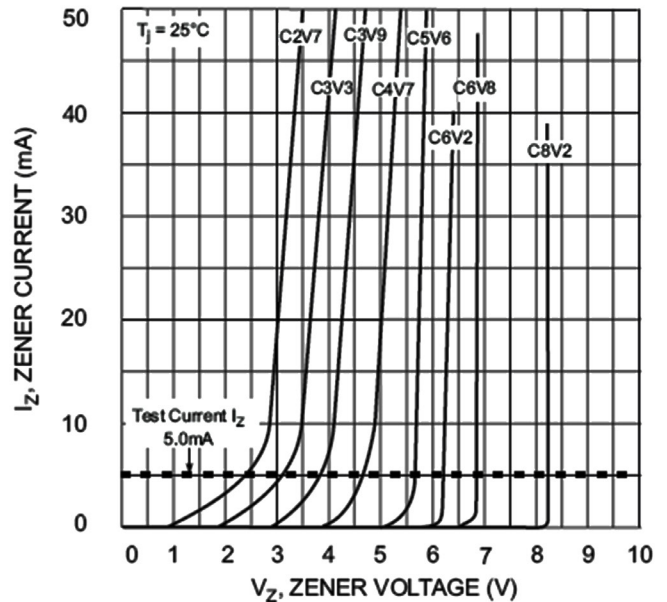

Fig. 2 Zener Breakdown Characteristics

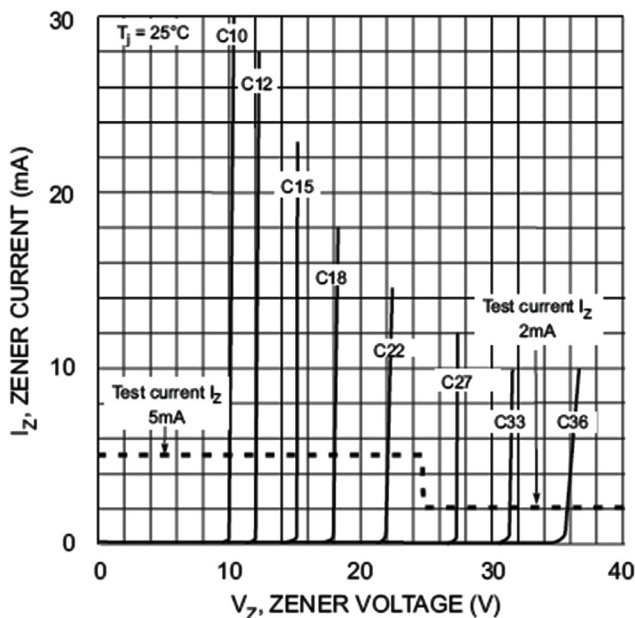

Fig. 3 Zener Breakdown Characteristics

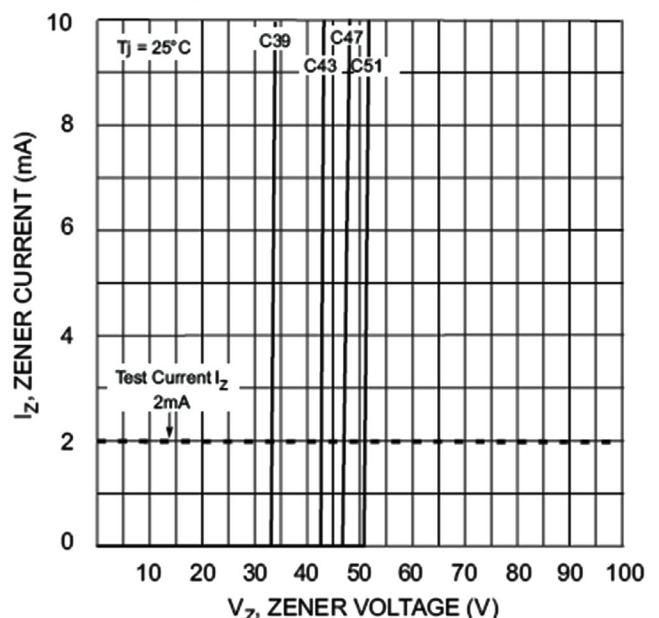

Fig. 4 Zener Breakdown Characteristics

# Surface Mount Zener Diode

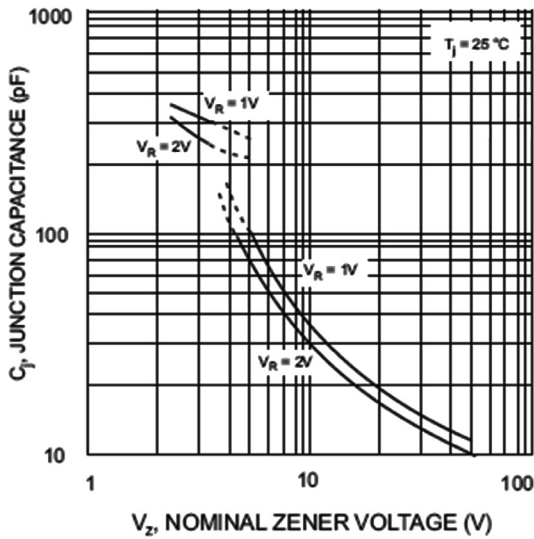
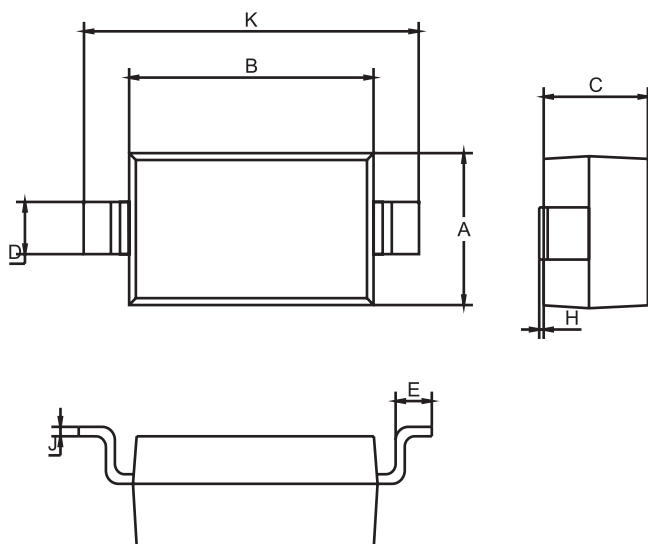

Fig. 5 Junction Capacitance vs Nominal Zener Voltage

## Package Outline

Plastic surface mounted package



SOD-123		
Dim	Min	Max
A	1.4	1.8
B	2.55	2.85
C	1.15 Typical	
D	0.5	0.6
E	0.3	0.4
H	0.02	0.10
J	0.1 Typical	
K	3.55	3.85
All Dimensions in mm		

# Surface Mount Zener Diode

**multicomp** PRO

## Soldering Footprint

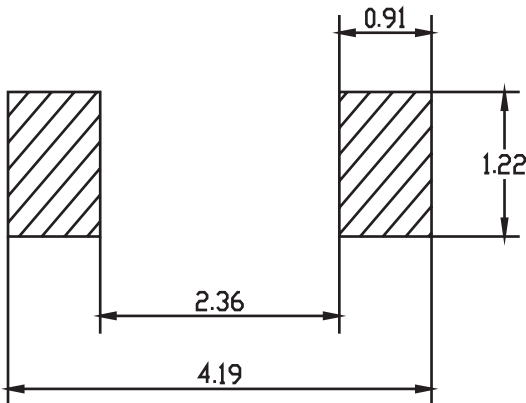

## Package Information

Device	Package	Shipping
BZT52C30-7-F	SOD-123	3,000/Tape & Reel

## Part Number Table

Description	Part Number
Surface Mount Zener Diode	BZT52C30-7-F

**Important Notice :** This data sheet and its contents (the "Information") belong to the members of the AVNET group of companies (the "Group") or are licensed to it. No licence is granted for the use of it other than for information purposes in connection with the products to which it relates. No licence of any intellectual property rights is granted. The Information is subject to change without notice and replaces all data sheets previously supplied. The Information supplied is believed to be accurate but the Group assumes no responsibility for its accuracy or completeness, any error in or omission from it or for any use made of it. Users of this data sheet should check for themselves the Information and the suitability of the products for their purpose and not make any assumptions based on information included or omitted. Liability for loss or damage resulting from any reliance on the Information or use of it (including liability resulting from negligence or where the Group was aware of the possibility of such loss or damage arising) is excluded. This will not operate to limit or restrict the Group's liability for death or personal injury resulting from its negligence. Multicomp Pro is the registered trademark of Premier Farnell Limited 2019.

Newark.com/multicomp-pro  
Farnell.com/multicomp-pro  
Element14.com/multicomp-pro

**multicomp** PRO