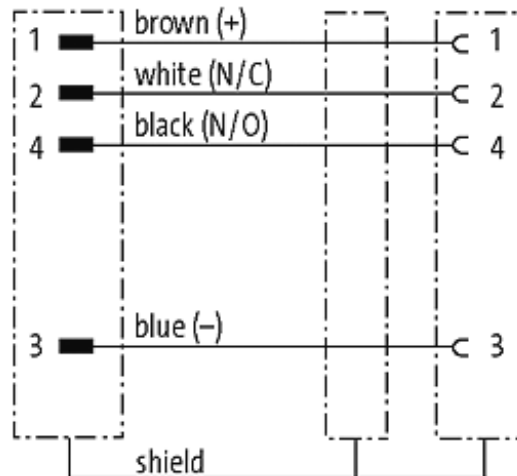

**M12 MALE 0° / M12 FEMALE 90° SHIELDED**

PUR 4X0.34 shielded black UL/CSA, drag ch 5m

Male straight to female 90°  
M12 - M12, 4-pole  
shielded

Plastic housings with good resistance against chemicals and oils. The resistance to aggressive media should be individually tested for your application. Further details on request. Further cable lengths on request.

**[Link to Product](#)****Illustration**

Male

Female

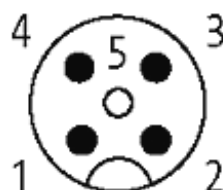

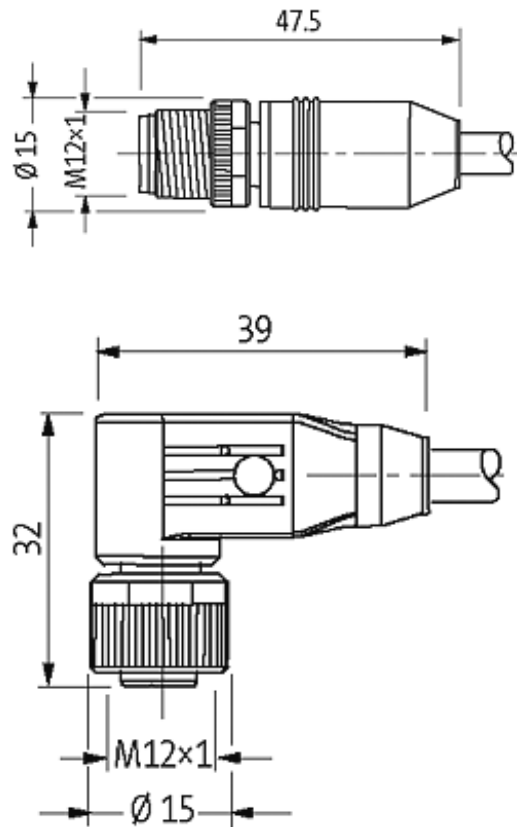

Product may differ from Image