

## Power line chokes

Current-compensated ring core double chokes  
250 V AC, 0.5 ... 6 A, 1 ... 82 mH

**Series/Type:** B82724A/J

**Date:** July 2012

**Rated voltage 250 V AC**
**Rated current 0.5 ... 6 A**
**Rated inductance 1 ... 82 mH**

### Construction

- Current-compensated ring core double choke
- Ferrite core with epoxy coating (UL 94 V-0)
- Polycarbonate case (UL 94 V-0)
- Polyurethane potting (UL 94 V-0)
- Sector winding

**B82724A**

### Features

- High resonance frequency due to special winding technique
- Approx. 1% stray inductance for symmetrical interference suppression
- Suitable for wave soldering
- Design complies with EN 60938-2 (VDE 0565-2) and UL 1283
- UL<sup>1)</sup> and/or ENEC (VDE) approvals 
- RoHS-compatible

**B82724J**

### Applications

- Suppression of common-mode interferences
- Switch-mode power applications
- Electronic ballasts in lamps
- Power inverters

### Terminals

- Base material CuNi18Zn20
- Layer composition Ni, Sn
- Hot-dipped
- Pins 0.7 × 0.7 (mm)
- Lead spacing 15 × 12.5 (mm) or 30 × 20 (mm)

### Marking

- Manufacturer, approval signs and/or VDE standard number, ordering code, graphic symbol, rated current, rated voltage, rated inductance, date of manufacture (YYWWDD.internal ID code)

### Delivery mode

- Blister tray in cardboard box

1) UL approval with 300 V AC

**Dimensional drawings and pin configuration**

Horizontal version (B82724A)

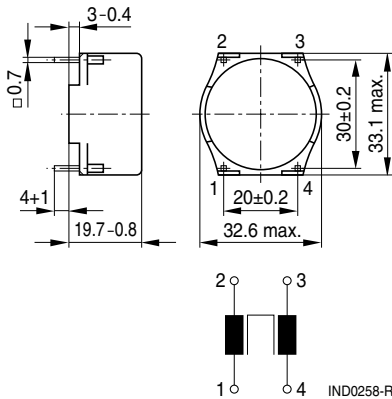

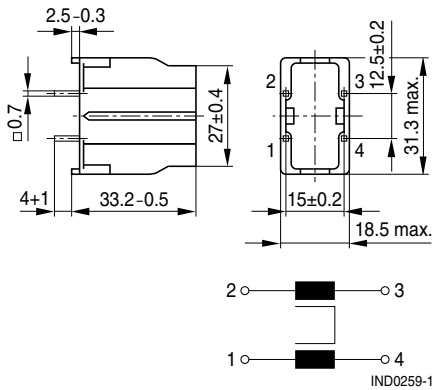

Vertical version (B82724J)

 Tolerances to ISO 2768-C unless otherwise noted.  
 Dimensions in mm.

**Technical data and measuring conditions**

|   |  |
|---|--|
| Rated voltage $V_R$                           | 250 V AC (50/60 Hz)  |
| Test voltage $V_{\text{test}}$                | 1500 V AC, 2 s (line/line)   |
| Rated temperature $T_R$                       | +40 °C / +45 °C / +50 °C / +60 °C / +70 °C   |
| Rated current $I_R$                           | Referred to 50 Hz and rated temperature  |
| Rated inductance $L_R$                        | Measured with Agilent 4284A at 0.1 mA, +20 °C<br>Measuring frequency: $L_R \leq 1 \text{ mH} = 100 \text{ kHz}$<br>$L_R > 1 \text{ mH} = 10 \text{ kHz}$<br>Inductance is specified per winding. |
| Inductance tolerance                          | $\pm 30\%$ at +20 °C   |
| Inductance decrease $\Delta L/L_0$            | < 10% at DC magnetic bias with $I_R$ , +20 °C  |
| Stray inductance $L_{\text{stray, typ}}$      | Measured with Agilent 4284A at 5 mA, +20 °C, typical values<br>Measuring frequency: $L_R \leq 1 \text{ mH} = 100 \text{ kHz}$<br>$L_R > 1 \text{ mH} = 10 \text{ kHz}$                           |
| DC resistance $R_{\text{typ}}$                | Measured at +20 °C, typical values, specified per winding  |
| Solderability (lead-free)                     | Sn96.5Ag3.0Cu0.5: +(245 $\pm$ 5) °C, (3 $\pm$ 0.3) s<br>Wetting of soldering area $\geq 95\%$<br>(to IEC 60068-2-20, test Ta)  |
| Resistance to soldering heat (wave soldering) | +(260 $\pm$ 5) °C, (10 $\pm$ 1) s<br>(to IEC 60068-2-20, test Tb)  |
| Climatic category                             | 40/125/56 (to IEC 60068-1)   |
| Storage conditions (packaged)                 | -25 °C ... +40 °C, $\leq 75\%$ RH  |
| Weight  | Approx. 27 g ... 32 g  |
| Approvals                                     | EN 60938-2, UL 1283  |

**Characteristics and ordering codes**

| I <sub>R</sub><br>A | L <sub>R</sub><br>mH | L <sub>stray,typ</sub><br>μH | R <sub>typ</sub><br>mΩ | T <sub>R</sub><br>°C | Ordering code      |                  | Approvals   |   |
|---------------------|----------------------|------------------------------|------------------------|----------------------|--------------------|------------------|---|---|
|                     |                      |                              |                        |                      | Horizontal version | Vertical version |  |  |
| 0.5                 | 82.0                 | 1000                         | 2300                   | +60                  | B82724A2501N001    | B82724J2501N001  | ×   | ×   |
| 0.5                 | 68.0                 | 700                          | 2000                   | +70                  | B82724A2501N020    | B82724J2501N020  | —   | —   |
| 0.8                 | 49.0                 | 500                          | 1950                   | +50                  | B82724A2801N002    | —                | ×   | —   |
| 0.8                 | 49.0                 | 500                          | 1950                   | +50                  | —                  | B82724J2801N002  | —   | —   |
| 1.0                 | 39.0                 | 350                          | 750                    | +60                  | B82724A2102N021    | B82724J2102N021  | ×   | ×   |
| 1.0                 | 33.0                 | 400                          | 750                    | +60                  | B82724A2102N001    | B82724J2102N001  | ×   | ×   |
| 1.4                 | 37.0                 | 320                          | 420                    | +60                  | B82724A2142N021    | B82724J2142N021  | ×   | ×   |
| 1.4                 | 27.0                 | 260                          | 460                    | +50                  | B82724A2142N001    | B82724J2142N001  | ×   | ×   |
| 1.6                 | 10.0                 | 120                          | 350                    | +60                  | B82724A2162N001    | B82724J2162N001  | ×   | ×   |
| 1.8                 | 33.0                 | 300                          | 400                    | +40                  | B82724A2182N021    | B82724J2182N021  | ×   | ×   |
| 2.0                 | 6.8                  | 80                           | 170                    | +60                  | B82724A2202N001    | B82724J2202N001  | ×   | ×   |
| 2.2                 | 20.0                 | 180                          | 250                    | +40                  | B82724A2222N021    | B82724J2222N021  | ×   | ×   |
| 2.2                 | 15.0                 | 140                          | 210                    | +45                  | B82724A2222N020    | B82724J2222N020  | ×   | ×   |
| 2.5                 | 10.0                 | 90                           | 140                    | +40                  | B82724A2252N020    | B82724J2252N020  | ×   | ×   |
| 2.5                 | 5.6                  | 55                           | 125                    | +60                  | B82724A2252N001    | B82724J2252N001  | ×   | ×   |
| 2.7                 | 6.6                  | 60                           | 110                    | +60                  | B82724A2272N020    | B82724J2272N020  | ×   | ×   |
| 3.0                 | 12.0                 | 110                          | 125                    | +40                  | B82724A2302N021    | B82724J2302N021  | ×   | ×   |
| 3.3                 | 5.6                  | 45                           | 95                     | +40                  | B82724A2332N001    | B82724J2332N001  | ×   | ×   |
| 4.0                 | 4.7                  | 40                           | 65                     | +60                  | B82724A2402N020    | B82724J2402N020  | ×   | ×   |
| 4.0                 | 3.3                  | 35                           | 65                     | +60                  | B82724A2402N001    | B82724J2402N001  | ×   | ×   |
| 4.8                 | 3.3                  | 35                           | 46                     | +70                  | B82724A2482N020    | B82724J2482N020  | —   | —   |
| 5.0                 | 2.5                  | 25                           | 38                     | +60                  | B82724A2502N001    | B82724J2502N001  | ×   | ×   |
| 5.1                 | 4.1                  | 30                           | 46                     | +60                  | B82724A2512N020    | B82724J2512N020  | ×   | ×   |
| 6.0                 | 3.3                  | 17                           | 25                     | +60                  | B82724A2602N041    | B82724J2602N041  | ×   | ×   |
| 6.0                 | 1.8                  | 20                           | 31                     | +40                  | B82724A2602N020    | B82724J2602N020  | ×   | ×   |
| 6.0                 | 1.0                  | 12                           | 23                     | +60                  | B82724A2602N001    | B82724J2602N001  | ×   | ×   |

× = approval granted

**Power line chokes** **B82724A/J**  
**Current-compensated ring core double chokes**

**Impedance  $|Z|$  versus frequency  $f$**   
 measured with windings in parallel at +20 °C,  
 typical values

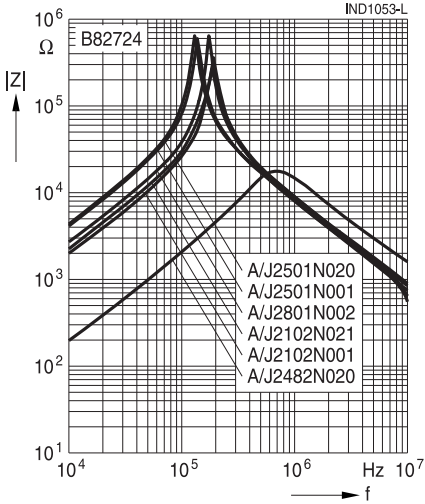

**Impedance  $|Z|$  versus frequency  $f$**   
 measured with windings in parallel at +20 °C,  
 typical values

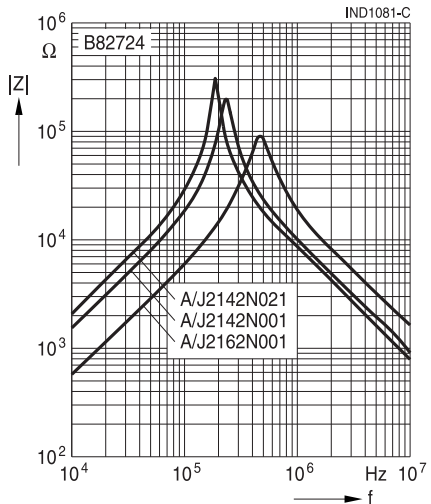

**Impedance  $|Z|$  versus frequency  $f$**   
 measured with windings in parallel at +20 °C,  
 typical values

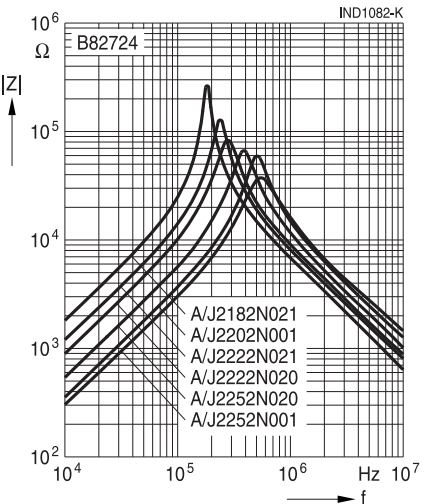

**Impedance  $|Z|$  versus frequency  $f$**   
 measured with windings in parallel at +20 °C,  
 typical values

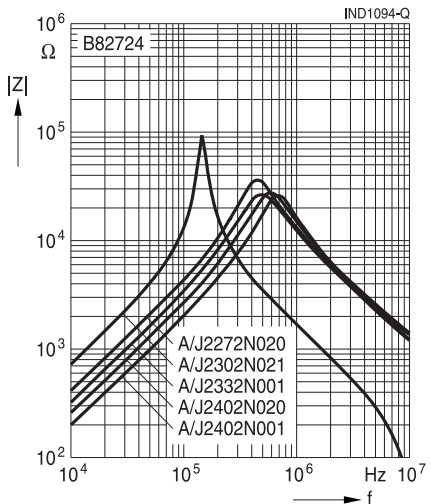

**Power line chokes** **B82724A/J**

---

**Current-compensated ring core double chokes**

**Impedance  $|Z|$  versus frequency  $f$**   
 measured with windings in parallel at +20 °C,  
 typical values

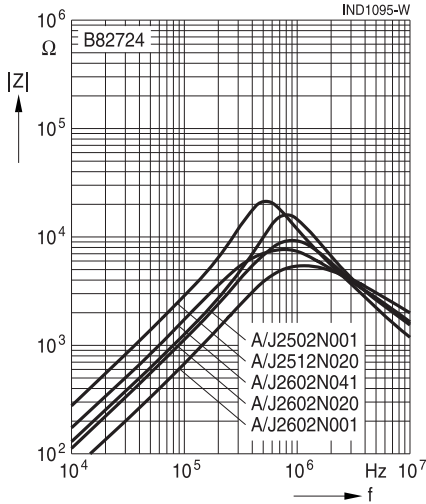

**Current derating  $I_{op}/I_R$**   
**versus temperature  $T_A$**

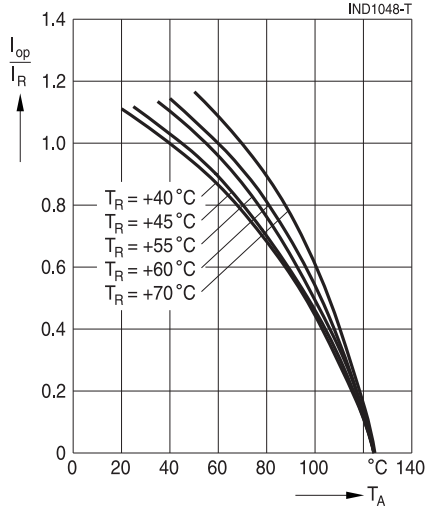

## Cautions and warnings

### Current-compensated ring core double chokes

- Please note the recommendations in our Inductors data book (latest edition) and in the data sheets.
  - Particular attention should be paid to the derating curves given there. Derating must be applied in case the ambient temperature in the application exceeds the rated temperature of the component.
  - Ensure the operation temperature (which is the sum of the ambient temperature and the temperature rise caused by losses / self-heating) of the component in the application does not exceed the maximum value specified in the climatic category.
  - The soldering conditions should also be observed. Temperatures quoted in relation to wave soldering refer to the pin, not the housing.
- If the components are to be washed varnished it is necessary to check whether the washing varnish agent that is used has a negative effect on the wire insulation, any plastics that are used, or on glued joints. In particular, it is possible for washing varnish agent residues to have a negative effect in the long-term on wire insulation.  
Washing processes may damage the product due to the possible static or cyclic mechanical loads (e.g. ultrasonic cleaning). They may cause cracks to develop on the product and its parts, which might lead to reduced reliability or lifetime.
- The following points must be observed if the components are potted in customer applications:
  - Many potting materials shrink as they harden. They therefore exert a pressure on the plastic housing or core. This pressure can have a deleterious effect on electrical properties, and in extreme cases can damage the core or plastic housing mechanically.
  - It is necessary to check whether the potting material used attacks or destroys the wire insulation, plastics or glue.
  - The effect of the potting material can change the high-frequency behaviour of the components.
- Ferrites are sensitive to direct impact. This can cause the core material to flake, or lead to breakage of the core.
- Even for customer-specific products, conclusive validation of the component in the circuit can only be carried out by the customer.



## Important notes

### Current-compensated ring core double chokes

The following applies to all products named in this publication:

1. Some parts of this publication contain **statements about the suitability of our products for certain areas of application**. These statements are based on our knowledge of typical requirements that are often placed on our products in the areas of application concerned. We nevertheless expressly point out **that such statements cannot be regarded as binding statements about the suitability of our products for a particular customer application**. As a rule, EPCOS is either unfamiliar with individual customer applications or less familiar with them than the customers themselves. For these reasons, it is always ultimately incumbent on the customer to check and decide whether an EPCOS product with the properties described in the product specification is suitable for use in a particular customer application.
2. We also point out that **in individual cases, a malfunction of electronic components or failure before the end of their usual service life cannot be completely ruled out in the current state of the art, even if they are operated as specified**. In customer applications requiring a very high level of operational safety and especially in customer applications in which the malfunction or failure of an electronic component could endanger human life or health (e.g. in accident prevention or life-saving systems), it must therefore be ensured by means of suitable design of the customer application or other action taken by the customer (e.g. installation of protective circuitry or redundancy) that no injury or damage is sustained by third parties in the event of malfunction or failure of an electronic component.
3. **The warnings, cautions and product-specific notes must be observed.**
4. In order to satisfy certain technical requirements, **some of the products described in this publication may contain substances subject to restrictions in certain jurisdictions (e.g. because they are classed as hazardous)**. Useful information on this will be found in our Material Data Sheets on the Internet ([www.epcos.com/material](http://www.epcos.com/material)). Should you have any more detailed questions, please contact our sales offices.
5. We constantly strive to improve our products. Consequently, **the products described in this publication may change from time to time**. The same is true of the corresponding product specifications. Please check therefore to what extent product descriptions and specifications contained in this publication are still applicable before or when you place an order.  
  
We also **reserve the right to discontinue production and delivery of products**. Consequently, we cannot guarantee that all products named in this publication will always be available. The aforementioned does not apply in the case of individual agreements deviating from the foregoing for customer-specific products.
6. Unless otherwise agreed in individual contracts, **all orders are subject to the current version of the "General Terms of Delivery for Products and Services in the Electrical Industry" published by the German Electrical and Electronics Industry Association (ZVEI)**.
7. The trade names EPCOS, BAOKE, Alu-X, CeraDiode, CeraLink, CSMP, CSSP, CTVS, DeltaCap, DigiSiMic, DSSP, FilterCap, FormFit, MiniBlue, MiniCell, MKD, MKK, MLSC, MotorCap, PCC, PhaseCap, PhaseCube, PhaseMod, PhiCap, SIFERRIT, SIFI, SIKOREL, SilverCap, SIMDAD, SiMic, SIMID, SineFormer, SIOV, SIP5D, SIP5K, ThermoFuse, WindCap are **trademarks registered or pending** in Europe and in other countries. Further information will be found on the Internet at [www.epcos.com/trademarks](http://www.epcos.com/trademarks).