

250 x 110 x 30 cm

98.4" x 43.3" x 11.8"

SIMONCLICK SUPERPLUS 6/300

5 Años Garantía
Years Guarantee
Jahre Garantie
Ans Garantie
Anos de Garantía
SIMONRACK



1200 kg
(2645 lb)
Total



Simon
Rack
SINCE 1964 - MANUFACTURER

ESTANTERIAS SIMON S.L. B. 60.566.463
PG. ALFAMEN C/ POLIGONO C. Nº3
ALFAMEN (ZARAGOZA)



www.simonrack.com



INSTRUCTIONS

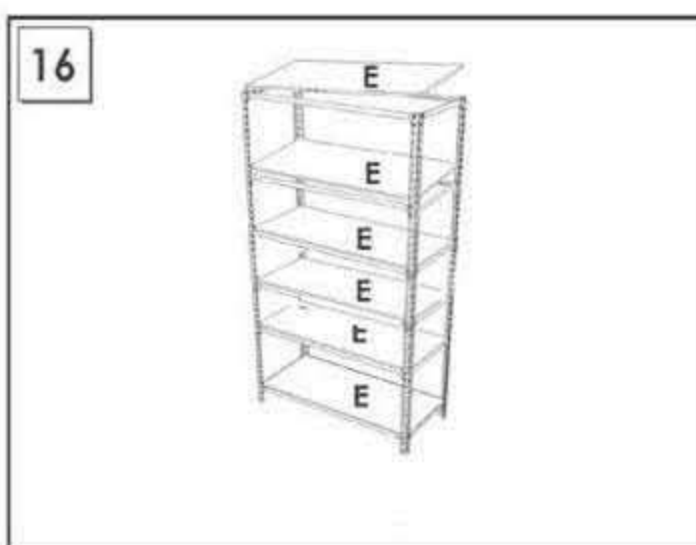
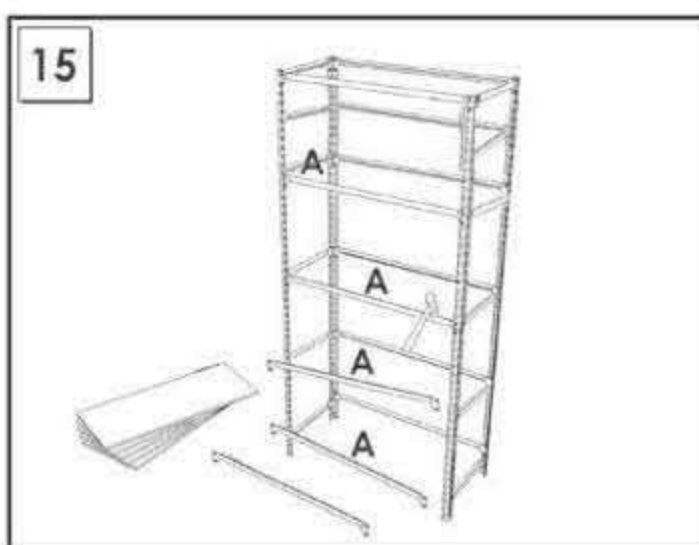
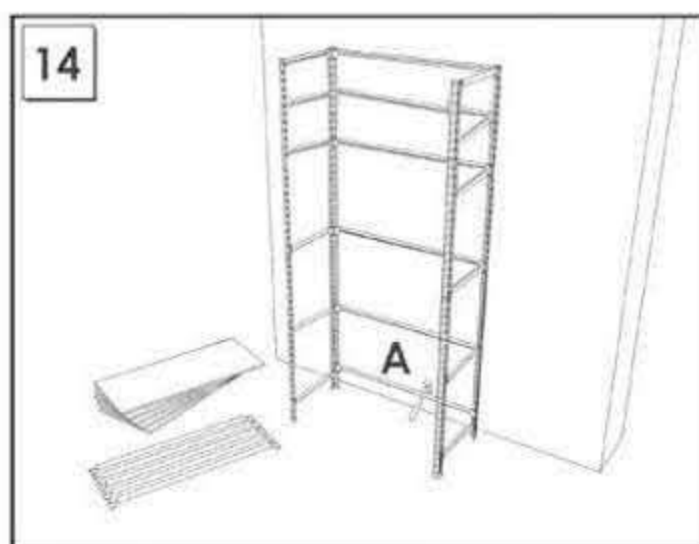
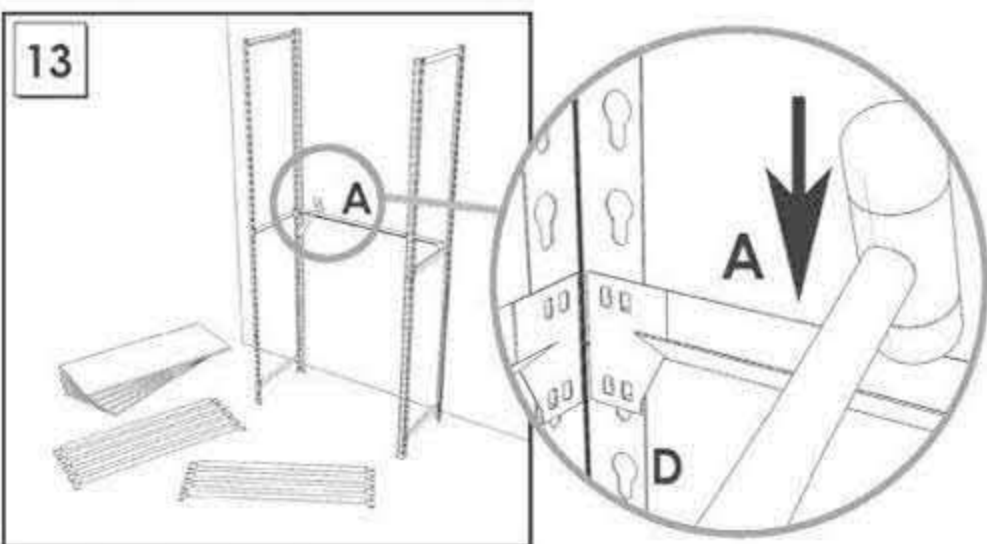
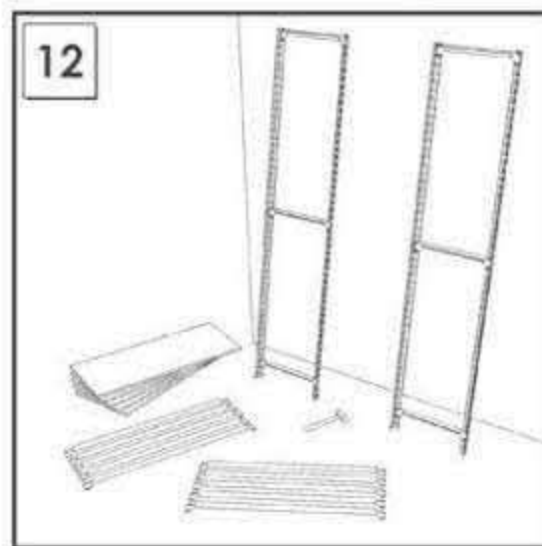
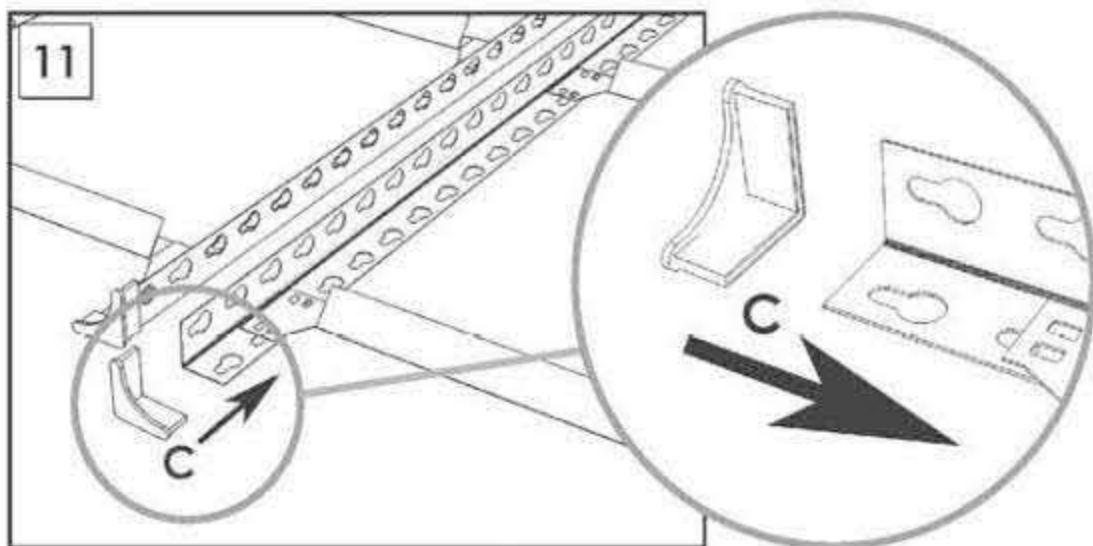
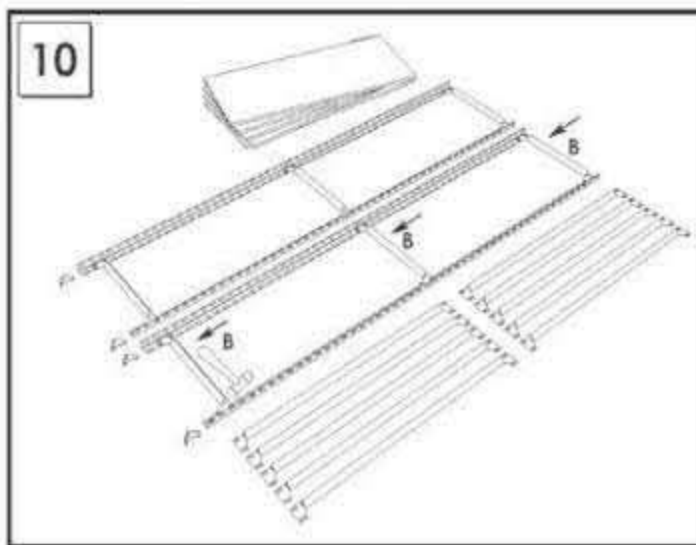
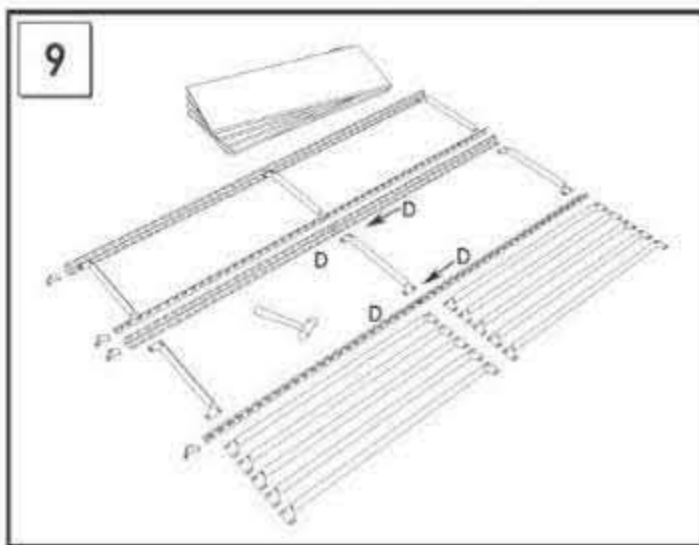
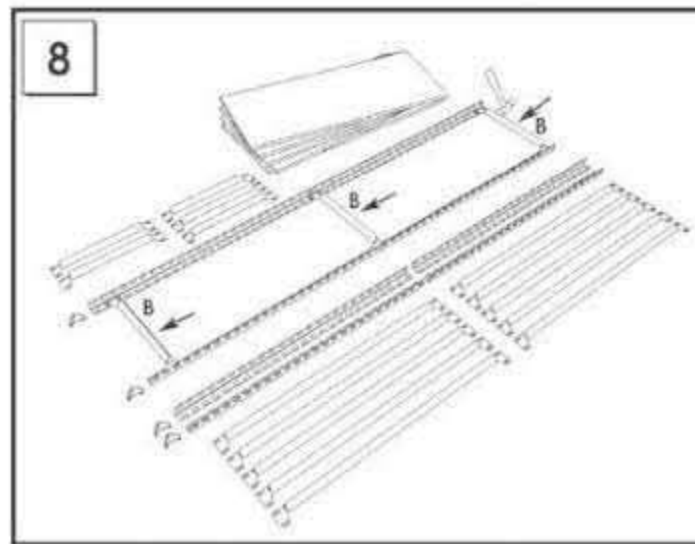
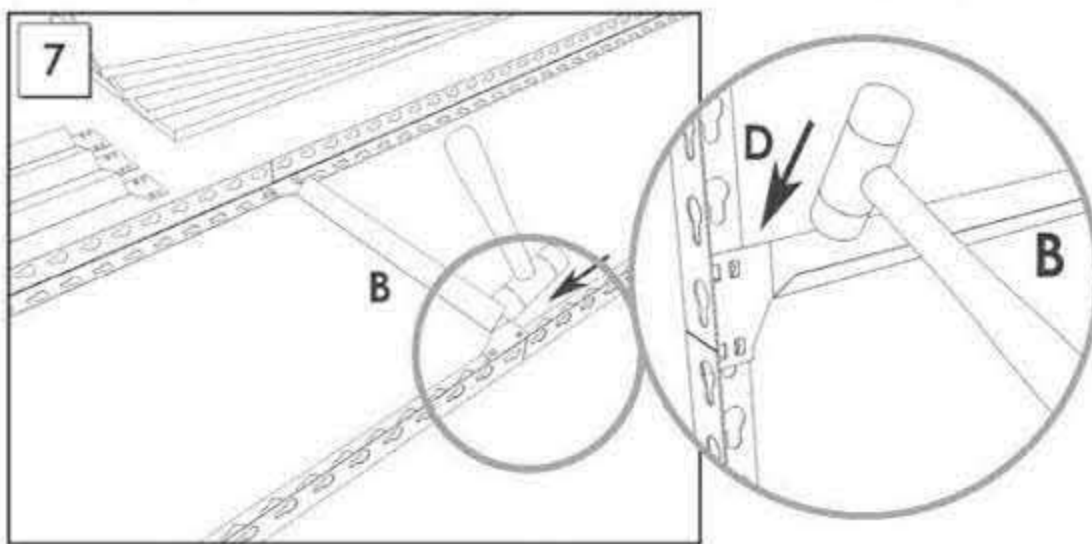
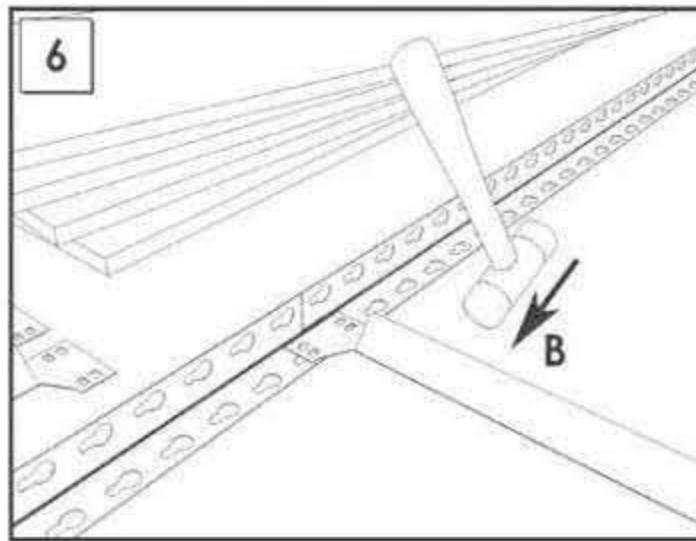
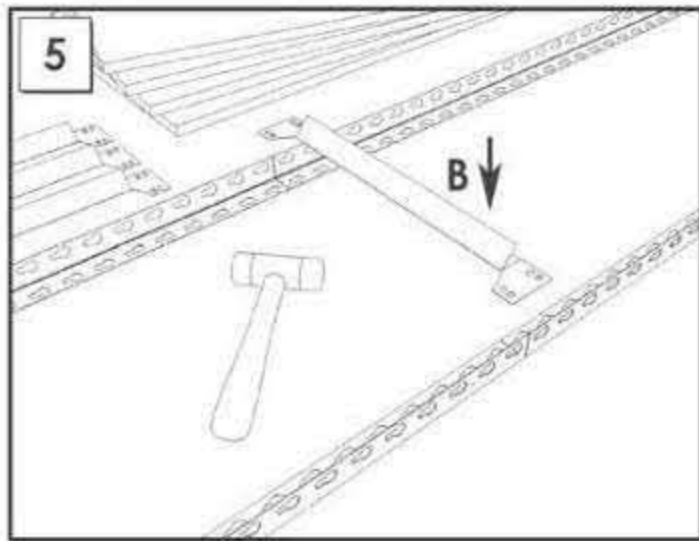
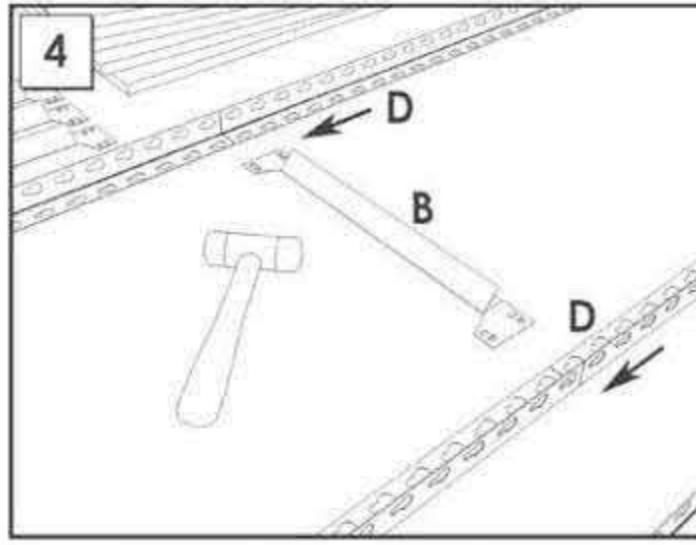
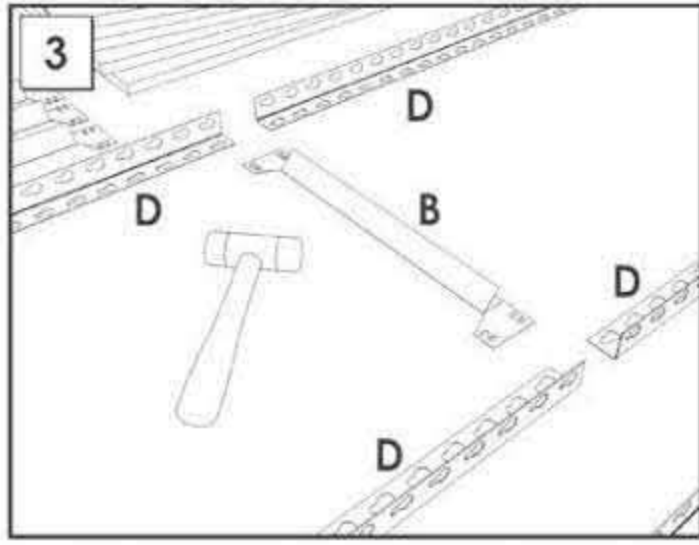
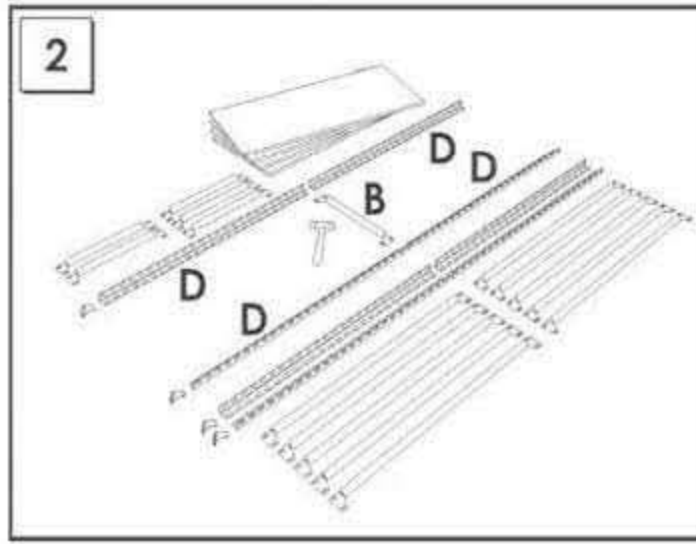
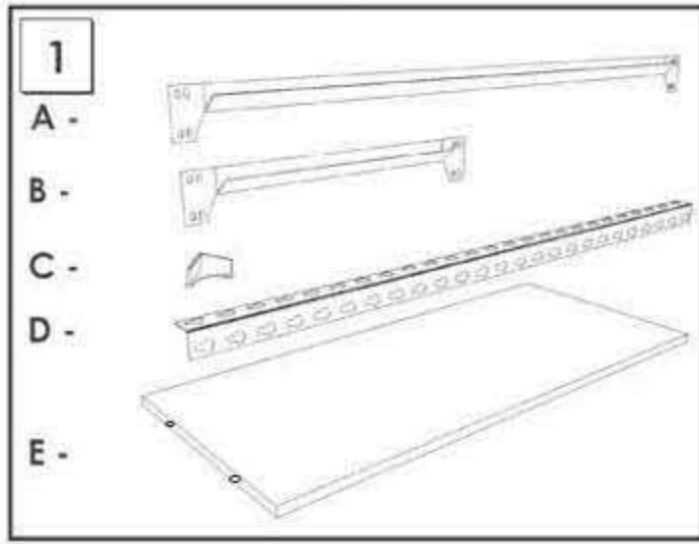

On-line instructions: www.instructionsrack.com/simonclick

SIMONCLASSIC



SIMONCLICK



SIMONOFFICE



SIMONTALLER



BANCOS DE TRABAJO WORK BENCHES



SIMONHOME



TAQUILLAS LOCKER



SIMONTITÁN



SIMONINOX



SIMONPALET



SIMONLEVER

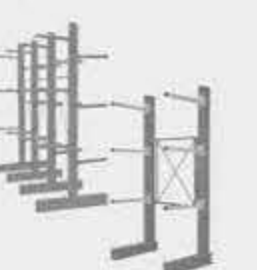

ALTILLOS Y PASILLOS ELEVADOS PLATFORMS AND MEZZANINES

