

# ALPS® ALPS ELECTRIC EUROPA GmbH

Customer : ALPS EUROPE Distribution

No: DMT-07-059

Attention :

Date: 23.10.07

Your ref.:

Your part No.:

## SPECIFICATION

### PURPOSE OF THIS DOCUMENT:

- Preliminary copy.  
 Request for your Approval.  
( New  Engineering Change)

Please sign and return one copy.

APPROVED BY                      Date:                     

### ALPS:

Model : **TACT SWITCH**

**SKHMQME010**

Spec. No: **KHM-703**

Sample No **780125324**

X

Name

Title

For Production

REMARKS:

Designed : R.Krüger

Approved T. Kato

ENG. DEPT. DORTMUND FACTORY

WERK DORTMUND · GISELHERSTRASSE 4 · 44319 DORTMUND · TELEFON 02 31/21 88-0 · FAX 02 31/21 88-199 · e-mail: alps-dortmund@alps-europe.com

Geschäftsführer:  
Yukio Sagisaka, Masataka Kataoka,  
Koichi Yamazaki, Koichi Otsuka

Amtsgericht Düsseldorf HRB 14717

Bankverbindungen:  
Deutsche Bank AG, Dortmund, (BLZ 440 700 50) Konto-Nr. 1219 690  
Westdeutsche Landesbank, Dortmund, (BLZ 440 500 00) Konto-Nr. 1364 348  
The Bank of Tokyo, Ltd. Düsseldorf, (BLZ 300 107 00) Konto-Nr. 0511 018 788  
Deutsche Bank AG, Düsseldorf, (BLZ 300 700 10) Konto-Nr. 2081 818

Hauptverwaltung:  
ALPS ELECTRIC EUROPA GmbH  
Hansaallee 203  
40549 Düsseldorf  
Tel. 02 11/59 77-0, Fax 59 77-146

FOLD

SYMB REVISIONS

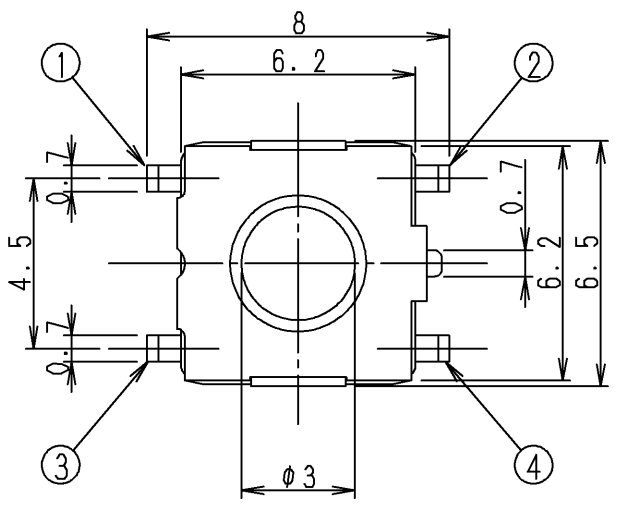

回路図  
CIRCUIT DIAGRAM

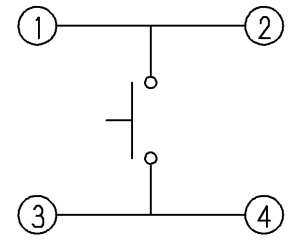

フ° リント基板ラント° 寸法  
PCB PATTERN DIMENSIONS  
(スイッチ取付け面より見る)  
(WHEN VIEWED FROM SWITCH MOUNTING FACE)

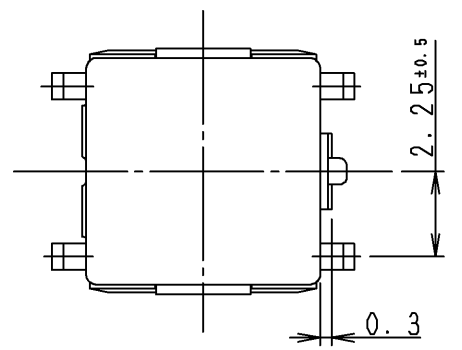
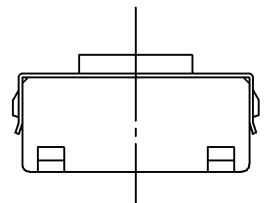
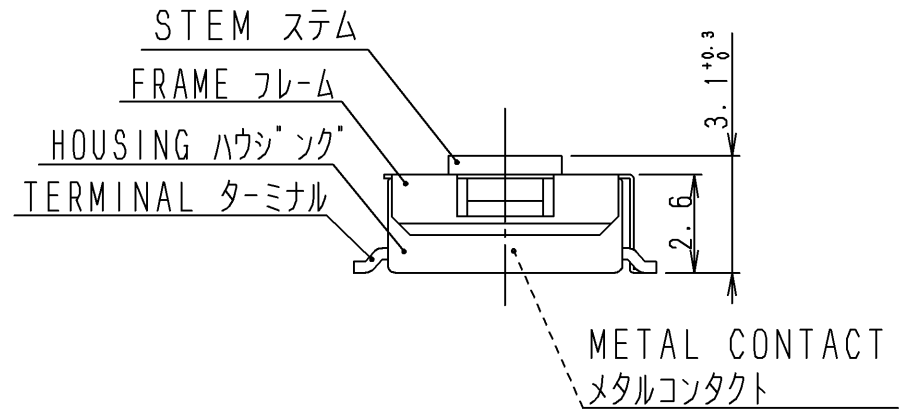
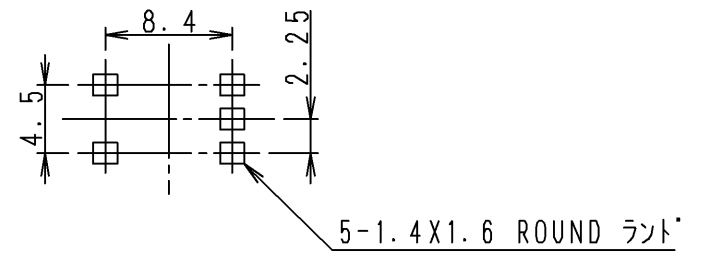

- 注記  
NOTE
1. ステム色調はレッドとする。  
STEM COLOR TO BE RED.
  2. 本品はテーピング包装されるものである。  
SWITCHES TO BE SUPPLIED IN TAPING PACKAGING.
  3. テーピング包装規格書はTHM-001による。  
TAPING SPECIFICATION TO BE ACCORDANCE WITH THM-001.

許容差の指定なき寸法公差		TOLERANCE UNLESS OTHERWISE SPEC.	
		BASIC DIMENSIONS	TOLERANCES
10以下	±0.3	UP TO 10	±0.3
10をこえ100未満	±0.5	ABOVE 10 TO 100	±0.5
100以上	±0.8	ABOVE 100	±0.8
角 度	±3°	ANGULAR DIMENSIONS	±3°

PART NO.		MATERIAL		SPEC/NAME		FINISH		REMARK	
<b>ALPS ELECTRIC CO., LTD.</b>									
DSGD. MAR. 24. 2006 DSG7				SCALE		NO.			
C. SAITO				5:1		SKHMOME010			
CHKD. MAR. 24. 2006 DSG7						TITLE			
H. KOZUMA						製品図 (PRODUCT DRAWING)			
APPD. MAR. 24. 2006. DSG7				UNIT		DOCUMENT NO.			
H. KOZUMA				mm		SKHMOME010.1100		.32	
NO.	SYMB	DATE	APPD	CHKD	DSGD				

A

B

D

BACKGROUND		
------------	--	--

I. General 一般事項

1.1 Application 適用範囲 This specification is applied to TACT switches which have no keypad. この規格書は、キートップなしのタクトスイッチについて適用する。

1.2 Operating temperature range 使用温度範囲: -40 ~ +85 °C (normal humidity, normal air pressure 常湿・常圧)

1.3 Storage temperature range 保存温度範囲: -40 ~ +90 °C (normal humidity, normal air pressure 常湿・常圧)

1.4 Test conditions 試験状態 Unless otherwise specified, the atmospheric conditions for making measurements and tests are as follows. 試験及び測定は特に規定がない限り以下の標準状態のもとで行う。  
 Normal temperature 常 温: (Temperature 温度 5~35°C)  
 Normal humidity 常 湿: (Relative humidity 湿度 25~85%)  
 Normal air pressure 常 圧: (Air pressure 気圧 86~106kPa)  
 If any doubt arise from judgement, tests shall be conducted at the following conditions. ただし、判定に疑義を生じた場合は以下の基準状態で行う。  
 Ambient temperature 温 度: 20±2°C  
 Relative humidity 相対湿度: 60~70%  
 Air pressure 気 圧: 86~106kPa

2. Appearance, style and dimensions 外観、形状、寸法

2.1 Appearance 外観 There shall be no defects that affect the serviceability of the product. 性能上有害な欠陥があってはならない。

2.2 Style and dimensions 形状、寸法 Refer to the assembly drawings. 製品図による。

3. Type of actuating 動作形式 Tactile feedback タクティールフィードバック

4. Contact arrangement 回路形式 1 poles 1 throws 1 回路 1 接点  
 (Details of contact arrangement are given in the assembly drawings 回路の詳細は製品図による)

5. Ratings 定格

5.1 Maximum ratings 最大定格 12 V DC 50mA

5.2 Minimum ratings 最小定格 1 V DC 10 μ A

6. Electrical specification 電気的性能

Items	項目	Test conditions	試験条件	Criteria	判定基準
6.1	Contact resistance 接触抵抗	Applying a below static load to the center of the stem, measurements shall be made. スイッチ操作部中央に下記の静荷重を加え、測定する。 (1) Depression 押圧力: <u>4.7 N</u> (2) Measuring method 測定方法: 1 KHz small-current contact resistance meter or voltage drop method at 5VDC 10mA. 1kHz 微小電流接触抵抗計、又は DC5V 10mA 電圧降下法		100m Ω Max.	
6.2	Insulation Resistance 絶縁抵抗	Measurements shall be made following the test set forth below: 下記条件で試験を行った後、測定する。 (1) Test voltage 印加電圧: <u>100 V DC</u> for 1 min. (2) Applied position 印加場所: Between all terminals. And if there is a metal Frame, between terminals and ground(frame) 端子間、金属フレームがある場合は、端子と金属フレーム間		100M Ω Min.	
6.3	Voltage proof 耐電圧	Measurements shall be made following the test set forth below: 下記条件で試験を行った後、測定する。 (1) Test voltage 印加電圧: <u>250 V AC</u> (50~60Hz) (2) Duration 印加時間: 1 min (3) Applied position 印加場所: Between all terminals. And if there is a metal Frame, between terminals and ground(frame) 端子間、金属フレームがある場合は、端子と金属フレーム間		There shall be no breakdown. 絶縁破壊のないこと。	

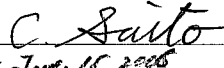
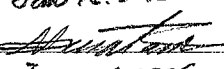
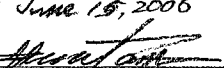
PAGE	SYMB	BACKGROUND	DATE	APPD	CHKD	DSGD	DSGD. Jun. 15, 2006  CHKD. June 15, 2006  APPD. June 15, 2006 
------	------	------------	------	------	------	------	--

DOCUMENT No. KHM-703	TITLE 製品仕様書	PRODUCT SPECIFICATIONS	PAGE 2/7
-------------------------	----------------	------------------------	-------------

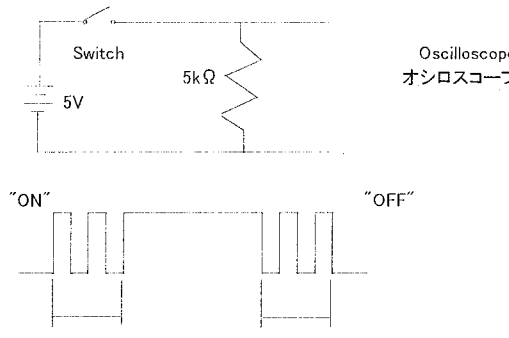
Items 項目	Test conditions 試験条件	Criteria 判定基準
6.4 Bounce バウンス	<p>Lightly striking the center of the stem at a rate encountered in normal use (3 to 4 operations per s), bounce shall be tested at "ON" and "OFF". スイッチ操作部の中央部を通常の使用状態(3~4回/秒)で軽く打鍵し、ON時及びOFF時のバウンスを測定する。</p> 	<p>ON bounce : <u>5 ms</u> Max. OFF bounce : <u>5 ms</u> Max.</p>

7. Mechanical specification 機械的性能		
Items 項目	Test conditions 試験条件	Criteria 判定基準
7.1 Operating force 作動力	<p>Placing the switch such that the direction of switch operation is vertical and then gradually increasing the load applied to the center of the stem, the maximum load required for the switch to come to a stop shall be measured. スイッチの操作方向が垂直になる様にスイッチを設置し、操作部中央部に徐々に荷重を加え、操作部が停止するまでの最大荷重を測定する。</p>	<u>2.35 ± 0.69</u> N
7.2 Travel 移動量	<p>Placing the switch such that the direction of switch operation is vertical and then applying a below static load to the center of the stem, the travel distance for the switch to come to a stop shall be measured. スイッチの操作方向が垂直になる様にスイッチを設置し、操作部中央部に以下の静荷重を加え、操作部が停止するまでの距離を測定する。 (1) Depression 押圧力 : <u>4.7</u> N</p>	<u>0.25 + 0.2 / -0.1</u> mm
7.3 Return force 復帰力	<p>The sample switch is installed such that the direction of switch operation is vertical and upon depression of the stem in its center the travel distance, the force of the stem to return to its free position shall be measured. スイッチの操作方向が垂直になる様にスイッチを設置し、操作部中央部を移動量押圧後、操作部が復帰する力を測定する。</p>	<u>0.49</u> N Min
7.4 Stop strength ストッパー強度	<p>Placing the switch such that the direction of switch operation is vertical and then a below static load shall be applied in the direction of stem operation. スイッチの操作方向が垂直になる様にスイッチを設置し、スイッチの操作方向へ以下の静荷重を加える。 (1) Depression 押圧力 : <u>29.4</u> N (2) Time 時間 : <u>60</u> s</p>	There shall be no sign of damage mechanically and electrically. 機械的、電気的に異常のないこと。
7.5 Stem strength ステム抜去強度	<p>Placing the switch in a manner that the operational direction of switch shall be vertical. Then, the maximum value in withstanding the pull strength applied opposite to the operational direction of stem shall be measured. スイッチの操作方向が垂直になる様にスイッチを設置し、操作部の操作方向とは反対方向に操作部を引っ張って抜けない力である。</p>	<u>29.4</u> N

8. Environmental specification 耐候性能		
Items 項目	Test conditions 試験条件	Criteria 判定基準
8.1 Resistance to low Temperatures 耐寒性	<p>Following the test set forth below the sample shall be left in normal temperature and humidity conditions for 1 h before measurements are made: 次の試験後、常温、常湿中に1時間放置後測定する。 (1) Temperature 温度 : <u>-40 ± 2</u> °C (2) Time 時間 : <u>96</u> h (3) Waterdrops shall be removed. 水滴は取り除く。</p>	Item 6. Item 7.1 Item 7.2
8.2 Heat resistance 耐熱性	<p>Following the test set forth below the sample shall be left in normal temperature and humidity conditions for 1 h before measurements are made: 次の試験後、常温、常湿中に1時間放置後測定する。 (1) Temperature 温度 : <u>+90 ± 2</u> °C (2) Time 時間 : <u>96</u> h</p>	Item 6. Item 7.1 Item 7.2

DOCUMENT No. KHM-703	TITLE PRODUCT SPECIFICATIONS 製品仕様書	PAGE 3/7
-------------------------	--	-------------

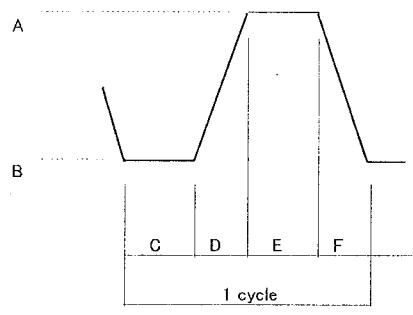
Items 項目	Test conditions 試験条件	Criteria 判定基準
8.3 Moisture Resistance 耐湿性	<p>Following the test set forth below the sample shall be left in normal temperature and humidity conditions for 1 h before measurements are made: 次の試験後、常温、常湿中に1時間放置後測定する。</p> <p>(1) Temperature 温度: <math>+60 \pm 2</math> °C (2) Time 時間: 96 h (3) Relative humidity 相对湿度: 90 ~ 95 % (4) Waterdrops shall be removed. 水滴は取り除く。</p>	<p>Contact resistance 接触抵抗(Item 6.1): 200 mΩ Max. Insulation resistance 絶縁抵抗(Item 6.2): 10 MΩ Min. Item 6.3 Item 6.4 Item 7.1 Item 7.2</p>
8.4 Change of Temperature 温度サイクル	<p>After below cycles of following conditions, the switch shall be allowed to stand under normal room temperature and humidity conditions for 1 h, and measurement shall be made. Water drops shall be removed. 下記条件で以下回数のサイクル試験後、常温常湿中に1時間放置し測定する。ただし、水滴は取り除く。</p> <p>(1) Number of cycles サイクル数: 5 cycles 回</p>  <p>A = <math>+90</math> °C B = <math>-40</math> °C C = 2 h D = 1 h E = 2 h F = 1 h</p>	<p>Item 6. Item 7.1 Item 7.2</p>

9. Endurance specification 耐久性能

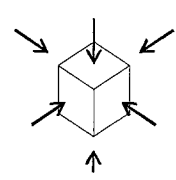
Items 項目	Test conditions 試験条件	Criteria 判定基準
9.1 Operating life 動作寿命	<p>Measurements shall be made following the test set forth below: 下記条件で試験を行った後、測定する。</p> <p>(1) 12 VDC 5 mA resistive load 抵抗負荷 (2) Rate of operation 動作速度: 2 to 3 operations per s 回/秒 (3) Depression 押圧力: 3.04 N (4) Cycles of operation 動作回数: 200,000 cycles 回</p>	<p>Contact resistance 接触抵抗(Item 6.1): 200 mΩ Max. Insulation resistance 絶縁抵抗(Item 6.2): 10 MΩ Min. Bounce バウンス(Item 6.4): ON bounce: 10 ms Max. OFF bounce: 10 ms Max. Operating force 作動力(Item 7.1): <math>-30 \sim +30</math> % of initial force 初期値に対して Item 6.3 Item 7.2</p>
9.2 Vibration Resistance 耐振性	<p>Measurements shall be made following the test set forth below: 下記条件で試験を行った後、測定する。</p> <p>(1) Vibration frequency range 振動数範囲: 10 ~ 55 Hz (2) Total amplitude 全振幅: 1.5 mm (3) Sweep ratio 掃引の割合: 10-55-10 Hz Approx. 1 min 約1分 (4) Method of changing the sweep vibration frequency: Logarithmic or uniform 掃引振動数の変化方法 対数又は一様掃引 (5) Direction of vibration: Three mutually perpendicular directions, including 振動の方向 the direction of the travel スイッチ操作方向を中心とした垂直3方向 (6) Duration 振動時間: 2 h each (6 h in total) 各2時間(計6時間)</p>	<p>Item 6. Item 7.1 Item 7.2</p>
9.3 Shock 耐衝撃性	<p>Measurements shall be made following the test set forth below: 下記条件で試験を行った後、測定する。</p> <p>(1) Acceleration 加速度: 784 m/s<sup>2</sup> (2) Acting time 作用時間: 11 msec (3) Test direction 試験方向: 6 directions 6面 (4) Number of shocks 試験回数: 3 times per direction (18 times in total) 各方向各3回(計18回)</p> 	<p>Item 6. Item 7.1 Item 7.2</p>

DOCUMENT No. KHM-703	TITLE PRODUCT SPECIFICATIONS 製品仕様書	PAGE 4/7
-------------------------	--	-------------

10. Soldering conditions 半田付条件

Items 項目	Recommended conditions 推奨条件
10.1 Hand soldering 手半田	<p>Please practice according to below conditions. 以下の条件にて実施して下さい。</p> <p>(1) Soldering temperature 半田温度 : 350 °C Max. (2) Continuous soldering time 連続半田時間 : 3 s Max. (3) Capacity of soldering iron 半田コテ容量 : 60 W Max. (4) Excessive pressure shall not be applied to the terminal. 端子に異常加圧のないこと (5) Safeguard the switch assembly against flux penetration from its top side. スイッチの上面からフラックスが侵入しない様にしてください。</p>
10.2 Reflow soldering リフロー半田	<p>Please practice according to below conditions. 以下の条件にて実施して下さい。</p> <p>(1) Profile 温度プロファイル</p> <p>Surface of product Temperature 部品表面温度(°C)</p> <p>(2) Allowable soldering time 半田回数 : 2 time Max. (The temperature shall go down to a normal temperature in prior to exposure to the second time : 2回を行う場合には、スイッチが常温に戻ってから行うこと。)</p>
10.3 Other precautions For soldering 半田付けに関する その他注意事項	<p>(1) Switch terminals and PCB. Upper face shall be free from flax prior to soldering. 事前にスイッチの端子及びプリント基板の部品実装面上にフラックスが塗られていないこと。</p> <p>(2) Following the soldering process, do not try to clean the switch with a solvent or the like. 半田付け後、溶剤などでスイッチを洗浄しないで下さい。</p> <p>(3) Recommended cream solder : M705-GRN360-K2(SENJU METAL INDUSTRY CO.,LTD) or equivalent 推奨クリーム半田 : 千住金属工業(株) M705-GRN360-K2 同等品</p> <p>(4) When chip components is soldered on the back side of PCB by automatic flow soldering, after this switch soldered by reflow soldering, flux will possibly creep up at the exterior wall of the housing and penetrate into the housing due to flux ejection. Therefore, when the PCB is designed, please do not locate through holes adjacent to the switch mounted area. 本スイッチをリフロー半田後、プリント基板裏面をディップ半田して使用する場合は、ディップ時のフラックス吹き上げ等によりスイッチ側面からフラックスがはい上がる場合がありますので、パターン設計にあたってはスイッチ下面、周囲にスルーホールを設けしないで下さい。</p> <p>(5) As the conditions vary somehow depending on the kind of reflow soldering equipment, please make sure you have the right one before use. リフロー槽の種類により、多少条件が異なりますので、事前に十分確認の上使用してください。</p> <p>(6) As the click rate may deteriorate when heat is applied repeatedly, reflow soldering should be performed in the shortest period and at the lowest temperature possible. 熱履歴が加わるとクリック感が低下する可能性がありますので極力低温短時間でリフローを行うようにお願いします。</p> <p>(7) Safeguard the switch assembly against flux penetration from its top side. スイッチの上面からフラックスが浸入しないようにして下さい。</p> <p>(8) The thickness of Cream Solder : 0.15mm クリーム半田印刷厚 : 0.15mm</p>

DOCUMENT No.	TITLE	PRODUCT SPECIFICATIONS	PAGE
KHM-703		製品仕様書	5/7

【Precaution in use】ご使用上の注意

A. General 一般項目

A1. This product has been designed and manufactured for general electronic devices, such as audio devices, visual devices, home electronics, information devices and communication devices. In case this product is used for more sophisticated equipment requiring higher safety and reliability, such as life support system, space & aviation devices, disaster prevention & security system, please make verification of conformity or check on us for the details.

本製品はオーディオ機器、映像機器、家電機器、情報機器、通信機器などの一般電子機器用に設計・製造したものです。生命維持装置、宇宙・航空機器、防災・防犯機器などの高度な安全性や信頼性が求められる用途に使用される場合は、貴社にて適合性の確認を頂くか、当社へご確認ください。

A2. This product is designed and manufactured assuming that it is to be used with the resistance for direct current. If you use other kinds of Resistance (inductive (L) or capacitive (C)), please let us know beforehand.

本製品は直流の抵抗負荷を想定して設計・製造されています。その他の負荷(誘導性負荷(L)、容量性負荷(C))で使用される場合は、別途ご相談ください。

B. Soldering and assemble to PC board process 半田付、基板実装工程

B1. Note that if the load is applied to the terminals during soldering they might suffer deformation and defects in electrical performance.

端子をはんだ付けされる場合、端子に荷重が加わりますと条件によりガタ、変形及び電気的特性劣化のおそれがありますのでご注意ください。

B2. Conditions of soldering shall be confirmed under actual production conditions.

はんだ付けの条件の設定については、実際の量産条件で確認されるをお願いします。

B3. If the stem is given stress from the side, it may result in damages to switch functions. Therefore please handle it with extreme care.

When the switch is carried, any shock shall not be applied to the stem.

ステムに横からの力が加わりますと、スイッチの機能破壊につながる危険性がありますので取扱いは十分注意して下さい。

移動する場合はステムに衝撃が加わらない様に注意して下さい。

B4. As this TACT switch is designed for reflow soldering, if you place it at the edge of PCB for convenience, then flux may get into the sliding part of the SW during automatic dip soldering after being mounted, so do not apply auto dip after being mounted.

当タクトスイッチはリフロー半田対応ですが、スイッチ実装後にオートディップを行う場合にスイッチが基板の端にあるとフラックスが浸入する恐れがありますので、十分にご注意下さい。

B5. When this switch is mounted by the chip mounter, it can be dispositioned because the body turns on the way to the PCB if you vacuum the top side of the stem. Therefore we recommend that the stem should be vacuumed by the so called "escape part of the frame".

本スイッチをチップマウンターにより実装する場合は、ステム天面をバキュームされますと基板マウントまでの課程でボディが回転して位置がずれる場合がありますのでステムを逃げフレーム部をバキュームして頂くことをお勧めします。

B6. As the click rate may deteriorate when heat is applied repeatedly, reflow soldering should be done within the recommended conditions.

熱履歴が加わるとクリック感が低下する可能性がありますので推奨リフロー条件以内でリフローを行う様にお願いします。

C. Washing process 洗浄工程

C1. Following the soldering process, do not try to clean the switch with a solvent or the like.

半田付け後、溶剤等でスイッチを洗浄しないでください。

D. Mechanism design (switch layout) 機構設計

D1. The dimensions of a hole and pattern for mounting a printed circuit board shall refer to the recommended dimensions in the engineering drawings.

プリント基板取付穴及びパターンは、製品図に記載されている推奨寸法をご参照下さい。

D2. You may dip-solder chip components on the backside of PCB after you have reflow-soldered this switch. However, dip-soldering may cause flux to creep up on the wall of the housing and penetrate the switch. Therefore, do not design a throughhole under and around the switch.

本スイッチをリフロー半田後、プリント基板裏面をディップ半田して使用する場合は、ディップ時のフラックス吹き上げ等により、スイッチ側面より、フラックスがはい上がる場合がありますので、パターン設計にあたっては、スイッチ下面、周囲にスルーホールを設けないで下さい。

D3. Do not use the switch in a manner that the stem will be given stress from the side. If you push the stem from the side, the switch may be broken.

ステムを横方向から押す様な使い方は避けて下さい。ステム先端に横方向から荷重が加わりますとスイッチが破壊される場合があります。

D4. Press the center of the stem. Click feel may be changed, if you press the edge. This is because the center will be displaced, depending on the hinge structure or cumulative tolerances. When you use the hinge structure, take special care so that the keytop point to press the switch won't move.

ステムのセンターを押す様にして下さい。ヒンジ構造及びセット上の累積公差によるセンターズレなどステムを端押しする状態では感触が変化する場合があります。ヒンジ構造の場合は、押下時ステム押し位置が移動しますので、特にご注意下さい。

D5. This switch is designed for unit construction that it is pressed by human operation. Please avoid using this switch as mechanical detecting function. In case such detecting function is required, please consult with our detector switch section.

当スイッチは、直接人の操作を介してスイッチを押す構造にてご使用ください。メカ的な検出機能へのご使用は避けてください。

検出機能には弊社検出スイッチを使用してください。

D6. The switch will be broken, if you give larger stress than specified. Take most care not to let the switch be given larger stress than specified.

(Refer to the strength of the stopper.)

スイッチ操作時に規定以上の荷重が加わるとスイッチが破損する場合があります。スイッチに規定荷重以上の力が加わらない様にご注意下さい。

(ストッパー強度参照)

DOCUMENT No. KHM-703	TITLE 製品仕様書	PRODUCT SPECIFICATIONS	PAGE 6/7
-------------------------	----------------	------------------------	-------------

E. Using environment 使用環境

E1. Foreign matter invaded from outside. 外部浸入物

Since this switch does not have sealed structure, it may have contact failure caused by the dust from outside up to the environment.  
当スイッチは密閉構造ではありませんので、使用環境によっては塵埃が内部に侵入し、接点障害を起こす場合があります。

When you use this switch, precaution must be taken against the dust.

The followings are examples of dust invasion:

ご使用の際はスイッチに異物が侵入しないようご注意ください。

以下に塵埃侵入例を示します。ご参考にして下さい。

- ① Debris from the cut or hole of PCB in process, or wastes from the PCB protection material (e.g. newspaper, foamed polystyrene etc.) invaded the switch.  
工程内における基板切断面や穴から発生するクズやPCB保護材(新聞紙、発泡スチロール等)から出るゴミがスイッチに侵入した。

- ② Flux or powdered flux produced by stacking PCB's or excess foaming invaded the switch.  
基板重ねによりフラックス粉末がスイッチに侵入した。

※ When you need higher dust-proof, make selection among the switches of dust-proof types in our catalog.  
より高い防塵性が必要な場合は、当社カタログより防塵タイプのスイッチを選定しご使用願います。

Dusty environment 塵埃環境

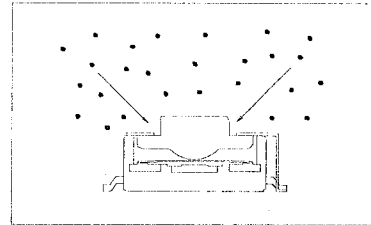

“—” Indicates the route of invasion.  
“—”は侵入経路を示します。

E2. In case this product is always used around a sulfurate hot spring where sulfide gas is generated or in a place where exhaust gas from Automobiles exists, take most care due to the switch performance might be affected.

硫黄系温泉地等常時ガスが発生する場所や自動車等の排気ガスの発生する場所で常時使用する場合、当製品の性能に影響を及ぼすおそれがありますので十分にご注意下さい。

E3. Follow the directions if you have parts/materials described below within the module where the switch is installed.

同一セット内に以下の様な部材に關しましては以下の点にご注意願います。

- For parts, rubber materials, adhesive agents, plywood, packing materials and lubricant used for the mechanical part of the device, do not use Those ones that may generate gas of sulfurization or oxidation.  
部品、ゴム材料、接着剤、合板、機器の梱包材、機器内の駆動部に使用される潤滑剤については、硫化、酸化ガスを発生しないものを採用してください。
- When you use silicon rubber, grease, adhesive agents and oil, use those that will not generate low molecular siloxane gas. The low molecular Siloxane gas may form silicon dioxide coat on the SW contact part, resulting in the contact failure.  
シリコン系ゴム、グリース、接着剤、オイルを使用される場合は、低分子シロキサンガスを発生しないものを使用してください。低分子シロキサンガスが発生しますとSW接点部に2酸化珪素の被膜を形成して接点障害を引き起こす場合があります。
- When you apply chemical agents such as coating agents to the products, please let us know beforehand.  
製品のコーティング剤等の薬品を付着させる場合は、別途ご相談ください。

E4. Do not use this switch in the atmosphere with high humidity or with bedewing probability, because such atmosphere may cause leak among terminals.

高湿度環境下、又は結露する可能性がある環境では、端子間の電流リークが発生する可能性がありますので本スイッチはご使用にならないでください。

F. Storage method. 保管方法

F1. If you don't use the product immediately, store it as delivered in the following environment: with neither direct sunshine nor corrosive gas and in normal temperatures, normal humidity. However, it is recommended that you should use it as soon as possible before six months pass.

製品は納入形態のまま常温、常湿で直射日光の当たらず腐食性ガスが発生しない場所に保管し納入から6ヶ月以内を限度として出来るだけ早くご使用ください。

F2. After you break the seal, you should put the remaining in a plastic bag to separate it from the outside and store it in the same environment mentioned above. You should use it up as soon as possible.

開封後はポリフクロで外気との遮断を図り上記と同じ環境下で保管しすみやかにご使用下さい。

F3. Do not stack too many switches for strafe.

過剰な積み重ねは行わないで下さい。

G. Others. その他

G1. This specification will be invalid one year after it is issued, if you don't return it or don't place an order.

本仕様書は発行日より1年間を経過して、ご返却又はご発注の無い場合は、無効とさせていただきます。

G2. Please understand that the specifications other than electric and mechanical characteristics and outside dimensions may be changed at our own Discretion.

電気的、機械的特性、外觀寸法および取付寸法以外につきましては、当社の都合により変更させて頂く事が有りますので、あらかじめ御了承下さい。

G3. Never use the product beyond the rating. It may catch fire. If you think that the product may be used beyond the rating due to some abnormal

Conditions, you must take certain protective measures, such as a protective circuit to shut down the current.  
定格を超えての使用は火災発生のおそれがありますので絶対に避けて下さい。また異常使用等で定格を超える恐れがある場合は保護回路等で電流遮断等の対策をして下さい。

G4. The flammability grade of the plastic used for this product is "94HB" by the UL Standard (slow burning). Therefore, either refrain from using it in the place where it can catch fire, or take measures to preclude catching fire.

本製品に使用している樹脂等の燃焼グレードはUL規格の"94HB"(遅燃性グレード)相当を使用しております。つきましては類焼の恐れがある場所での使用を禁止するか、類焼防止対策をお願いします。



DOCUMENT No.	TITLE	PAGE
KHM-703	PRODUCT SPECIFICATIONS 製品仕様書	7/7

G5. Though we are confident in switch quality, we cannot deny the possibility that they could fail due to short or open circuit.

Therefore, if you use a switch for a product requiring higher safety level, we would like you to verify in advance what effects your Module would receive in case the switch alone should fail. And secure safety as a whole system by introducing the fail-safe design, i.e. a protection network.

スイッチの品質には万全を尽くしていますが故障モードとしてショート、オープンが発生が皆無とは言えません。安全性が重視されるセットの設計に際しては、SWの単品故障にたいしてセットとしての影響を事前にご検討いただき、保護回路、等のフェールセーフ設計のご検討を十分に行い安全を確保して頂きますようにお願いします。

CLASS.NO.	TITLE
	TAPE PACKAGING SPECIFICATION

**1.Scope**

This specification covers the requirements of the taping packaging for SKHM standard type of TACT switches.

**2.Packaging Materials**

Item	Description
Package	Cartons
Reel	<del>Core: Foamed Polyethylene</del> <sup>(B) ADD</sup> <del>Sideboard: Cartons</del> <sup>or Plastics</sup> <span style="float: right;">Delete</span>
Carrier Tape	Polypropylene
Cover Tape	Polyester

**3.Packaging Quantity**

**3.1.The number of the reels.**

Ten(10)reels at maximum,which contain 30000 switches, shall be packed in a package.

**3.2.The number of the switches.**

3000 switches shall be packed in a reel.

△ 3.3. It should be noted that we regard 2 cartons mentioned above as one package for export.

**4.Tape Form and Dimensions**

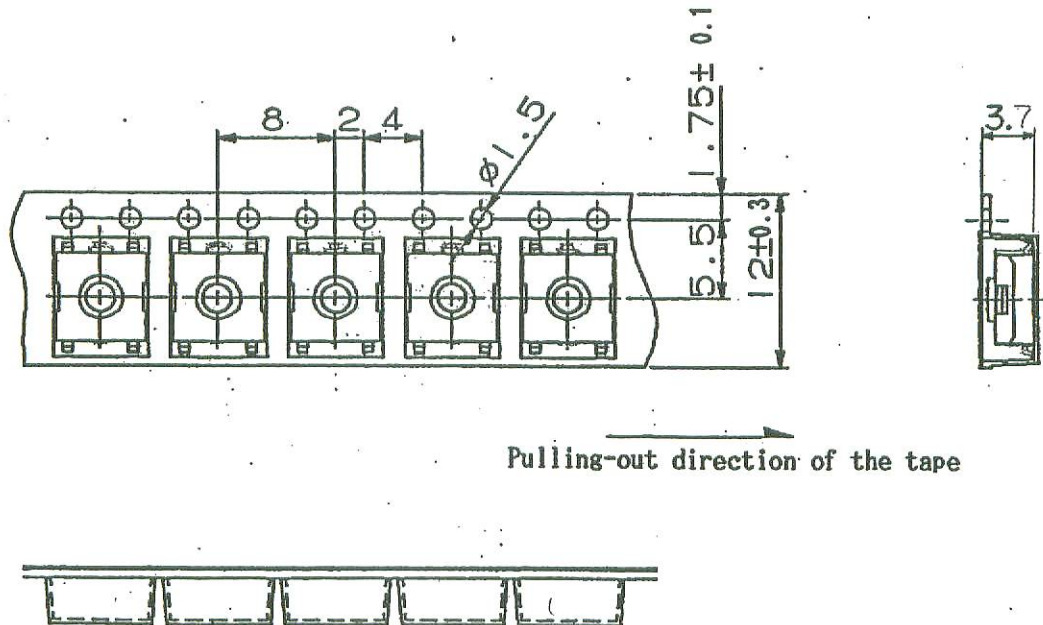

<b>ALPS ELECTRIC CO., LTD.</b>					
1/2, 2/2	B2	5-26-04	Y. Ono	K. Kame	Y. Takahashi
2/2	A2	Aug 29 '00	Y. Ono	K. Kame	Y. Takahashi
1/2	△-1	9-21-95	Y. Ono	Y. Takahashi	E. Ito
1/2	△-1	8-30-94	Y. Ono	K. Kame	Y. Takahashi
PAGE	SYMB.	DATE	APPD.	CHKD.	DSGD.
			189 9/3		Mar. 3 '89
					TAPE PACKAGING SPECIFICATION
					DOCUMENT NO.
					THM-001 (1/2)

CLASS.NO.	TITLE	
	TAPE PACKAGING SPECIFICATION	

5. Reel Form and Dimensions

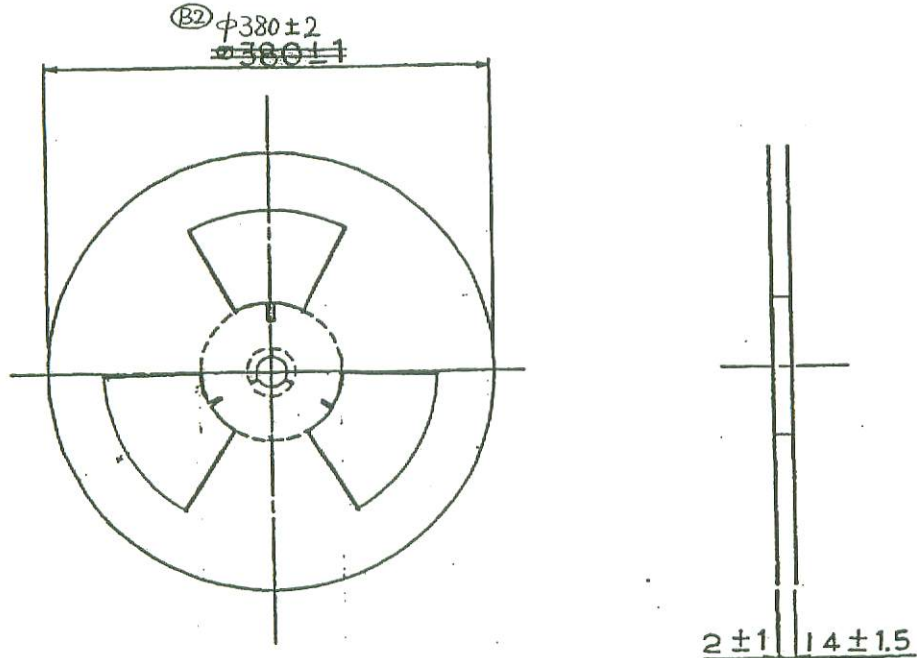

6. Packaging Procedure

6-1. At the beginning of reeling, the end of the tape, 200mm or more, shall be empty and fit into the groove in the reel core.

6-2. After reeling, the end of the tape, 130±4mm, shall be empty and the tape edge shall be cut in 45°.

The cover tape shall be extended 250±10mm from the tape edge and fixed with tape.

6-3. Total number of missing switches shall be ~~less than 10~~ <sup>(A1) 0</sup> in one reel.

~~(A2) Cut (Three consecutive switches may be missing.)~~

7. Storage Condition

7-1. Storage Environment

-20 to 50 °C, 20 to 85 %RH.

(Storage in high temperature and high humidity shall be avoided.)

						<b>ALPS ELECTRIC CO., LTD.</b>			
						APPD.	CHKD.	DSGD.	TAPE PACKAGING SPECIFICATION
						189 3/3		Mar. 3, 89	
PAGE	SYMB.	DATE	APPD.	CHKD.	DSGD.	B. Suzuki		J. Takahashi	DOCUMENT NO.
									THM-001 (2/2)

# RELIABILITY TEST REPORT

## 信頼性試験データ

TACT SWITCH タクトスイッチ

Model No.: SKHM(2.35N)

TEST ITEMS 試験項目	QUANTITY 試料数	JUDGMENT 判定
1. Operating life 動作寿命	n=20keys	OK
2. Resistance to low temperatures 耐寒性	n=20keys	OK
3. Heat resistance 耐熱性	n=20keys	OK
4. Moisture resistance 耐湿性	n=20keys	OK
5. Change of temperature 温度サイクル	n=20keys	OK
6. Vibration resistance 耐振性	n=20keys	OK
7. Shock 耐衝撃性	n=20keys	OK
8. Stop strength ストッパー強度	n=20keys	OK
9. Stem strength ステム抜去強度	n=20keys	OK
10. Hand soldering 手はんだ	n=20keys	OK
11. Reflow soldering リフローはんだ	n=20keys	OK

QUALITY ASSURANCE GROUP FURUKAWA PLANT MECHATRONIC DEVICES DIVISION	APPROVED BY <i>J. Terajima</i>	CHECKED BY <i>H. Abe</i>	TESTED BY <i>m. Ishikawa</i>
---	-----------------------------------	-----------------------------	---------------------------------

## Operating life 動作寿命

### 1. Test conditions and criteria 試験条件及び判定基準

Number of samples: 20

Test conditions 試験条件	Criteria 判定条件
Resistance load 負荷: DC 12V 5mA	Contact resistance 接触抵抗:INI. 100m MAX
Depression 押圧: 3.04N/key	FIN. 200m MAX
Rate of operations 打鍵速度: 3 Operations/s	Bounce(ON/OFF) バウンス:INI.5ms MAX FIN.10ms MAX
Cycles of operation 動作回数: 200,000 cycles	Operating force 作動力:INI. 2.35 ± 0.69 N
	FIN. INI ± 30% N
	Return force 復帰力: 0.49 N MIN
	Travel 移動量: 0.25+0.2/-0.1 mm

### 2. Measured value 測定結果

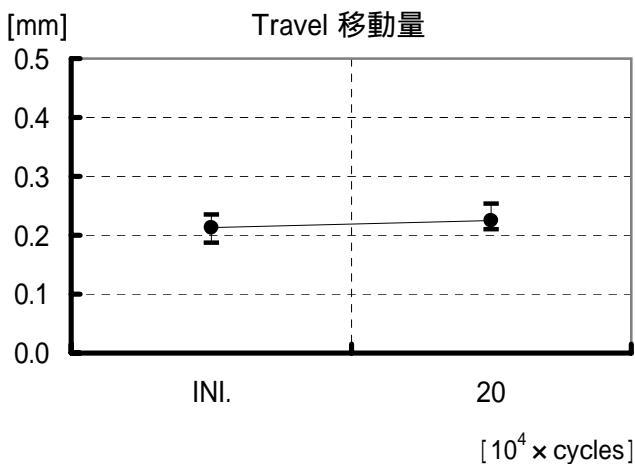
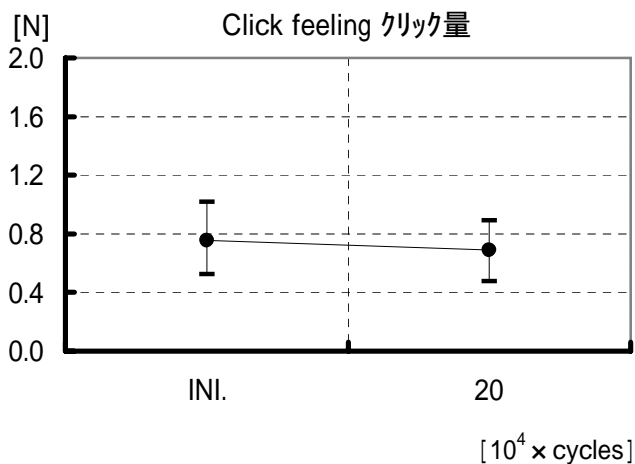
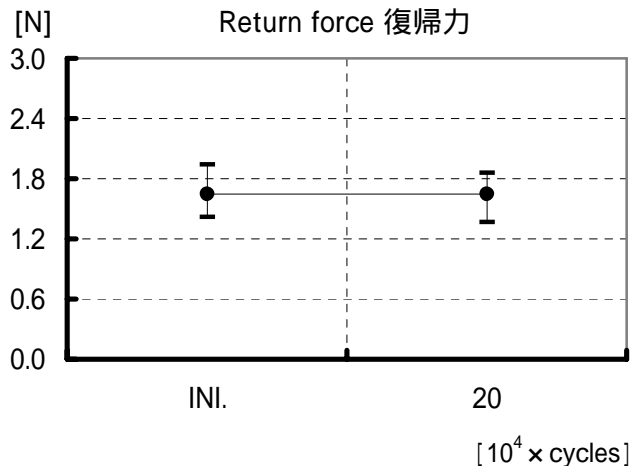
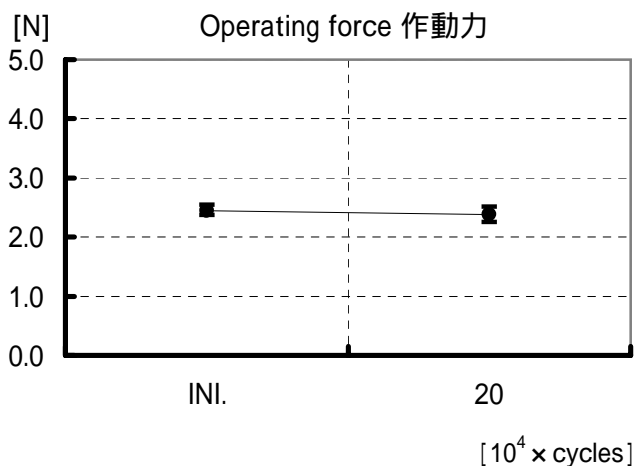
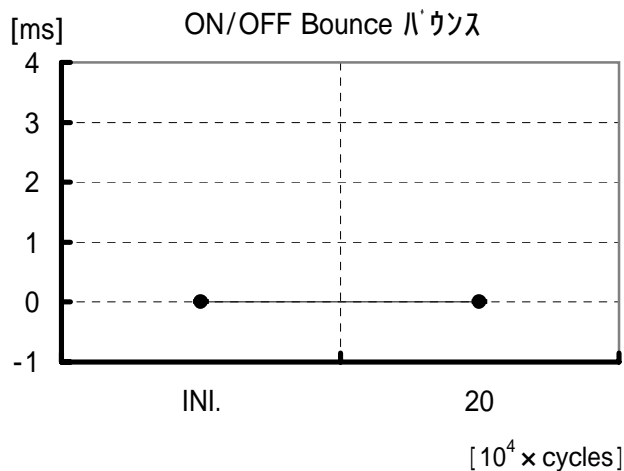
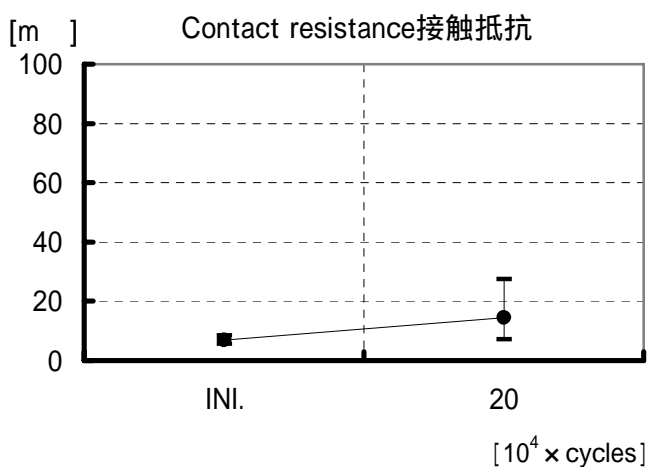

Sample conditions:

## Resistance to low temperatures 耐寒性

### 1. Test conditions and criteria 試験条件及び判定基準

Number of samples: 20

Test conditions 試験条件	Criteria 判定条件
(1)Temperature 温度: -40	Contact resistance 接触抵抗: 100m MAX
(2)Time 時間: 96h	Bounce(ON/OFF) バウンス: 10 ms MAX
	Operating force 作動力: 2.35 ± 0.69 N
	Return force 復帰力: 0.49 N MIN
	Travel 移動量: 0.25+0.2/-0.1 mm

### 2. Measured value 測定結果

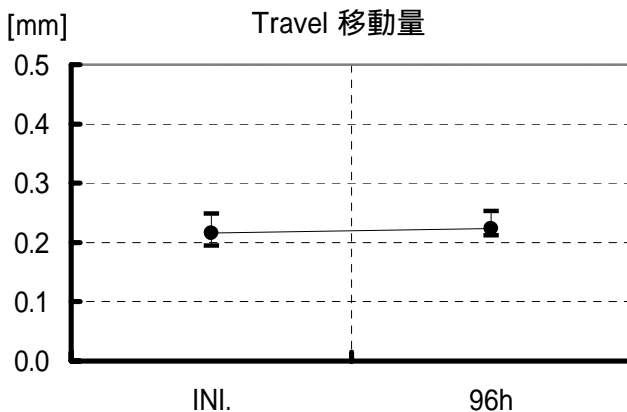
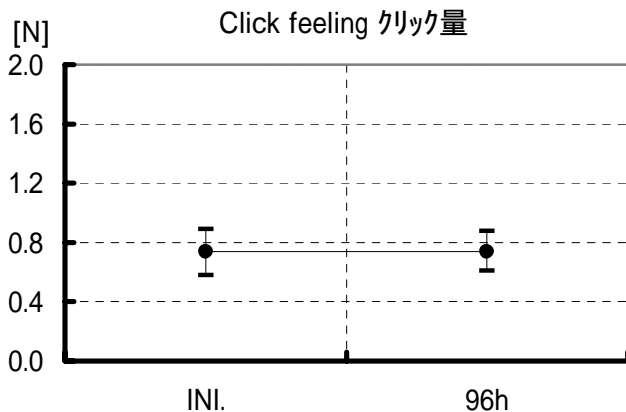
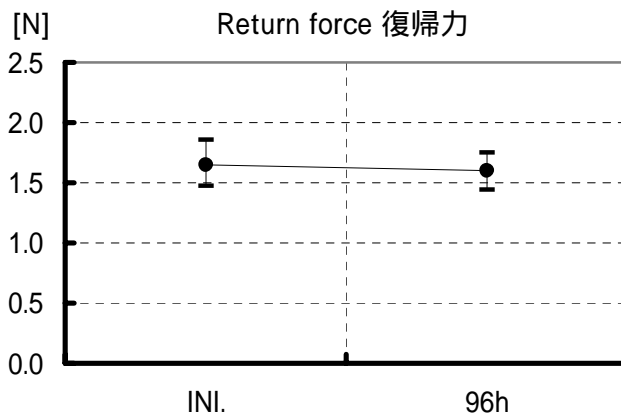
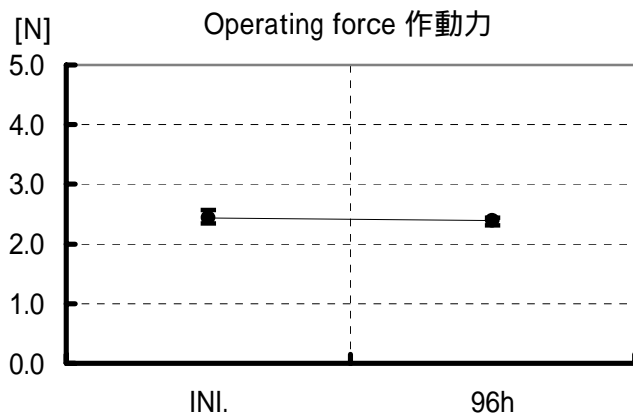
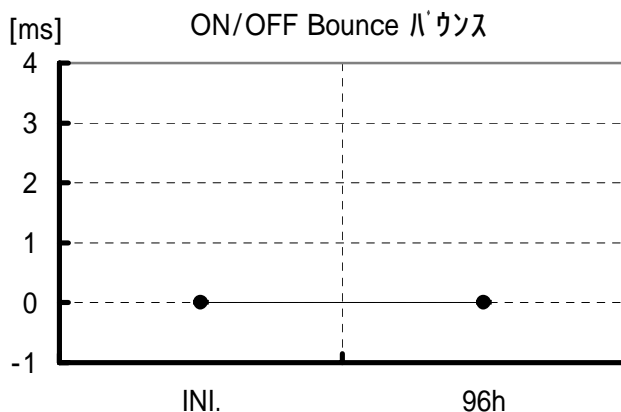
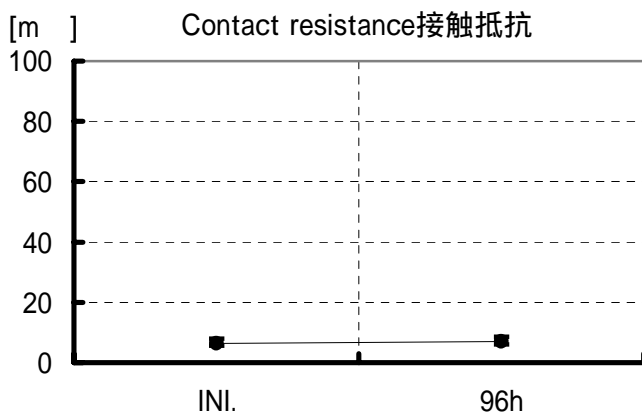

## Heat resistance 耐熱性

### 1. Test conditions and criteria 試験条件及び判定基準

Number of samples: 20

Test conditions 試験条件	Criteria 判定条件
(1)Temperature 温度: 90	Contact resistance 接触抵抗: 100m MAX
(2)Time 時間: 96h	Bounce(ON/OFF) バウンス: 10 ms MAX
	Operating force 作動力: 2.35 ± 0.69 N
	Return force 復帰力: 0.49 N MIN
	Travel 移動量: 0.25+0.2/-0.1 mm

### 2. Measured value 測定結果

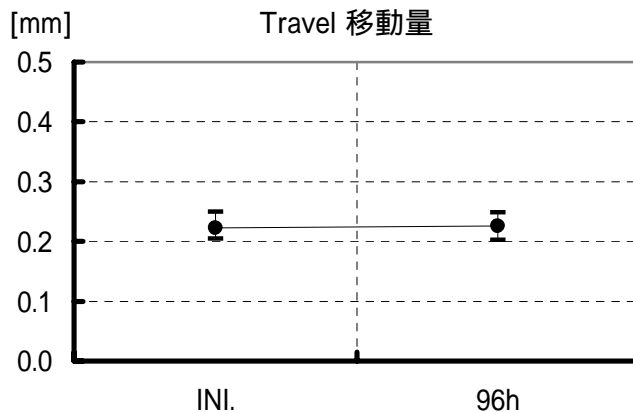
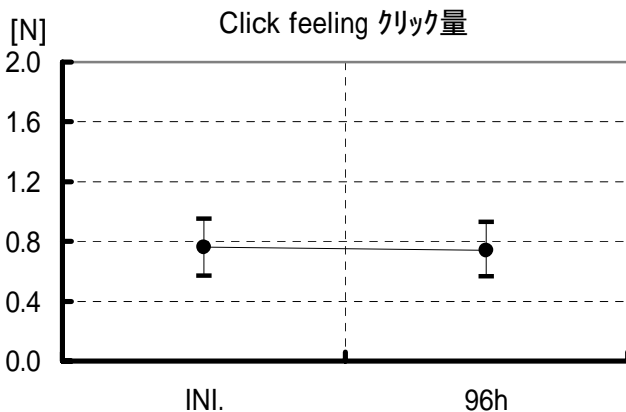
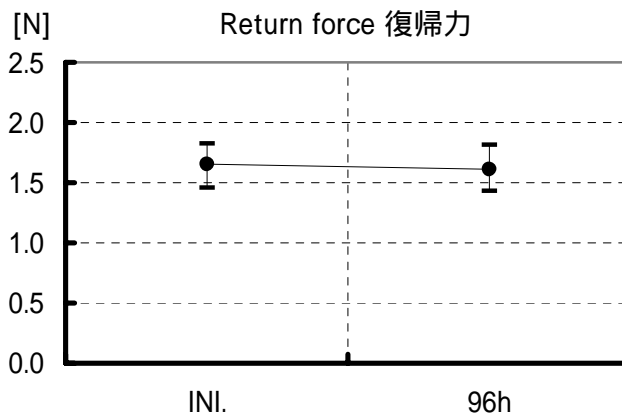
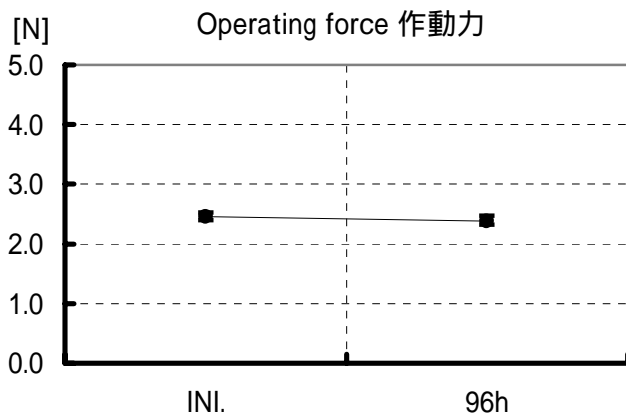
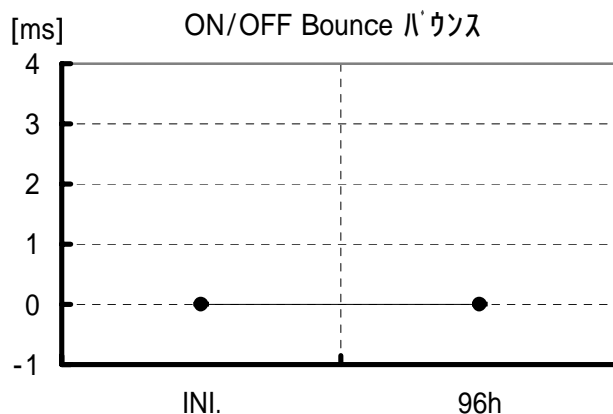
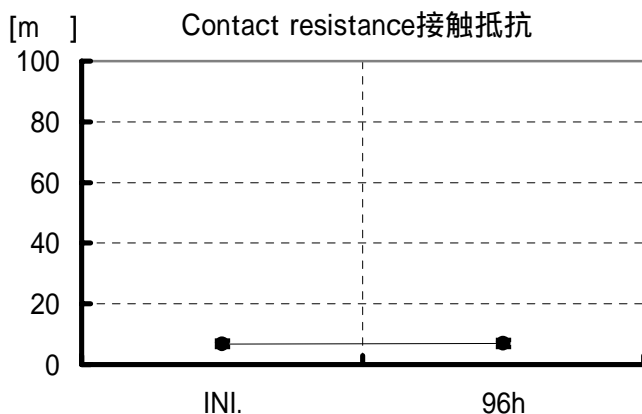

Sample conditions:

## Moisture resistance 耐湿性

### 1. Test conditions and criteria 試験条件及び判定基準

Number of samples: 20

Test conditions 試験条件	Criteria 判定条件
(1)Temperature 温度: 60	Contact resistance 接触抵抗:INI. 100m MAX
(2)Relative humidity 相对湿度: 90 ~ 95%	FIN. 200m MAX
(3)Time 時間: 96h	Bounce(ON/OFF) バウンス: 10 ms MAX
	Operating force 作動力: 2.35 ± 0.69 N
	Return force 復帰力: 0.49 N MIN
	Travel 移動量: 0.25+0.2/-0.1 mm

### 2. Measured value 測定結果

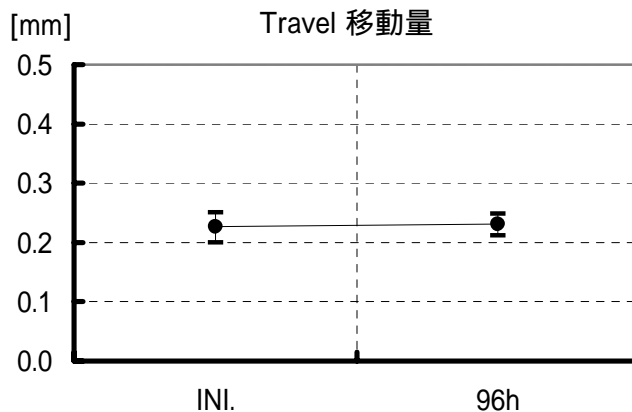
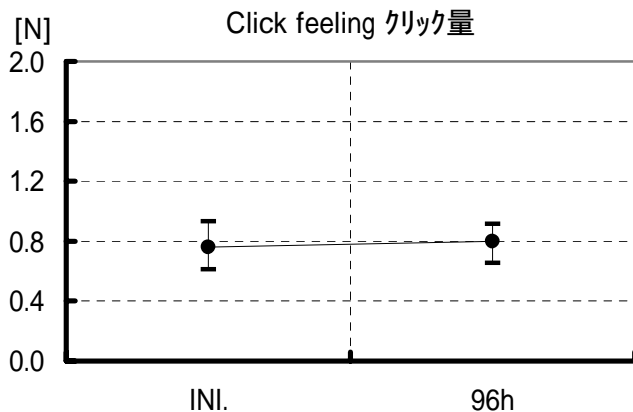
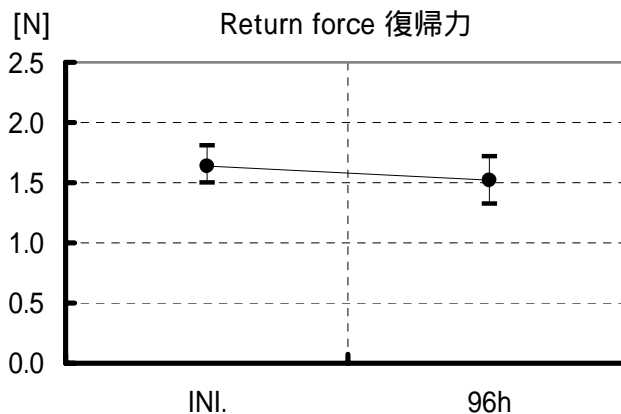
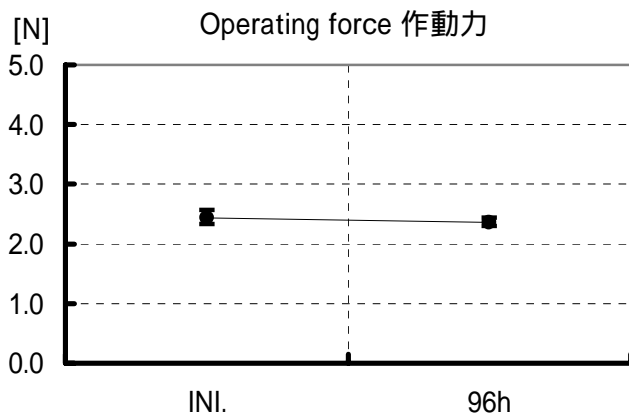
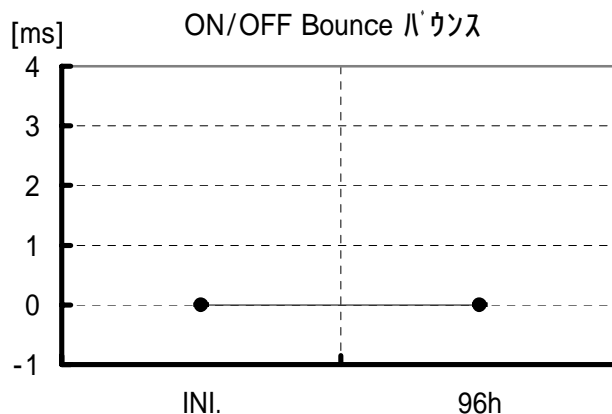
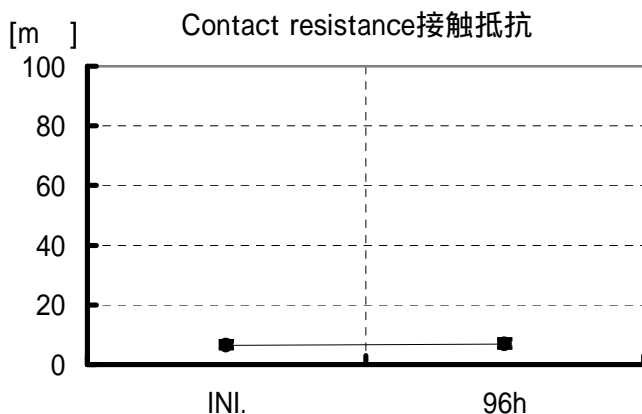



## Change of temperature 温度サイクル

### 1. Test conditions and criteria 試験条件及び判定基準

Number of samples: 20

Test conditions 試験条件	Criteria 判定条件
<p>× 5cycles</p>	<p>Contact resistance 接触抵抗: 100m MAX                      Bounce(ON/OFF) バウンス: 10 ms MAX                      Operating force 作動力: 2.35 ± 0.69 N                      Return force 復帰力: 0.49 N MIN                      Travel 移動量: 0.25+0.2/-0.1 mm</p>

### 2. Measured value 測定結果

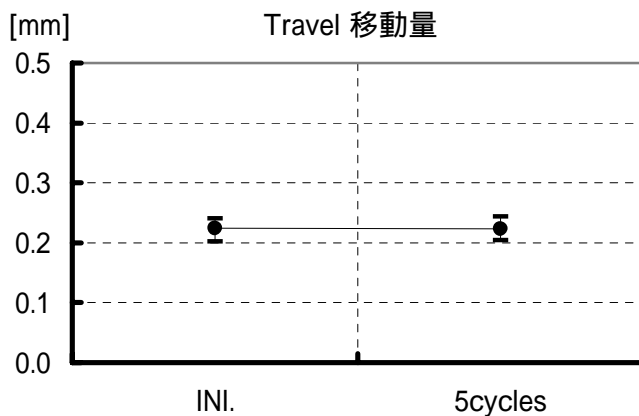
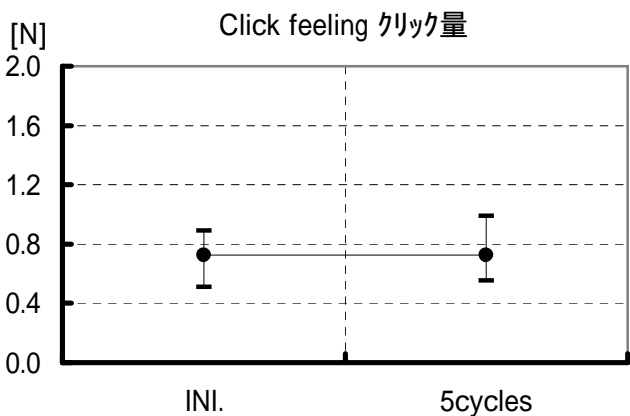
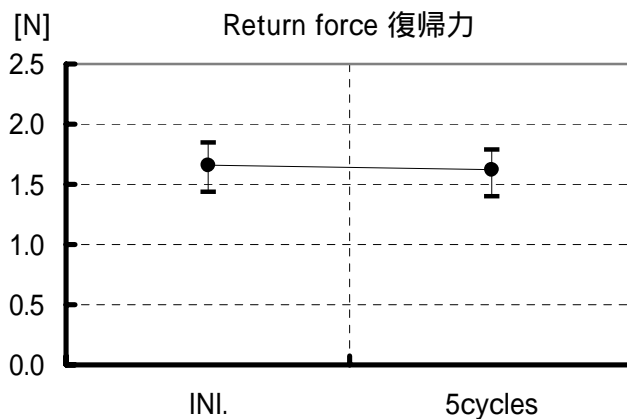
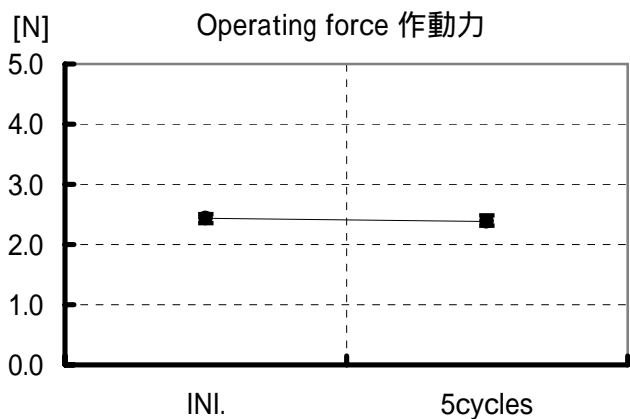
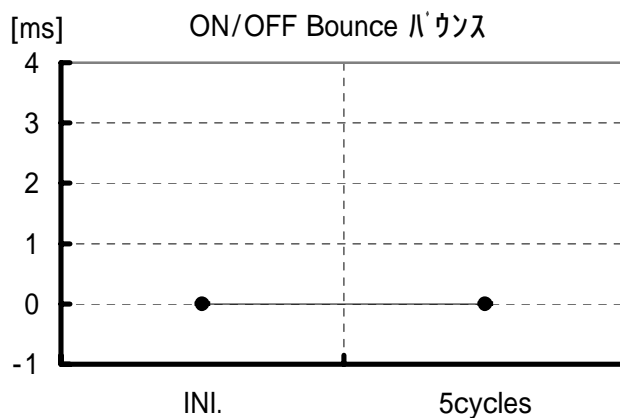
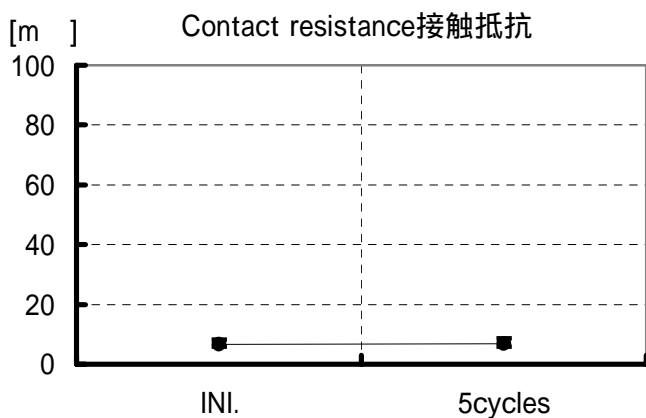

## Vibration resistance 耐振性

### 1. Test conditions and criteria 試験条件及び判定基準

Number of samples: 20

Test conditions 試験条件	Criteria 判定条件
10 ~ 55 ~ 10 Hz per 1 min Total amplitude 全振幅: 1.5mm Three mutually perpendicular directions, including the direction of the travel. スイッチ操作方向を中心とした垂直3方向 2h each (6h in total) 各2時間(計6時間)	Contact resistance 接触抵抗: 100m MAX Bounce(ON/OFF) バウンス: 10 ms MAX Operating force 作動力: 2.35 ± 0.69 N Return force 復帰力: 0.49 N MIN Travel 移動量: 0.25+0.2/-0.1 mm

### 2. Measured value 測定結果

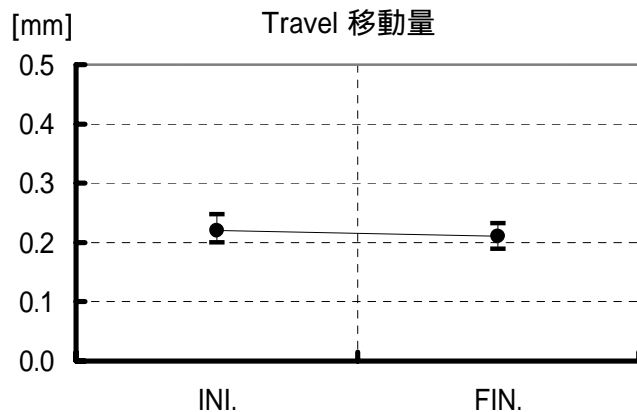
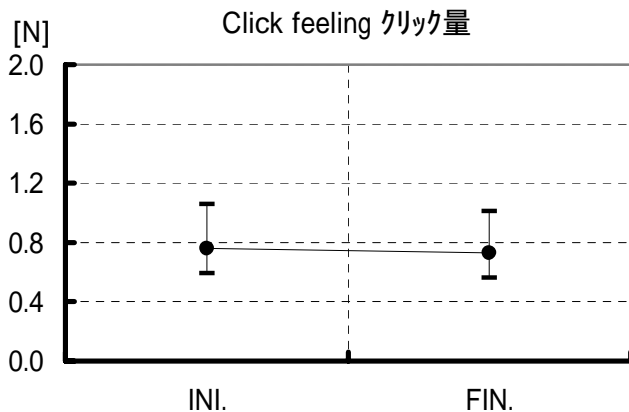
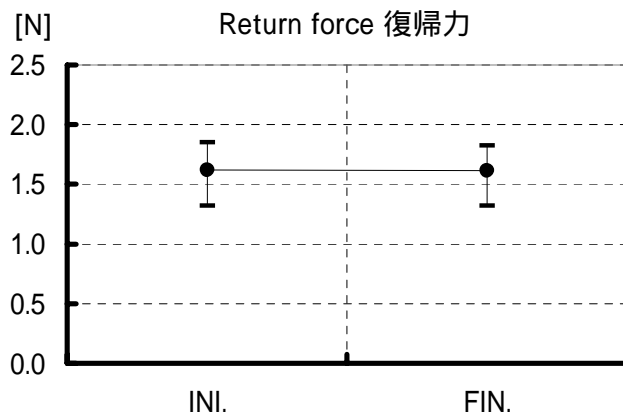
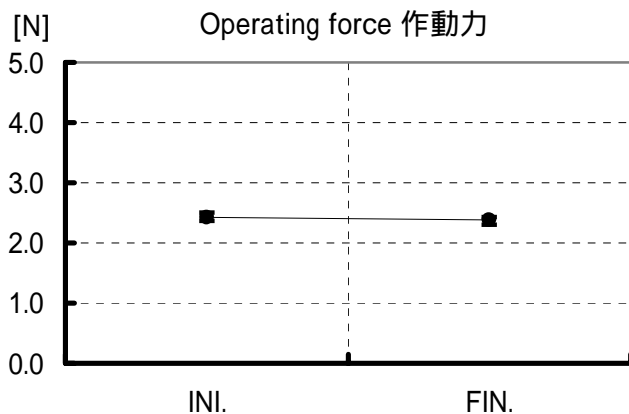
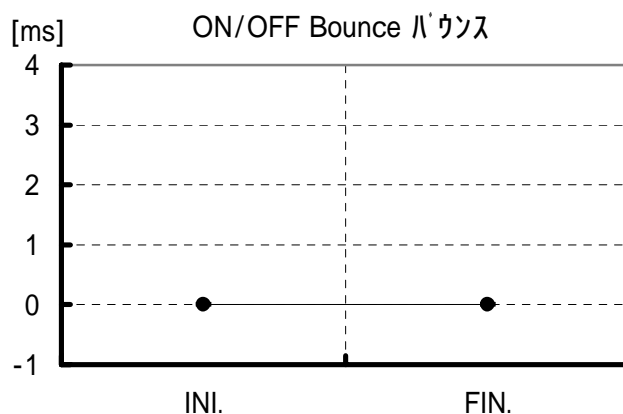
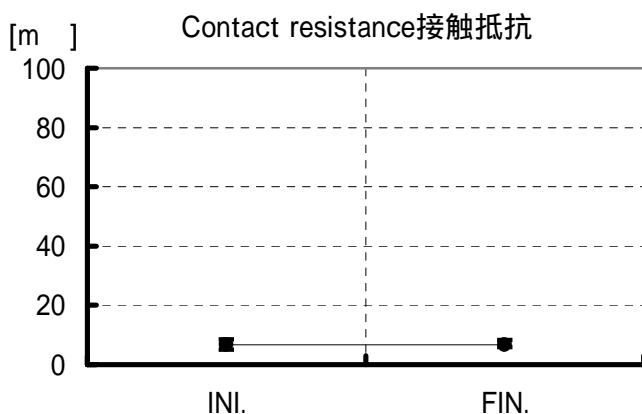

## Shock 耐衝撃性

### 1. Test conditions and criteria 試験条件及び判定基準

Number of samples: 20

Test conditions 試験条件	Criteria 判定条件
(1)Acceleration 衝撃加速度:784m/s <sup>2</sup>	Contact resistance 接触抵抗: 100m MAX
(2)Test direction 試験方向: 6面	Bounce(ON/OFF) バウンス: 10 ms MAX
(3)Number of shocks 試験回数: 3 times per direction (18 times in total) 各方向各3回(計18回)	Operating force 作動力: 2.35 ± 0.69 N
	Return force 復帰力: 0.49 N MIN
	Travel 移動量: 0.25+0.2/-0.1 mm

### 2. Measured value 測定結果

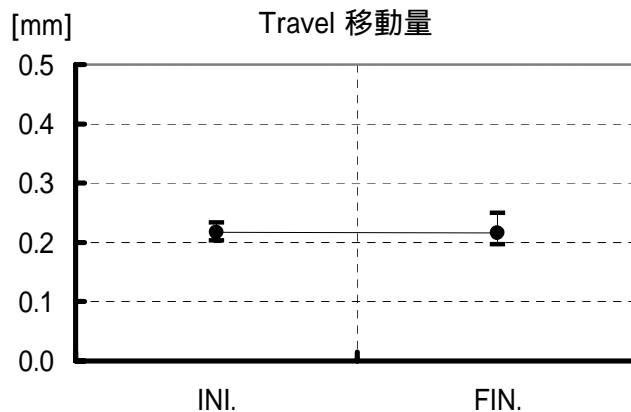
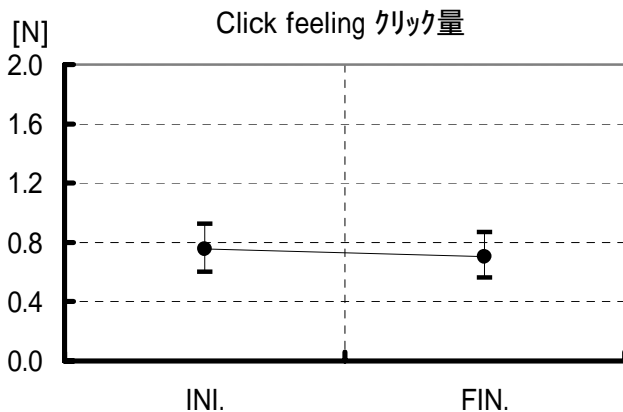
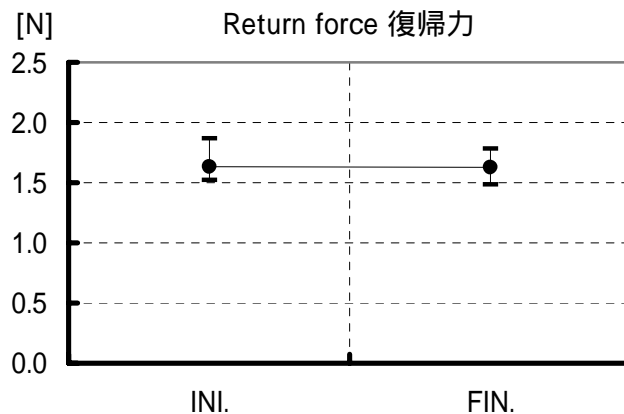
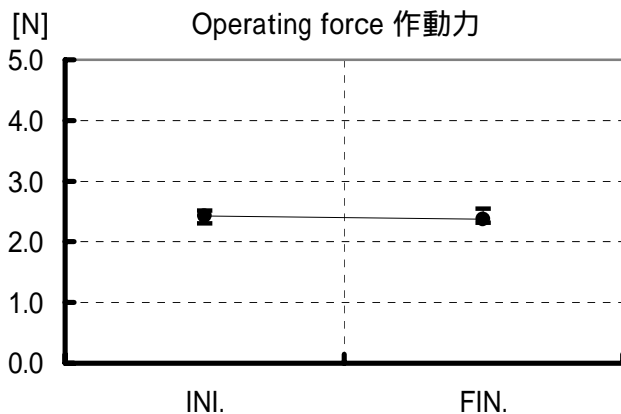
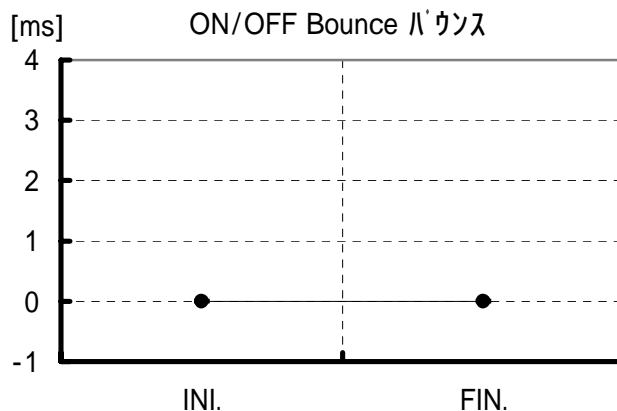
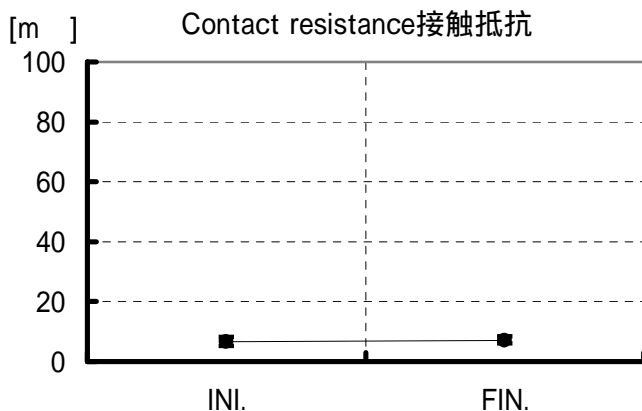

## Stop strength ストップ - 強度

### 1. Test conditions and criteria 試験条件及び判定基準

Number of samples: 20

Test conditions 試験条件	Criteria 判定条件
Depression 押圧力: 29.4 N Time 時間: 60 s	Contact resistance 接触抵抗: 100m MAX Bounce(ON/OFF) ハウンス: 10 ms MAX Operating force 作動力: 2.35 ± 0.69 N Return force 復帰力: 0.49 N MIN Travel 移動量: 0.25+0.2/-0.1 mm

### 2. Measured value 測定結果

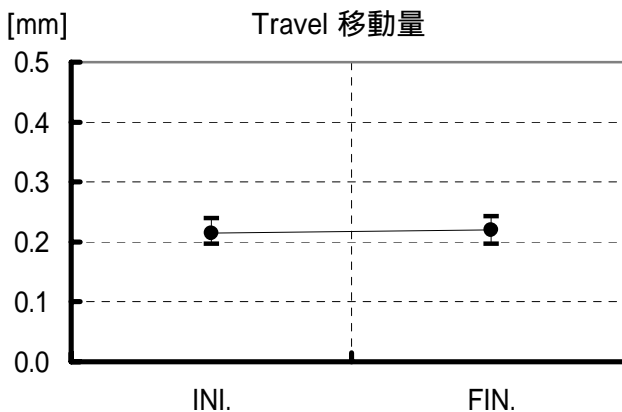
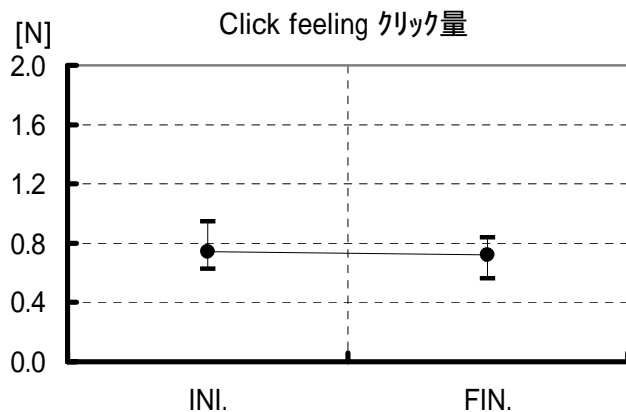
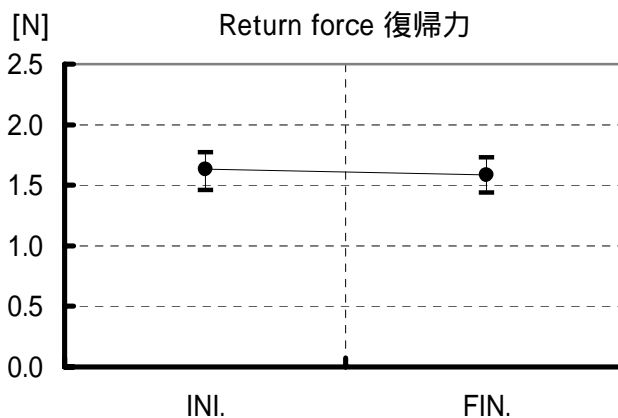
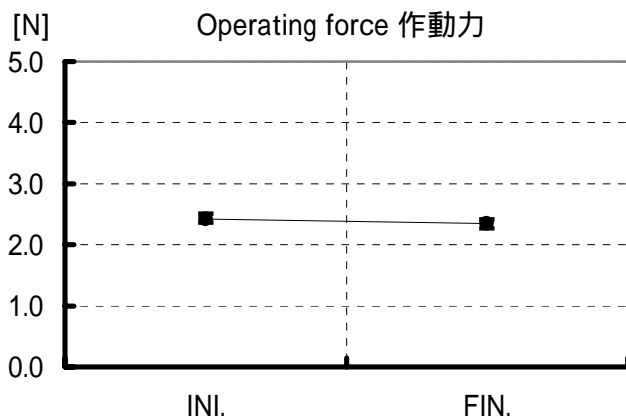
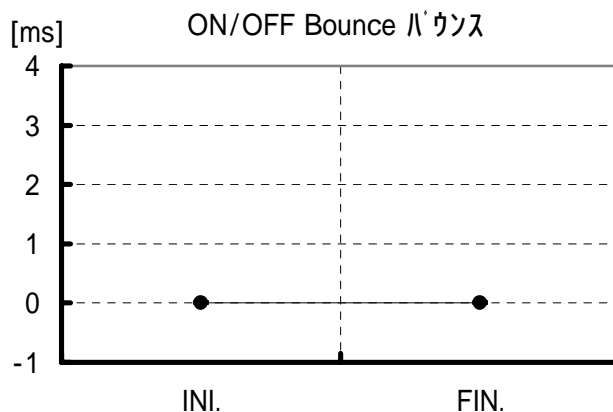
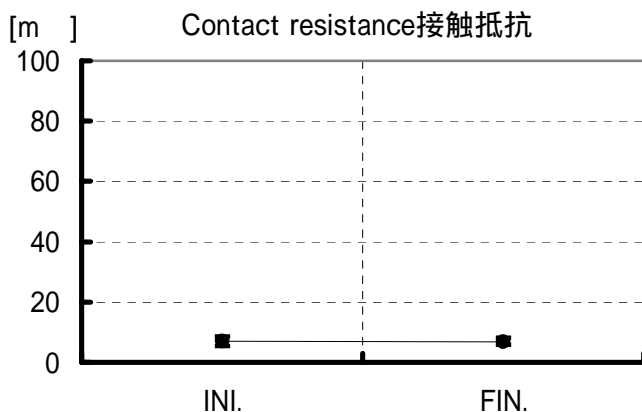

## Stem strength ステム拔去強度

### 1. Test conditions and criteria 試験条件及び判定基準

Number of samples: 20

Test conditions 試験条件	Criteria 判定条件	Judgement 判定
Placing the switch such that the direction of switch operation is vertical and then the maximum force to withstand a pull applied opposite to the direction of stem operation shall be measured. スイッチの操作方向が垂直になる様にスイッチを設置し、操作部の操作方向とは反対方向に操作部を引っ張って抜けない力である。	29.4 N	OK

## Hand soldering 手はんだ

### 1. Test conditions and criteria 試験条件及び判定基準

Number of samples: 20

Test conditions 試験条件	Criteria 判定条件
(1)Temperature 温度: 350 MAX (2)Time 時間: 3s MAX (3)Capacity of soldering iron はんだコ容量:60W MAX	Contact resistance 接触抵抗: 100m MAX Bounce(ON/OFF) バウンス: 10 ms MAX Operating force 作動力: 2.35 ± 0.69 N Return force 復帰力: 0.49 N MIN Travel 移動量: 0.25+0.2/-0.1 mm

### 2. Measured value 測定結果

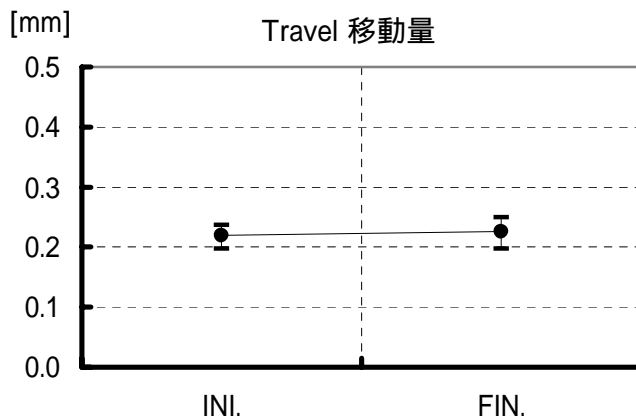
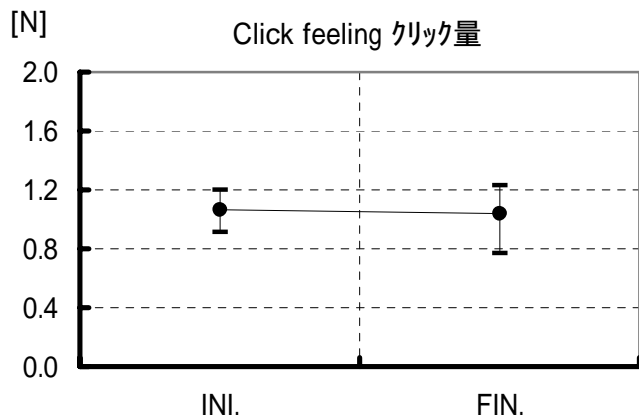
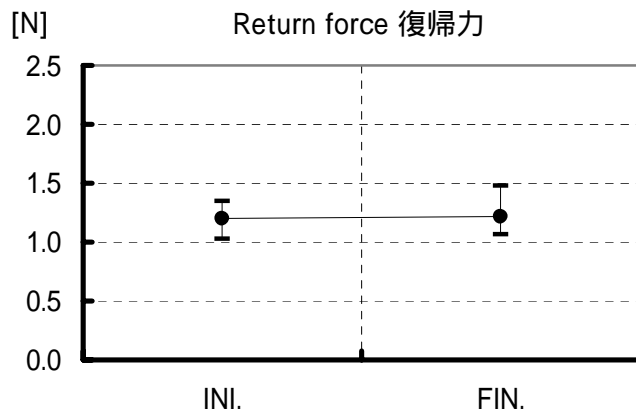
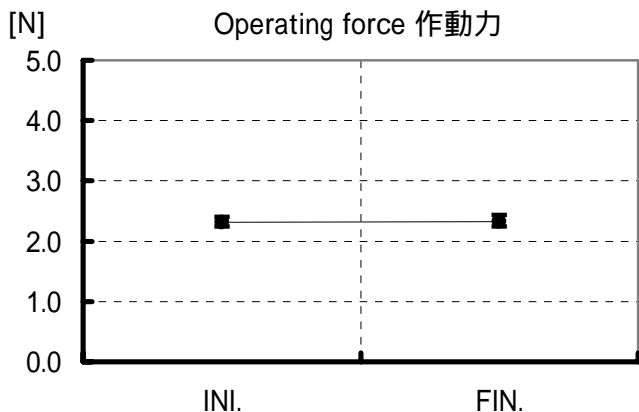
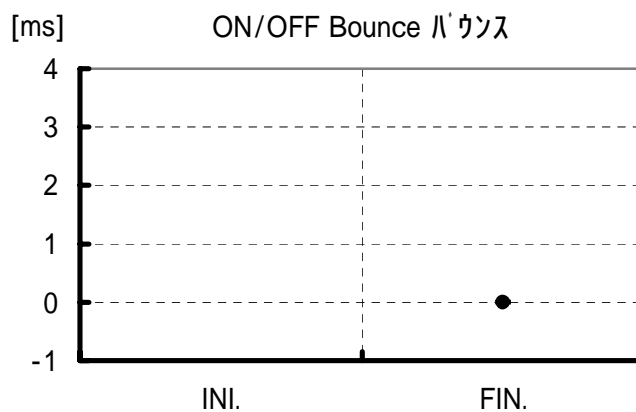
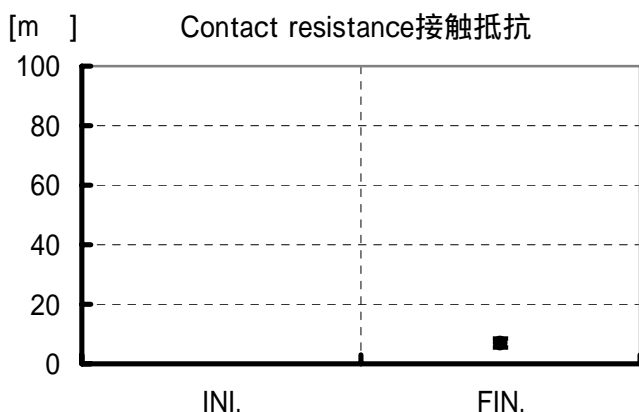

## Reflow soldering リフローはんだ

### 1. Test conditions and criteria 試験条件及び判定基準

Number of samples: 20

Test conditions 試験条件	Criteria 判定条件
Reflow - condition Preheat: 150 ~ 180 2min 260 3s 	Contact resistance 接触抵抗: 100m MAX Bounce(ON/OFF) ハウンス: 10 ms MAX Operating force 作動力: 2.35 ± 0.69 N Return force 復帰力: 0.49 N MIN Travel 移動量: 0.25+0.2/-0.1 mm

### 2. Measured value 測定結果

