

Rubber Metal Buffers

25150.0228



Product Description

To be used for elastic bearing of motors, compressors, pumps etc.
The hardness is $55 \pm 5^\circ$ shore A. Further shore hardnesses ($40 \pm 5^\circ$ shore A and $70 \pm 5^\circ$ shore A) on request.

Material

Support washer

- Steel, zinc-plated, blue chromated

Threaded bushing

- Steel, zinc-plated, blue chromated

Body

- Rubber natural caoutchouc (NR), black

Screw

- Steel, zinc-plated, blue chromated

Drawing

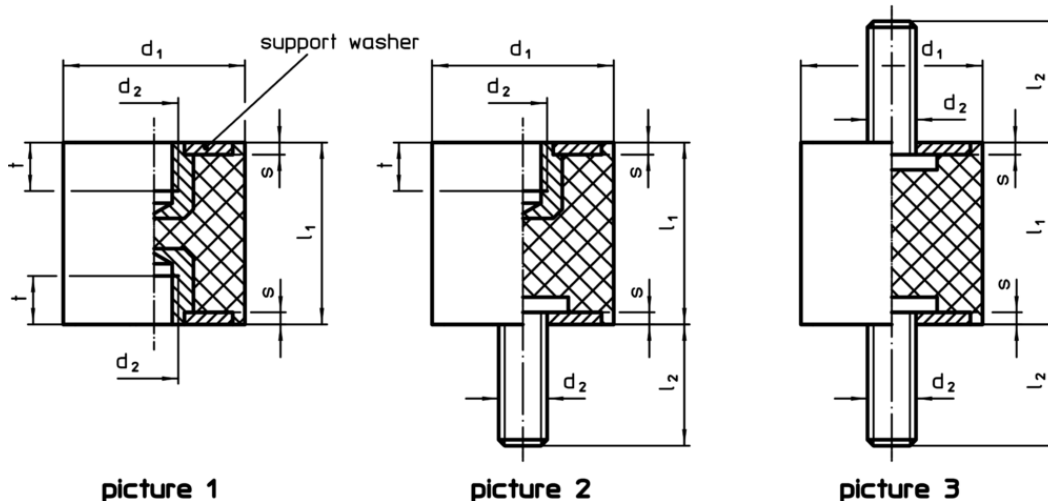

picture 1

picture 2

picture 3

Order information

Dimensions					Spring rate R	Load capacity max.	Spring range	Temperature range		Weight	Art. No.
d_1	l_1	d_2	l_2	s	~		~	min.	max.	[g]	
± 1.5	± 1.5				[N/mm]	[N]	[mm]	[°C]			
with screw, on both sides – picture 3											
25	30	M6	18	2	75	562	7.5	-30	80	39	25150.0228

Application example

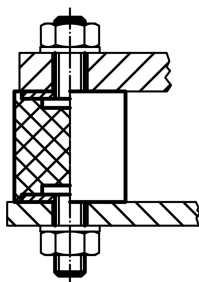

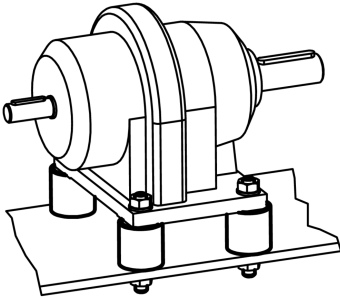

Compliance

RoHS compliant

Contains lead - compliant according to exceptions 6a / 6b / 6c

Contains SVHC substances >0,1% w/w

Contains lead - SVHC list [REACH] as of 10.06.2022

Contains Proposition 65 substances



Lead can cause cancer and reproductive harm from exposure
<https://www.P65Warnings.ca.gov/>

Free from Conflict Minerals

This product does not contain any substances designated as "conflict minerals" such as tantalum, tin, gold or tungsten from the Democratic Republic of Congo or adjacent countries.