

HA12009

7-Segment Decoder/Driver for Digital Tuning System

The HITACHI HA12009 has been developed as 7-Segment Decoder and Driver for Digital Tuning System. Its features are as follows.

■ FEATURES

- Capable of displaying all the indication for the MW/FM
- Tuner for Japan and U.S.A. (Except channel indication).
- For Europe, additional frequency band display required.
- Clock Display also
- Low Noise due to the Static Display
- LED and Fluorescent Display Tube can be operated
- Capable of operating the circuit with five input signals (BCD signals & Timing signal)
- Larger programmable range of micro processor due to the internal latch function

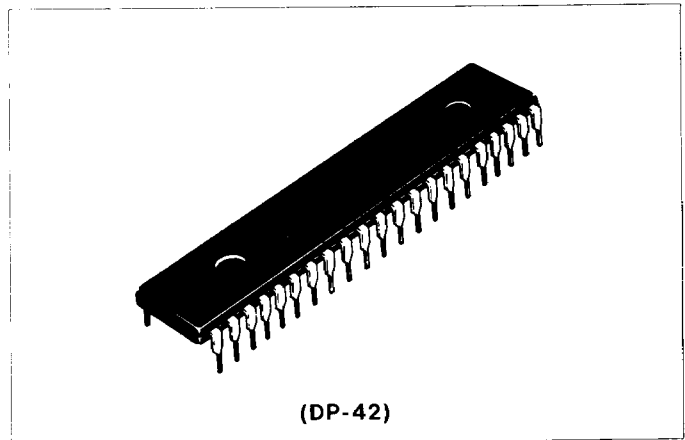

■ ABSOLUTE MAXIMUM RATINGS ($T_a=25^\circ\text{C}$)

Item	Symbol	Rating	Unit
Supply Voltage	V_{CC}	15	V
Input Voltage (pins 16~20)	$V_{I\ max}$	7	V
Output Current	pin 22	22	mA
	Others	11	mA
Power Dissipation	P_T	750	mW
Operating Temperature	T_{opr}	-30 to +75	$^\circ\text{C}$
Storage Temperature	T_{stg}	-55 to +125	$^\circ\text{C}$

■ PIN FUNCTIONS

No.	Function	No.	Function	No.	Function
1	f_1 of 10th digit	15	SW Decimal Point (Europe) MW (Japan, U.S.A.)	29	d_3 of 10^3 digit
2	g_1 of 10th digit	16	Data M_0	30	e_2 of 10^2 digit
3	g_0 of unit digit	17	Data M_1	31	d_2 of 10^2 digit
4	f_0 of unit digit	18	Data M_2	32	f_2 of 10^2 digit
5	e_0 of unit digit	19	Data M_3	33	g_2 of 10^2 digit
6	d_0 of unit digit	20	Timing	34	a_2 of 10^2 digit
7	b_0 of unit digit	21	GND	35	b_2 of 10^2 digit
8	c_0 of unit digit	22	b_3, c_3 of 10^4 digit (Europe)/ FM (Japan)	36	c_2 of 10^2 digit
9	a_0 of unit digit	23	d_3 of 10^3 digit	37	V_{CC}
10	Colon	24	f_3 of 10^3 digit (Europe)/ Alarm (U.S.A., Japan)	38	b_1 of 10th digit
11	PM	25	c_3 of 10^3 digit	39	c_1 of 10th digit
12	kHz	26	a_3 of 10^3 digit	40	a_1 of 10th digit
13	MHz	27	g_3 of 10^3 digit	41	d_1 of 10th digit
14	FM Decimal Point	28	e_3 of 10^3 digit	42	e_1 of 10th digit



■ BLOCK DIAGRAM

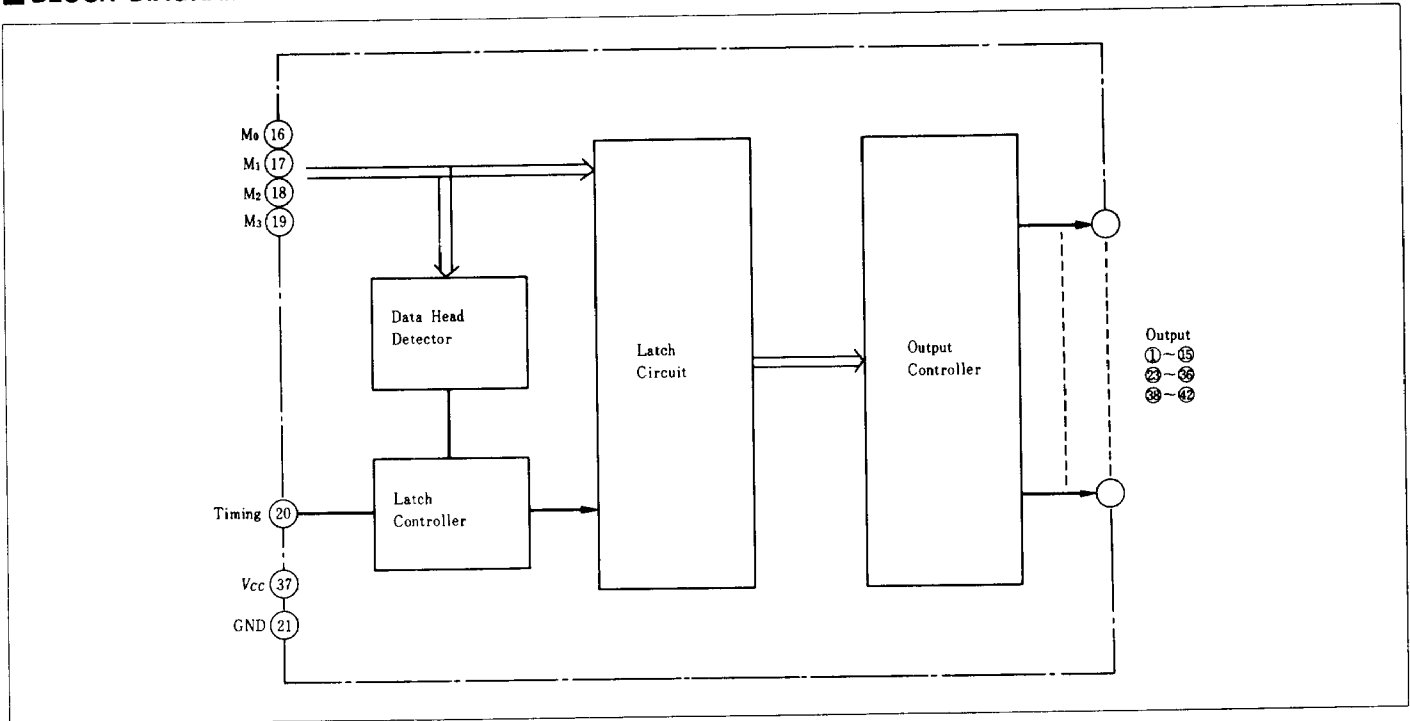

■ ELECTRICAL CHARACTERISTICS (Unless otherwise specified, $T_a=25^\circ\text{C}$, $V_{CC}=8\text{V}$)

Item	Symbol	Test Conditions	min.	typ.	max.	Unit
Operating Supply Voltage (1)	V_{CC} (1)	Under LED displaying	7.2	8.0	8.8	V
Operating Supply Voltage (2)	V_{CC} (2)	Under fluorescent display tube displaying	12.0	13.0	14.0	V
High Level Input Voltage	V_{IH}	Pins 16~20	2.4	—	7.0	V
Low Level Input Voltage	V_{IL}	Pins 16~20	0	—	0.6	V
High Level Output Drivability (1)*	I_{OH} (1)	Pin 22	22	—	—	mA
High Level Output Drivability (2)*	I_{OH} (2)	Pins 1~15, 23~36, 38~42	11	—	—	mA
Low Level Output Current (1)	I_{OL} (1)	Pin 22	—	—	20	μA
Low Level Output Current (2)	I_{OL} (2)	Pins 1~15, 23~36, 38~42	—	—	10	μA
High Level Output Voltage (1)	V_{OH} (1)	Pin 22, $I_{OH} = -20\text{mA}$	—	7.0	—	V
High Level Output Voltage (2)	V_{OH} (2)	Pins 1~15, 23~36, 38~42, $I_{OH} = -10\text{mA}$	—	7.0	—	V
Low Level Input Current	I_{IL}	Pins 16~20, $V_{in} = 0.4\text{V}$	-0.6	—	—	mA
Supply Current (1)	I_{CC} (1)	With all the displays off $V_{CC}=8\text{V}$	—	27.4	—	mA
Supply Current (2)	I_{CC} (2)	With all the displays off $V_{CC}=13\text{V}$	—	31.0	—	mA

Note: * Output current drivabilities are prescribed in these items.
 The Output current should be within the range of maximum ratings, when used.

FUNCTIONAL EXPLANATION

1. Structure of Input Signals

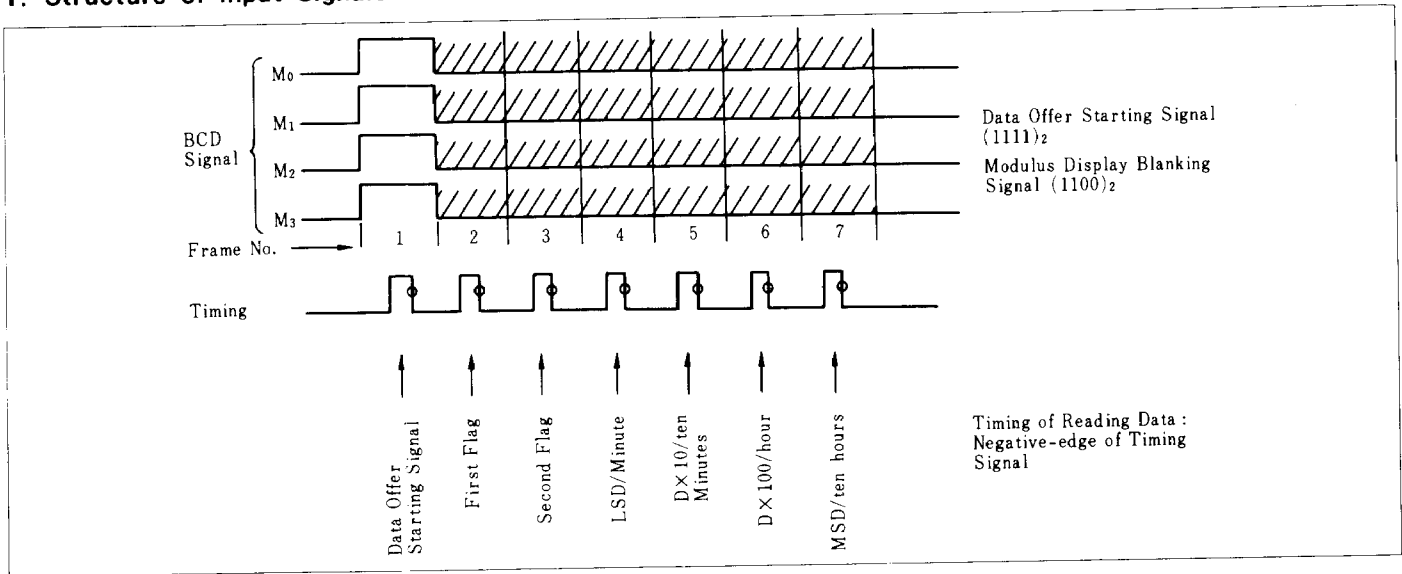

2. Timing of Input Signal

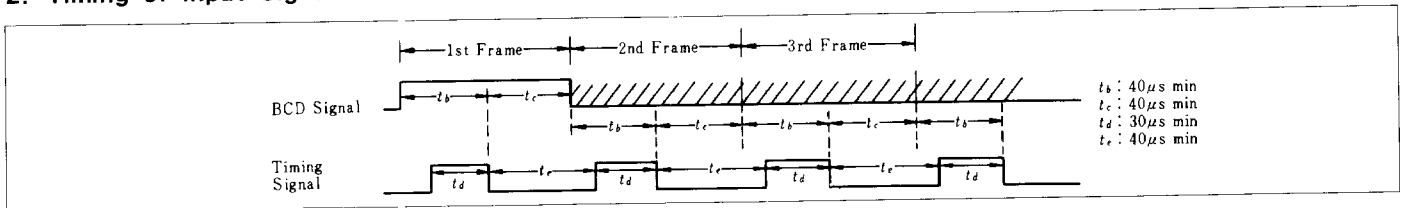

3. Conditions of BCD Signal Cording

* Frame No.	Data Offer Mode	M3 (2 ³ Digit)	BCD M2 (2 ² Digit)	Signal M1 (2 ¹ Digit)	M0 (2 ⁰ Digit)	Reference	
1	Starting	1	1	1	1		
2	1st Flag	Clock Display With Radio On	0	0	(Display Mode) in Japan & U.S.A. 1 / 0 in Europe	(2nd Flag Information) Frequency 1 / 0 Real or Alarm Time	Display OFF Signal : (1100) ₂
		Clock Display With Radio Off	0	1			(1101) ₂
		Frequency Display With Radio On	1	0			(1110) ₂
		With Display Off	1	1			Inhibit Signal : (1111) ₂
3	Freq.	FM	1	0	(Alarm) Set 1 / 0 Reset	0	
		MW	0	1			
		SW	1	1			
		LW	0	0			
	Real Time	(Sec. Flash) ON 1 / 0 OFF	PM 1 / 0 AM	(Alarm) Set 1 / 0 Reset	0		
Alarm Time	1	PM 1 /	(Alarm) Set 1 / 0 Reset	0			
4	Frequency : LSD, Time : Minute Digit	1/0	1/0	1/0	1/0	Blanking Signal : (1100) ₂ Inhibit Signal : (1010) ₂ (1011) ₂ (1101) ₂ (1110) ₂ (1111) ₂ Signals 0~9 : Corresponding to BCD Signals M0~M3	
5	Frequency : D×10 Time : Ten Minutes Digit	1/0	1/0	1/0	1/0		
6	Frequency : D×100, Time : Hour	1/0	1/0	1/0	1/0		
7	Frequency : MSD, Time : Ten Hours	1/0	1/0	1/0	1/0		

* Frame No.

DISPLAY CHARACTERS

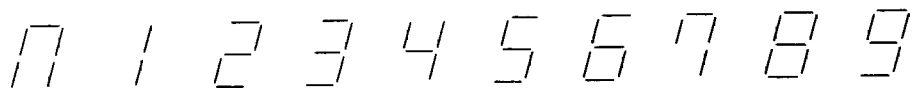

4. DISPLAY

○ : Complete Display ▲ : External Display
 △ : Partial Display - : Display Unnecessary

Display Item	Applicable Area (BCD from Microcomputer Switches)		
	Japan/USA	Europe	
Real Time	Time	○ 12/24 Hours	○ 12/24 Hours
	Colon	○ Tuning ON and OFF	○ Tuning ON and OFF
	AM/PM	△ Only PM Displayed (12 Hours Display)	△ Only PM Displayed (12 Hours Display)
Alarm Time	Time	○ 12/24 Hours	○ 12/24 Hours
	Colon	○ ON	○ ON
	AM/PM	△ Only PM Displayed (12 Hours Display)	△ Only PM Displayed (12 Hours Display)
	Alarm Set	○	▲ Drive at the External Circuit by the Signal from Microcomputer
Received Signal	Frequency	○	○
	"FM"	○	▲
	"MW"	○	▲
	"LW"	-	▲
	"SW"	-	▲
	"MHz"	○	○
	"kHz"	○	○
	Decimal Point SW	○	○
The Others	Display OFF	○	○
	Dimmer	▲ External Control	▲ External Control

■ TEST CIRCUIT

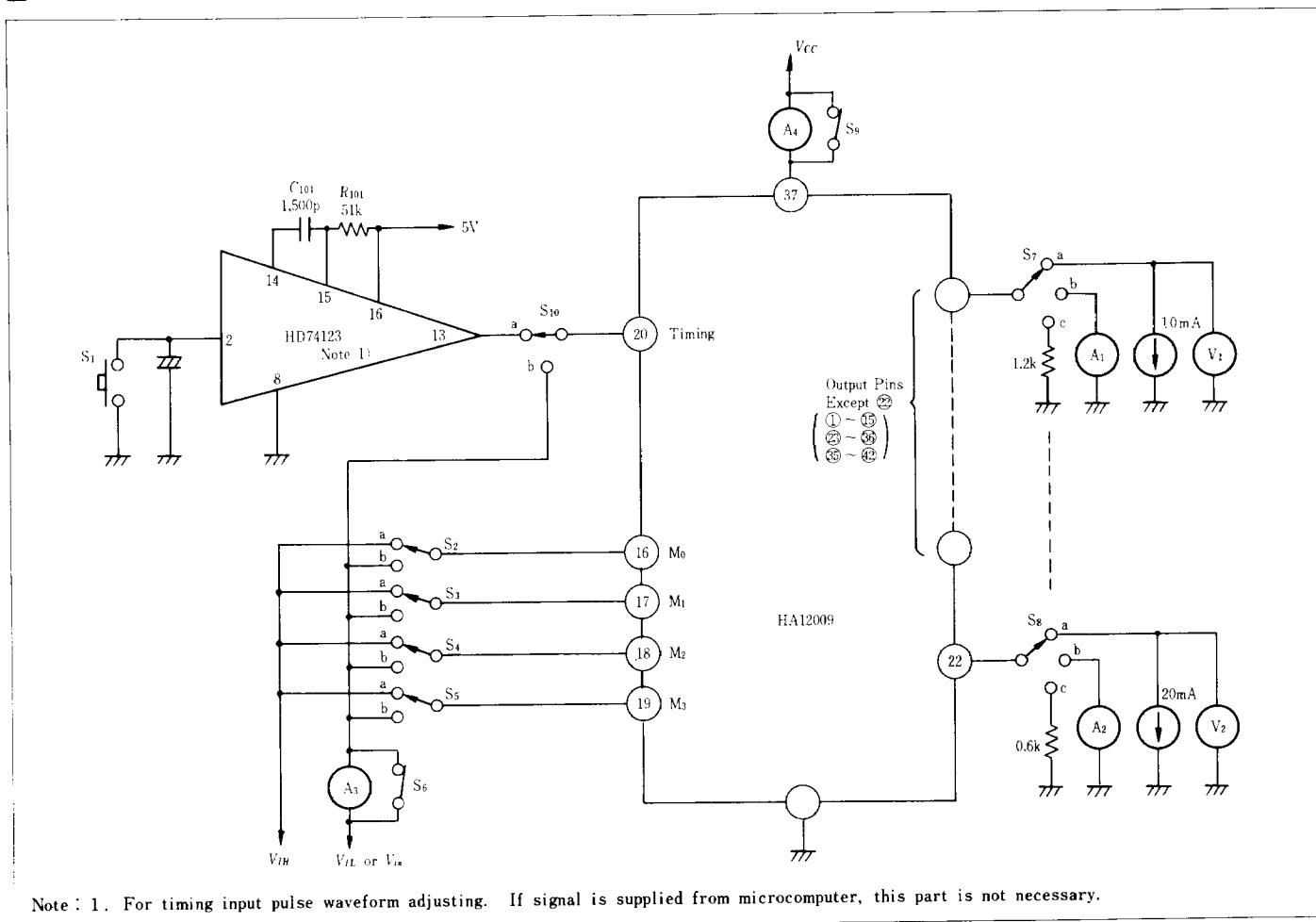

INPUT CURRENT VS. SUPPLY VOLTAGE

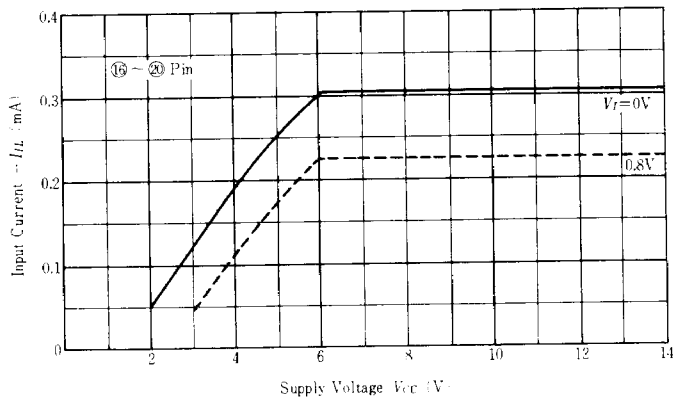

INPUT CURRENT VS. INPUT VOLTAGE

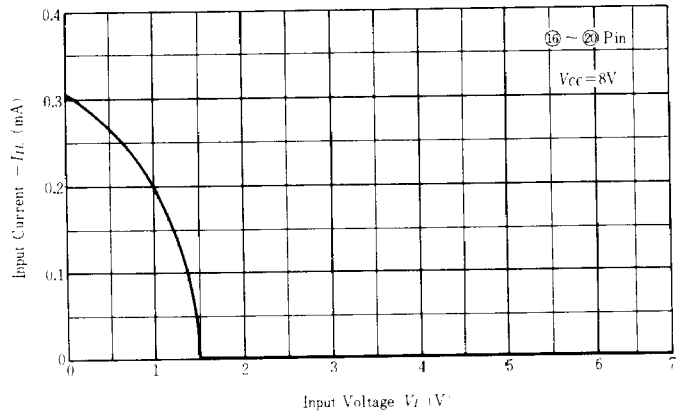

INPUT CURRENT VS. AMBIENT TEMPERATURE

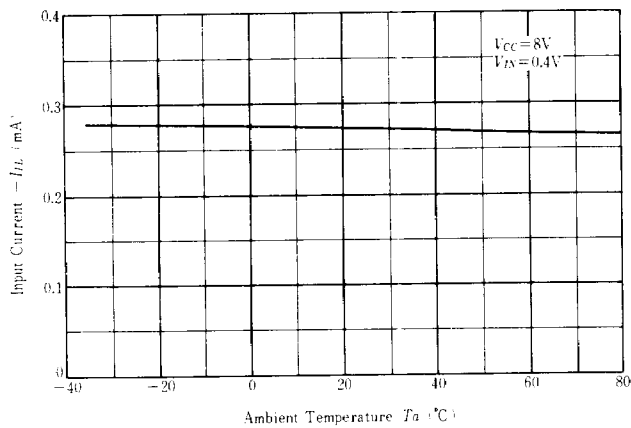

$(V_{CC} - V_{OH})$ VS. OUTPUT CURRENT

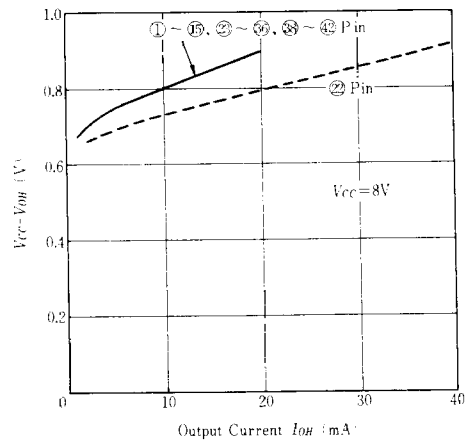

$(V_{CC} - V_{OH})$ VS. AMBIENT TEMPERATURE

