

AC Filter, hohe symmetrische Dämpfung

new



### Beschreibung

- Chassis:  
Schraubbefestigung, von oben
- Netzfilter in Standard-Version, 1-stufig, hohe Dämpfung
- Hohe symmetrische Einfügungsdämpfung im Frequenzbereich von 10kHz bis 30 MHz

### Zulassungen

- VDE Ausweisnummer: 40041643
- UL Ausweisnummer: E72928

### Merkmale

- Kompaktes Filter mit hoher symmetrischer Dämpfung
- Ausgelegt für universelle Industrie-Anwendungen
- Speziell für Anwendungen mit hohen symmetrischen Störungen verursacht durch schaltende Halbleiter
- Geeignet für den Einsatz in Geräten nach IEC/UL 60950
- Geeignet für den Einsatz in Medizinalgeräten nach IEC/UL 60601-1

### Weitere Ausführungen auf Anfrage

- Version mit Litzenanschlüssen

### Weblinks

[pdf-Datenblatt](#), [html-Datenblatt](#), [Allgemeine Produktinformationen](#), [Zulassungen](#), [CE-Konformitätserklärung](#), [RoHS](#), [CHINA-RoHS](#), [REACH](#), [e-Shop](#), [SCHURTER-Stock-Check](#), [Distributor-Stock-Check](#), [Detailanfrage zu Typ](#)

### Technische Daten

Nennstrom IEC	1 - 30A @ Tu 40 °C / 250VAC; 50Hz
Nennstrom UL/CSA	1 - 30A @ Tu 40 °C / 125/250VAC; 60Hz
Ableitstrom	industriell < 1 mA (250V / 60Hz)
Spannungsfestigkeit	> 1.7 kVDC zwischen L-N > 2.7 kVDC zwischen L/N-PE Prüfspannung (2 sec)
Zulässige Betriebstemp.	-25 °C bis 100 °C
Klimakategorie	25/100/21 gemäss IEC 60068-1
Schutzklasse	Geeignet für Geräte der Schutzklasse I nach IEC 61140
Anschluss	Steckanschluss 6.3 x 0.8 mm Schraubanschluss M4
Material: Gehäuse	Metall

Netzfilter	Standard-, Medizinal- und Industriever- sion, IEC 60939, UL 1283, CSA C22.2 no. 8 <a href="#">Technische Details</a>
MTBF	> 200'000h nach MIL-HB-217 F

## Abmessung

Gehäuse PG mit Steckanschlüssen

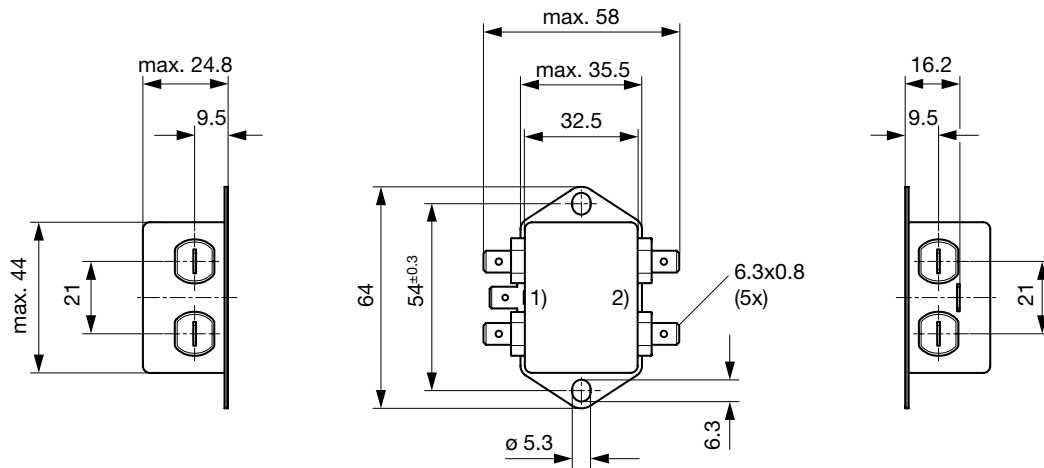

1) Netz

2) Last

Gehäuse PH mit Steckanschlüssen

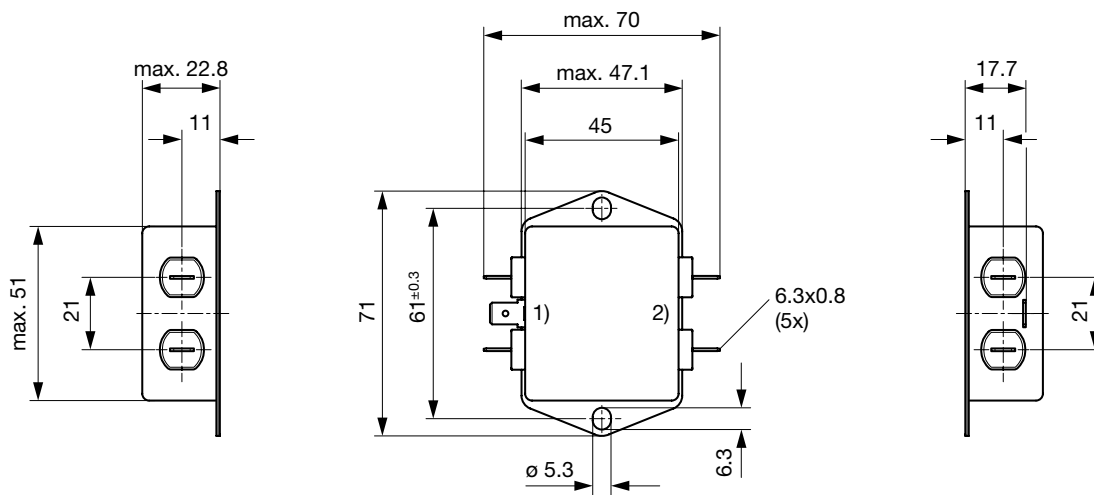

1) Netz

2) Last

Gehäuse PI mit Steckanschlüssen

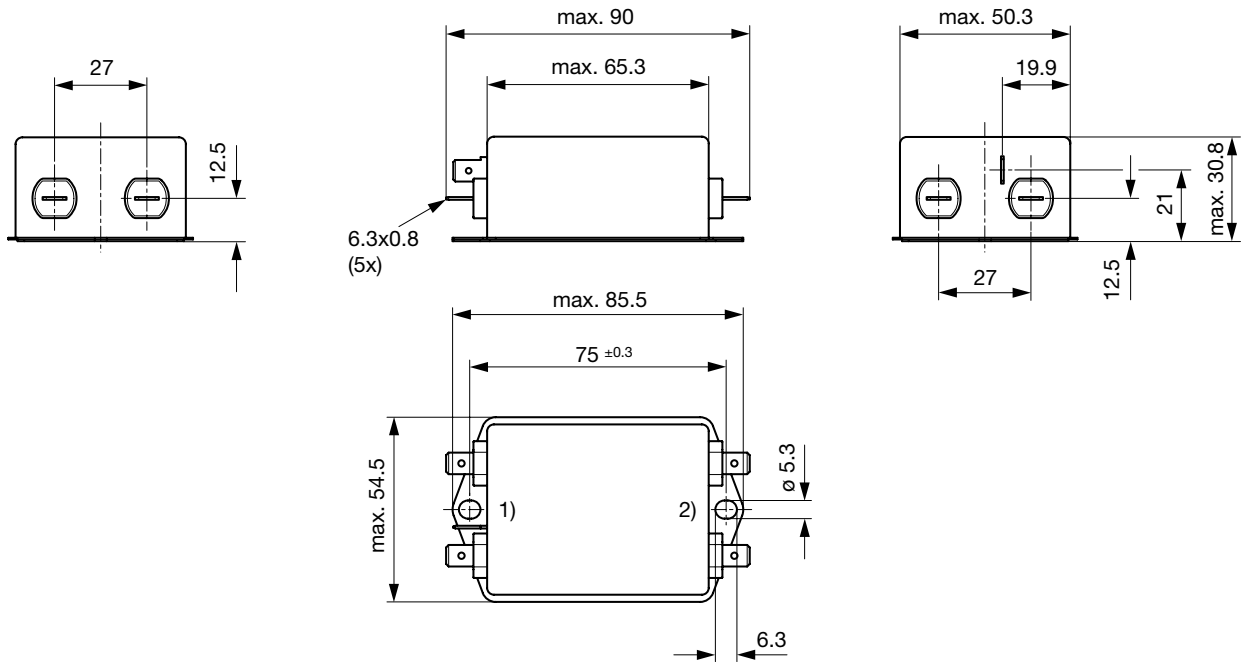

- 1) Netz
- 2) Last

Gehäuse PK mit Steckanschlüssen

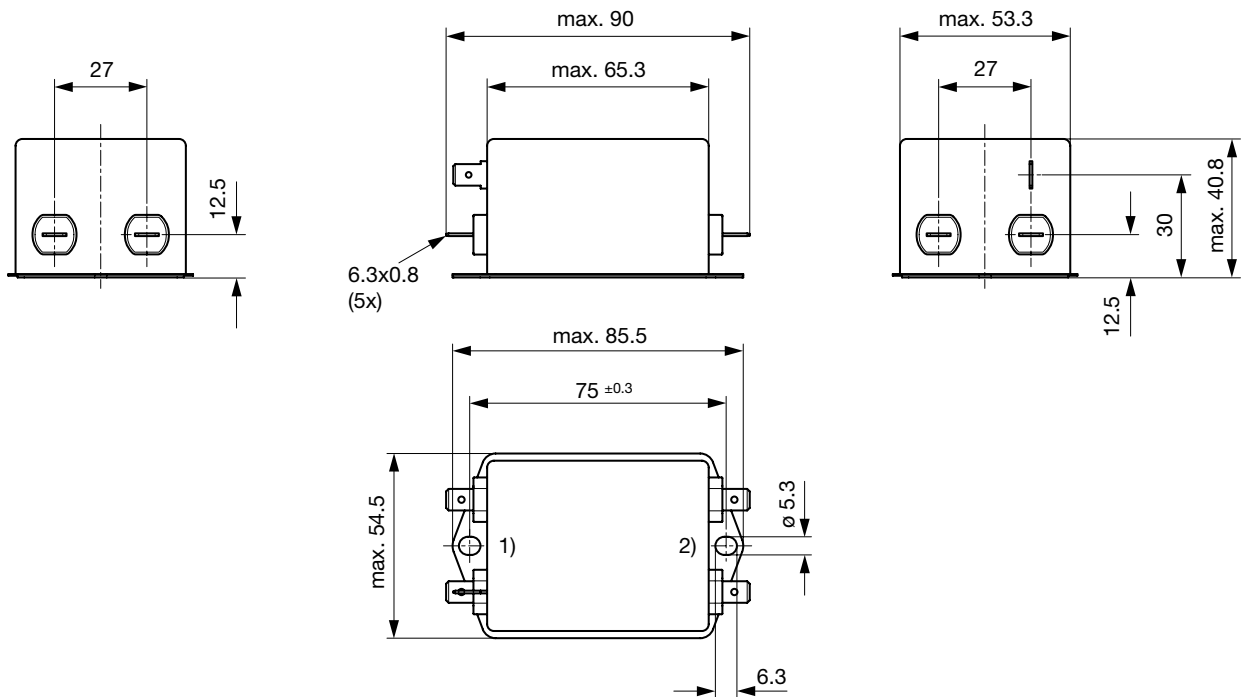

- 1) Netz
- 2) Last

## Gehäuse PK mit Schraubanschlüssen

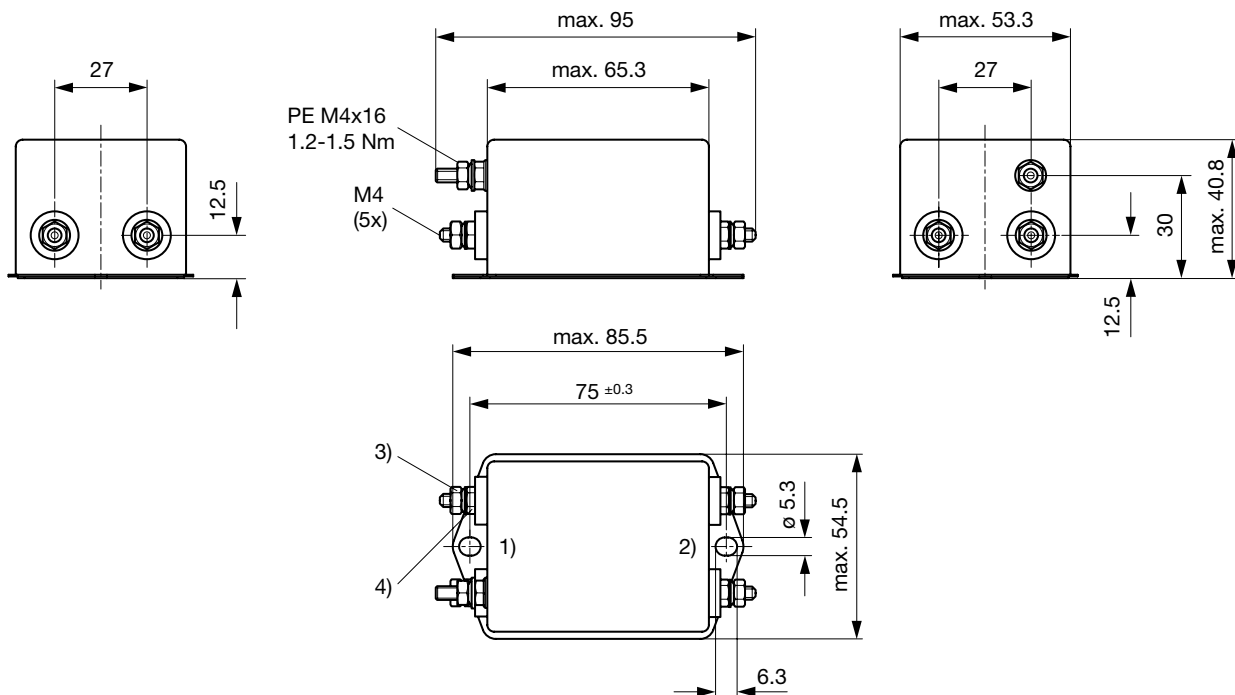

- 1) Netz
- 2) Last
- 3) Anziehdrehmoment 0.8...1 Nm, Kontermutter festhalten
- 4) Kontermutter nicht lösen

## Schaltbilder

Standard Version

Medizinal Version M5

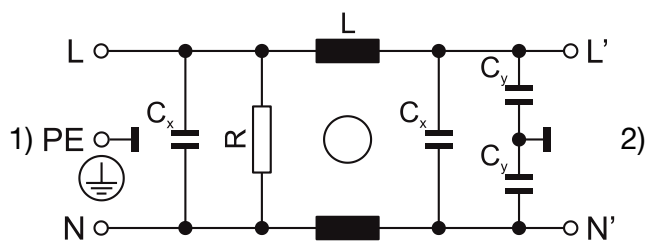

- 1) Netz
- 2) Last

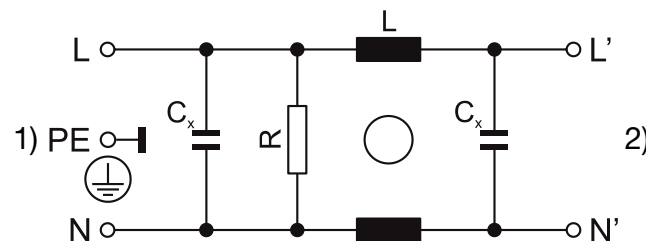

- 1) Netz
- 2) Last

**Einfügungsdämpfungen**

..... 0.1/100Ω symmetrisch ..... 100/0.1Ω symmetrisch - - - symmetrisch \_\_\_\_ asymmetrisch

Standard Version

1 A

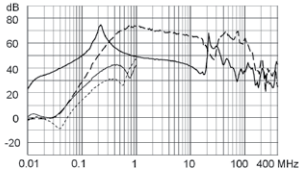

3 A

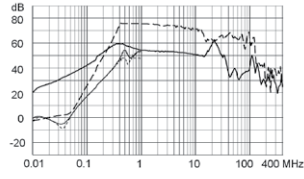

4 A

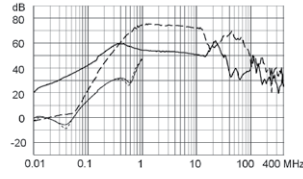

6 A

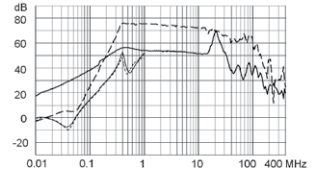

8 A

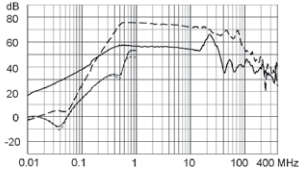

10 A

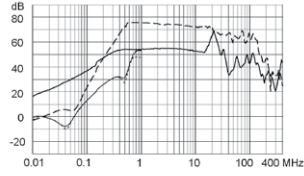

12 A

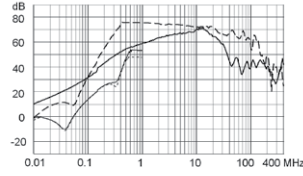

16 A

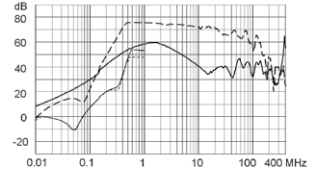

20 A

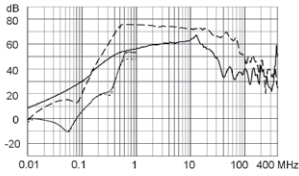

30 A

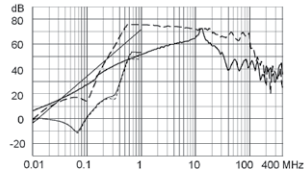

Medizinal Version (M5)

1 A

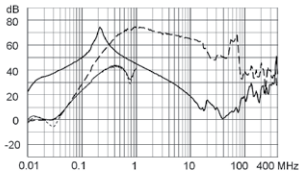

3 A

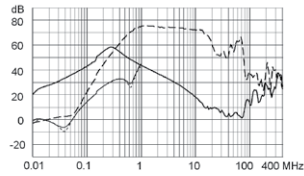

4 A

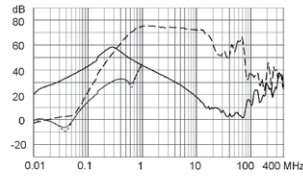

6 A

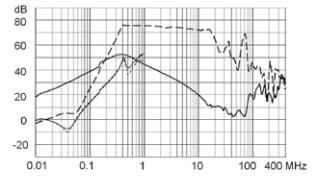

8 A

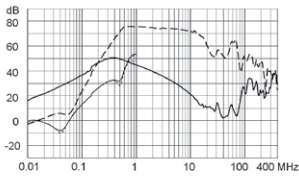

10 A

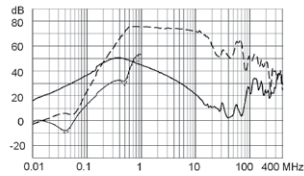

12 A

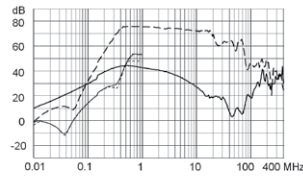

16 A

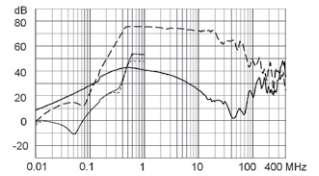

20 A

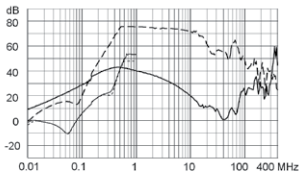

30 A

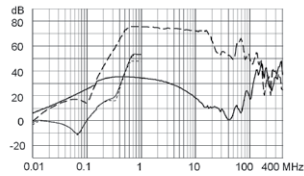

## Alle Varianten

Nennstrom	Filter-Typ	Anschluss	Design	Ableitstrom	Ri	Verlustleistung	Gewicht	Gehäuse	Verpackung	Bestell-Nummer
[A]				[mA]	[mΩ]	[W]	[g]		[ST]	
1	Standard Version	Steckanschluss 6.3 x 0.8 mm	N	0.5	475	1	72 g	PG	15	5500.2630.01
3	Standard Version	Steckanschluss 6.3 x 0.8 mm	N	0.5	83	1.5	104 g	PH	15	5500.2631.01
4	Standard Version	Steckanschluss 6.3 x 0.8 mm	N	0.5	53	1.7	108 g	PH	15	5500.2632.01
6	Standard Version	Steckanschluss 6.3 x 0.8 mm	N	0.5	32.5	2.4	109 g	PH	15	5500.2633.01
8	Standard Version	Steckanschluss 6.3 x 0.8 mm	N	0.5	29.2	3.8	190 g	PI	10	5500.2634.01
10	Industrie Version	Steckanschluss 6.3 x 0.8 mm	N	1	22.8	4.6	200 g	PI	10	5500.2635.01
12	Industrie Version	Steckanschluss 6.3 x 0.8 mm	N	1	13.2	3.8	201 g	PI	10	5500.2636.01
16	Industrie Version	Steckanschluss 6.3 x 0.8 mm	N	1	7.2	3.7	308 g	PK	10	5500.2637.01
20	Industrie Version	Steckanschluss 6.3 x 0.8 mm	N	1	6.0	4.8	322 g	PK	10	5500.2638.01
30	Industrie Version	Schraubanschluss M4	N	1	2.9	5.2	355 g	PK	10	5500.2639.03
1	Medizinal (M5)	Steckanschluss 6.3 x 0.8 mm	N	0.005	475	1	72 g	PG	15	5500.2630.04

Sie können die Verfügbarkeit all unserer Produkte in Echtzeit prüfen: <http://www.schurter.com/de/Stock-Check/Produktverfuegbarkeit-SCHURTER>