

1 2 3 4 5 6

A

B

C

D

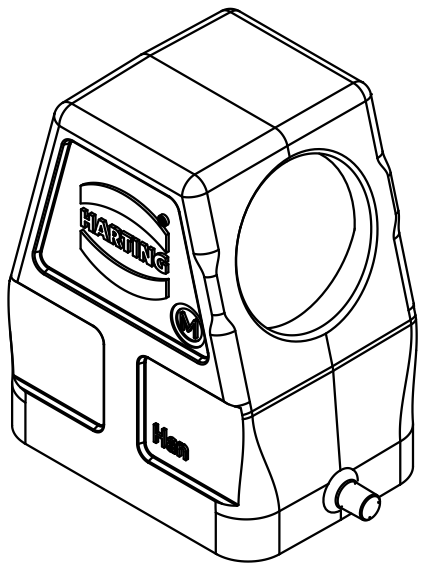
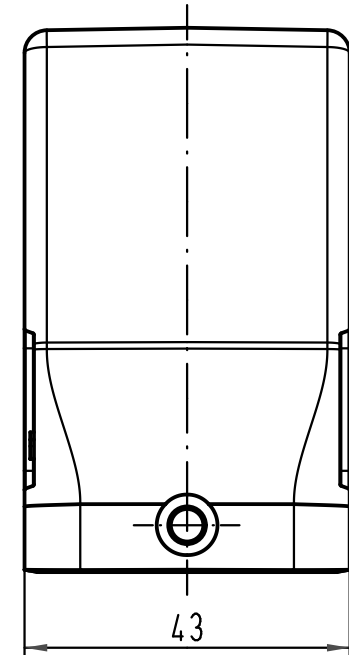
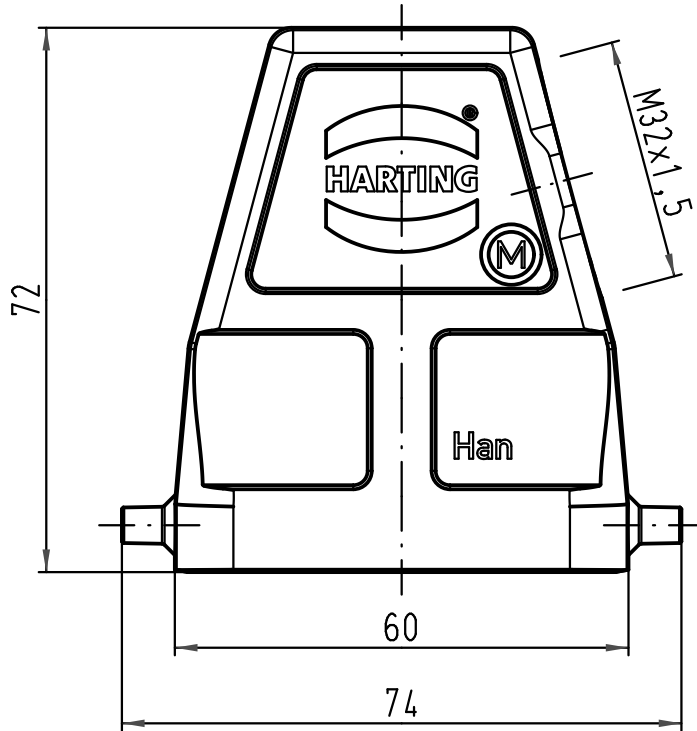

All Dimensions in mm Original Size DIN A 4		Techn. Character.			Nicht tolerierte Maße/ Free size tolerances	
			Dat.	Name	Maßstab/ Scale  1:1	Han 6B-gs-M32 Gehäuse hood
		Detail.	19.02.09	ML		
		Insp.		Sch		
		Stand.				
B	09.02.11	Spr	HARTING Electric GmbH & Co. KG			TB 19 30 006 0547
A			D-32339 Espelkamp			
Mod.	Dat.	Name				Sub. TB 19 30 006 0547 v. 15.11.00
						Blatt/ page