

Operating Instructions

RNO22

1- or 2-channel output isolating amplifier 24 V DC,
HART-transparent



Table of contents

1	About this document	3	11	Repair	17
1.1	Document function	3	11.1	General information	17
1.2	Symbols	3	11.2	Spare parts	18
1.3	Registered trademarks	4	11.3	Return	18
			11.4	Disposal	18
2	Basic safety instructions	5	12	Technical data	19
2.1	Requirements for the personnel	5	12.1	Function and system design	19
2.2	Designated use	5	12.2	Input	19
2.3	Workplace safety	5	12.3	Output	20
2.4	Operational safety	5	12.4	Power supply	21
2.5	Product safety	6	12.5	Performance characteristics	22
2.6	Installation instructions	6	12.6	Installation	22
3	Product descriptions	7	12.7	Environment	23
3.1	Product description RNO22	7	12.8	Mechanical construction	25
4	Incoming acceptance and product identification	7	12.9	Display and operating elements	26
4.1	Incoming acceptance	7	12.10	Ordering information	26
4.2	Product identification	8	12.11	Accessories	27
4.3	Scope of delivery	9	12.12	Certificates and approvals	27
4.4	Certificates and approvals	9	12.13	Supplementary documentation	28
4.5	Storage and transport	9	13	Appendix: system overview of RN Series	29
5	Installation	9	13.1	Power supply of RN Series	29
5.1	Installation conditions	9	13.2	Applications of the RN Series devices	35
5.2	Installing the DIN rail bus connector	10	Index	42	
5.3	Installing a DIN rail device	10			
5.4	Disassembling the DIN rail device	11			
6	Electrical connection	12			
6.1	Connection conditions	12			
6.2	Quick wiring guide	13			
6.3	Connecting the supply voltage	13			
6.4	Post-connection check	13			
7	Operation options	15			
7.1	Display and operating elements	15			
8	Commissioning	15			
8.1	Post-installation check	15			
8.2	Switching on the device	16			
9	Diagnostics and troubleshooting ...	17			
9.1	General troubleshooting	17			
10	Maintenance	17			





1 About this document

1.1 Document function













These Operating Instructions contain all the information that is required in various phases of the life cycle of the device: from product identification, incoming acceptance and storage, to mounting, connection, operation and commissioning through to troubleshooting, maintenance and disposal.

1.2 Symbols





1.2.1 Safety symbols

 DANGER This symbol alerts you to a dangerous situation. Failure to avoid this situation will result in serious or fatal injury.	 WARNING This symbol alerts you to a dangerous situation. Failure to avoid this situation can result in serious or fatal injury.
 CAUTION This symbol alerts you to a dangerous situation. Failure to avoid this situation can result in minor or medium injury.	 NOTICE This symbol contains information on procedures and other facts which do not result in personal injury.

1.2.2 Symbols for certain types of information

Symbol	Meaning
	Permitted Procedures, processes or actions that are permitted.
	Preferred Procedures, processes or actions that are preferred.
	Forbidden Procedures, processes or actions that are forbidden.
	Tip Indicates additional information.
	Reference to documentation
	Reference to page
	Reference to graphic
	Notice or individual step to be observed
	Series of steps
	Result of a step
	Help in the event of a problem
	Visual inspection

1.2.3 Electrical symbols

	Direct current		Alternating current
	Direct current and alternating current		Ground connection A grounded terminal which, as far as the operator is concerned, is grounded via a grounding system.

1.2.4 Symbols in graphics

1, 2, 3,...	Item numbers	A, B, C, ...	Views
-------------	--------------	--------------	-------

1.2.5 Symbols at the device

	Warning Observe the safety instructions contained in the associated Operating Instructions
---	--

1.3 Registered trademarks

HART®

Registered trademark of the FieldComm Group, Austin, Texas, USA

2 Basic safety instructions

2.1 Requirements for the personnel

The personnel for installation, commissioning, diagnostics and maintenance must fulfill the following requirements:

- ▶ Trained, qualified specialists must have a relevant qualification for this specific function and task.
- ▶ Are authorized by the plant owner/operator.
- ▶ Are familiar with federal/national regulations.
- ▶ Before starting work, read and understand the instructions in the manual and supplementary documentation as well as the certificates (depending on the application).
- ▶ Follow instructions and comply with basic conditions.

The operating personnel must fulfill the following requirements:

- ▶ Are instructed and authorized according to the requirements of the task by the facility's owner-operator.
- ▶ Follow the instructions in this manual.

2.2 Designated use

2.2.1 Output isolating amplifier

The output isolating amplifier is used to control I/P transducers, control valves and display units. The device separates and transmits 0/4 to 20 mA signals. For operating the SMART actuators, the analog measuring value can be overlaid with digital communication signals (HART) and transmitted bidirectionally in an electrically isolated manner. The device enables open-circuit and short-circuit monitoring. An intrinsically safe version is optionally available for operation in Zone 2. The device is designed for installation on DIN rails in accordance with IEC 60715.

2.2.2 Product liability

The manufacturer does not accept any responsibility for damage that results from non-designated use and from failure to comply with the instructions in this manual.

2.3 Workplace safety

For work on and with the device:

- ▶ Wear the required personal protective equipment according to federal/national regulations.

2.4 Operational safety

Risk of injury!

- ▶ Operate the device only if it is in proper technical condition, free from errors and faults.
- ▶ The operator is responsible for interference-free operation of the device.

Modifications to the device

Unauthorized modifications to the device are not permitted and can lead to unforeseeable dangers:

- ▶ If modifications are nevertheless required, consult with the manufacturer.

Repair

To ensure continued operational safety and reliability:

- ▶ Carry out repairs on the device only if they are expressly permitted.
- ▶ Observe federal/national regulations pertaining to the repair of an electrical device.
- ▶ Use only original spare parts and accessories from the manufacturer.

Hazardous area

To eliminate danger to persons or the facility when the device is used in the hazardous area (e.g. explosion protection):

- ▶ Check the nameplate to verify if the device ordered can be put to its intended use in the hazardous area.
- ▶ Observe the specifications in the separate supplementary documentation that is an integral part of these instructions.

2.5 Product safety

This device is designed in accordance with good engineering practice to meet state-of-the-art safety requirements, has been tested, and left the factory in a condition in which it is safe to operate.

2.6 Installation instructions

- The device's IP20 degree of protection is intended for a clean and dry environment.
- Do not expose the device to mechanical and/or thermal stress that exceeds the specified limits.
- The device is intended for installation in a cabinet or similar housing. The device may only be operated as an installed device.
The cabinet must meet the fire protection housing requirements according to safety standard UL/IEC 61010-1 and provide adequate protection against electric shock or burns.
- To protect against mechanical or electrical damage, the device must be installed in an appropriate housing with a suitable degree of protection according to IEC/EN 60529.
- During installation, repair and maintenance work, the device must be disconnected from all effective power sources if the power sources are not SELV or PELV circuits.
- Only use copper cables as the connection cable.
- A SELV/PELV power unit with a nominal voltage of 24 V_{DC} (max. 30 V_{DC}) is required for the external device power supply.

3 Product descriptions

3.1 Product description RNO22

3.1.1 Product design

Output isolating amplifier, 1-channel

- With the "1-channel" option, the output isolating amplifier is used to control I/P converters, control valves and indicators. The device separates and transmits 0/4 to 20 mA signals. For operating the SMART actuators, the analog measuring value can be overlaid with digital communication signals (HART) and transmitted bidirectionally in an electrically isolated manner.
- Sockets for the connection of HART communicators are integrated in the plug-in connectors. The device enables open-circuit and short-circuit monitoring. Short-circuit monitoring can be switched off or on using the DIP switches. An open or shorted field circuit causes a high input impedance on the controller side. This enables open-circuit and short-circuit monitoring by the control system. A green LED indicates that the device is ready for operation.
- The device is optionally available with Ex approvals for the intrinsically safe operation of I/P converters, control valves and indicators installed in the hazardous area. Separate Ex documentation (XA) is supplied with these devices. Compliance with the installation instructions and connection data in this documentation is mandatory!

Output isolating amplifier, 2-channel

With the "2-channel" option, the device has a second channel, which is galvanically isolated from channel 1, while maintaining the same width. In the 2-channel version, short-circuit monitoring **cannot** be switched off or on using the DIP switches. Otherwise, the function corresponds to the 1-channel device.

4 Incoming acceptance and product identification

4.1 Incoming acceptance

Check the following during incoming acceptance:

- Are the order codes on the delivery note and the product sticker identical?
- Are the goods undamaged?
- Do the nameplate data match the ordering information on the delivery note?



If one of these conditions is not met, please contact the manufacturer's sales office.

4.2 Product identification

The following options are available for identification of the device:

- Nameplate specifications
- Extended order code with breakdown of the device features on the delivery note
- Enter the serial number from the nameplate in the *W@M Device Viewer* (www.endress.com/deviceviewer): all data relating to the device and an overview of the Technical Documentation supplied with the device are displayed.
- Enter the serial number on the nameplate into the *Endress+Hauser Operations App* or scan the 2-D matrix code (QR code) on the nameplate with the *Endress+Hauser Operations App*: all the information about the device and the technical documentation pertaining to the device is displayed.

4.2.1 Nameplate

The right device?

Compare and check the data on the nameplate of the device against the requirements of the measuring point:

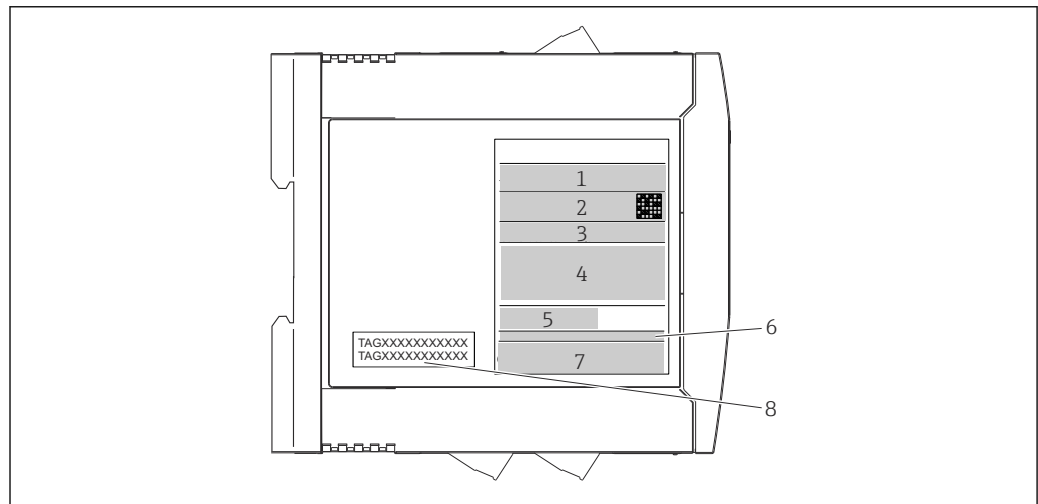

A0041996

 1 Nameplate (example of Ex version)

- 1 Product name and manufacturer ID
- 2 Order code, extended order code and serial number, DataMatrix 2D code, FCC-ID (if applicable)
- 3 Power supply and current consumption, output
- 4 Approval in hazardous area with number of the relevant Ex documentation (XA...)
- 5 Fieldbus communication logo
- 6 Firmware version and device revision
- 7 Approval logos
- 8 2 lines for the TAG name

4.2.2 Name and address of manufacturer

Name of manufacturer:	Endress+Hauser Wetzler GmbH + Co. KG
Address of manufacturer:	Obere Wank 1, D-87484 Nesselwang
Model/type reference:	RNO22

4.3 Scope of delivery

The scope of delivery comprises:

- Device as per order
- Printed copy of the Brief Operating Instructions
- Optional: Functional safety manual (SIL mode)
- Additional documentation for devices which are suitable for use in the hazardous area (Ex, I, II, III), such as Safety Instructions (XA...), Control or Installation Drawings (ZD...).

4.4 Certificates and approvals

 For certificates and approvals valid for the device: see the data on the nameplate

 Approval-related data and documents: www.endress.com/deviceviewer → (enter the serial number)

4.4.1 Functional safety

A SIL version of the device is optionally available. It can be used in safety equipment in accordance with IEC 61508 up to SIL 2 (SC 3).

 Please refer to Safety Manual FY01037K for the use of the device in safety instrumented systems according to IEC 61508.

Protection against modifications:

As it is not possible to disengage the operating elements (keys and DIP switches), a lockable control cabinet is required for use in SIL applications. The cabinet must be locked by key. A normal electrical cabinet key does not suffice for this purpose.

4.5 Storage and transport

 When storing and transporting the device, pack it so that it is reliably protected against impact. The original packaging provides optimum protection.

5 Installation

5.1 Installation conditions

5.1.1 Dimensions

The dimensions of the device are provided in the 'Technical data' section of the Operating Instructions.

5.1.2 Mounting location

The device is designed for installation on 35 mm (1.38 in) DIN rails in accordance with IEC 60715 (TH35).

The device's housing provides basic insulation from neighboring devices for 300 Veff. If several devices are installed side by side, this must be taken into consideration and additional insulation must be provided if necessary. If the adjacent device also offers basic insulation, no additional insulation is required.

NOTICE

- ▶ When using in hazardous areas, the limit values of the certificates and approvals must be observed.

i For information on ambient conditions, see the "Technical data" section.

5.2 Installing the DIN rail bus connector

i If using the DIN rail bus connector for the power supply, clip it onto the DIN rail BEFORE mounting the device. Pay attention to the orientation of the module and DIN rail bus connector when doing so: the snap-on clip should be at the bottom and the connector piece on the left!

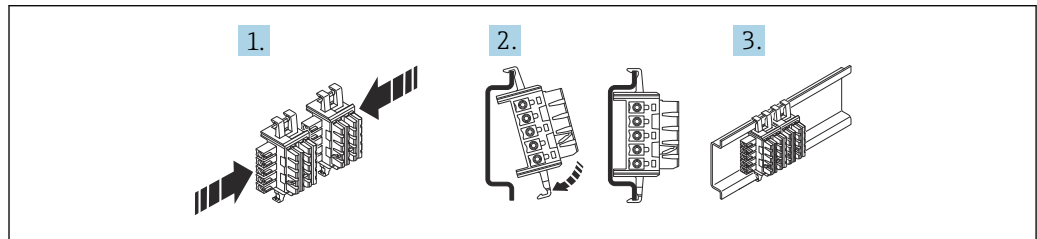

A0041738

2 Installing the DIN rail bus connector 12.5 mm (0.5 in)

1. Connect two or more DIN rail bus connectors together.
2. Attach the DIN rail bus connectors to the top of the DIN rail and allow them to click into place on the underside of the DIN rail.
3. The DIN rail devices can now be installed.

5.3 Installing a DIN rail device

The device can be installed in any position (horizontal or vertical) on the DIN rail without lateral clearance from neighboring devices. No tools are required for installation. The use of end brackets (type "WEW 35/1" or similar) on the DIN rail is recommended to fix the device.

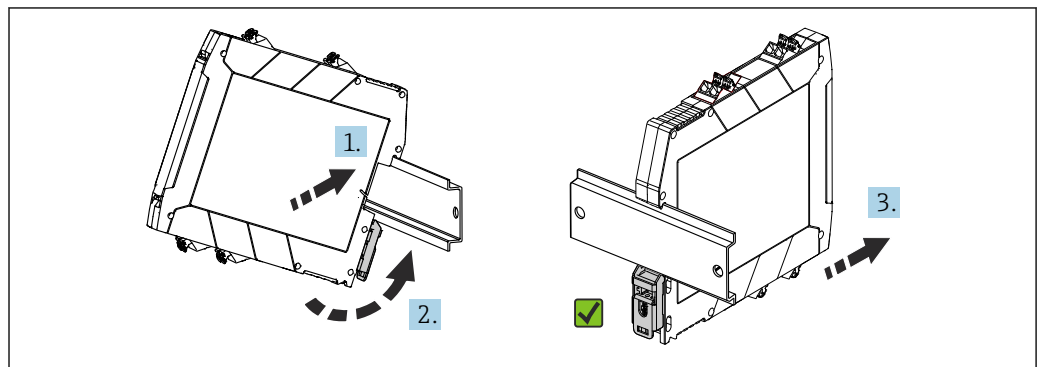

A0041736

3 Installing on DIN rail

1. Position the top DIN rail groove at the top end of the DIN rail.
2. While holding the front of the device horizontally, lower it until you hear the locking clip of the device click into place on the DIN rail.
3. Pull gently on the device to check if it is correctly mounted on the DIN rail.

5.4 Disassembling the DIN rail device

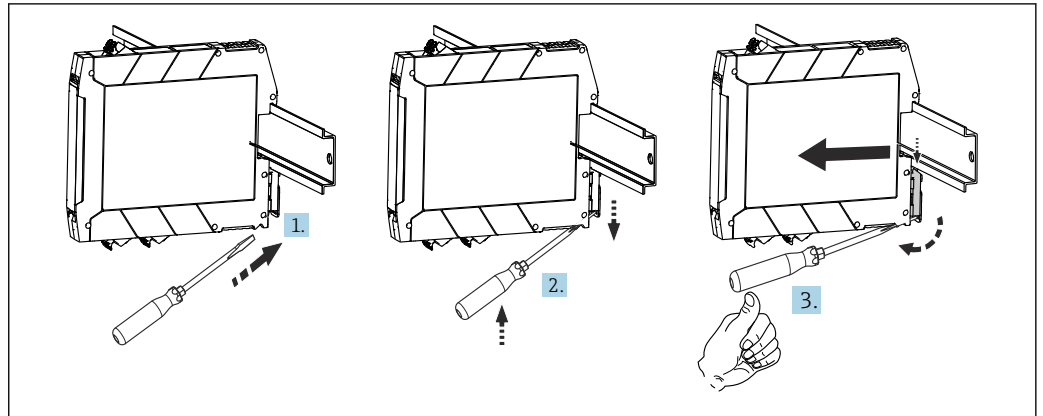

4 Disassembling the DIN rail device

A0039696

1. Insert a screwdriver into the tab of the DIN rail clip.
2. Use the screwdriver to pull down on the DIN rail clip as shown in the diagram.
3. Hold down the screwdriver to remove the device from the DIN rail.

6 Electrical connection

6.1 Connection conditions

A flat-blade screwdriver is required to establish an electrical connection to screw or push-in terminals.

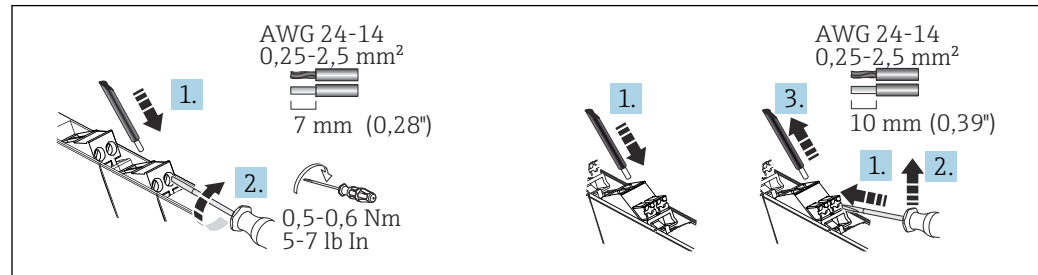

5 Electrical connection using screw terminals (left) and push-in terminals (right)

CAUTION

Destruction of parts of the electronics

- ▶ Switch off the power supply before installing or connecting the device.

NOTICE

Destruction or malfunction of parts of the electronics

- ▶  ESD - Electrostatic discharge. Protect the terminals from electrostatic discharge.

6.1.1 Special connection instructions

- Disconnecting units and auxiliary circuit protective systems with suitable AC or DC values must be provided in the building installation.
- A switch/power circuit breaker must be provided close to the device and clearly marked as a disconnecting unit for this device.
- An overcurrent protection unit ($I \leq 6 \text{ A}$) must be provided in the installation.
- The voltages applied at the input, output and power supply are all extra-low voltages (ELV). Depending on the application, an exposed dangerous voltage ($> 30 \text{ V}_{\text{AC}} / > 60 \text{ V}_{\text{DC}}$) to ground can be present at the device. Safe galvanic isolation between the input and output side is provided for this scenario.

 For information on the connection data, see the "Technical data" section.

6.2 Quick wiring guide

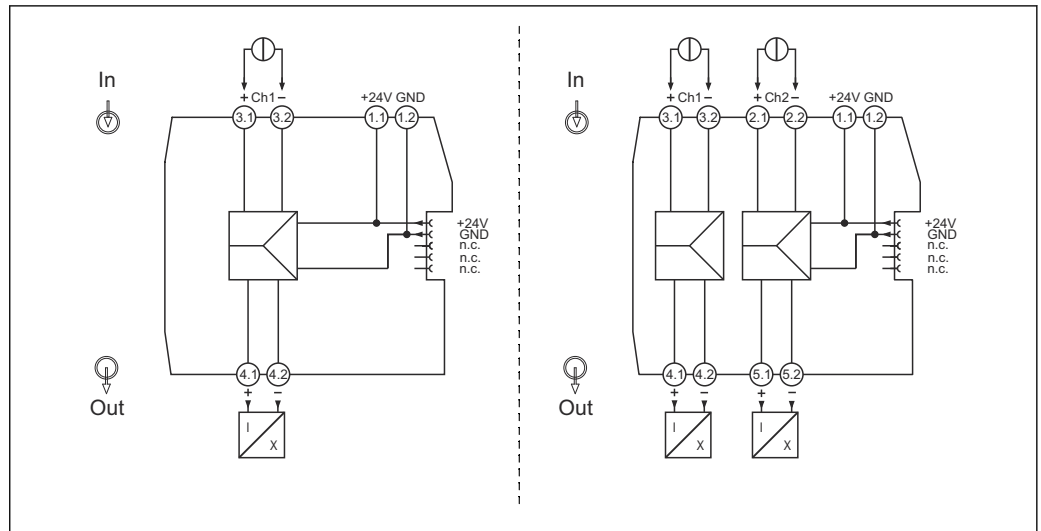

6 Terminal assignment of RNO22: 1-channel version (left), 2-channel version (right)

i Sockets for the connection of HART communicators are integrated in the plug-in connectors (screw connection). Ensure an adequate external resistance ($\geq 230 \Omega$) in the output circuit.

6.3 Connecting the supply voltage

Power can be supplied via terminals 1.1 and 1.2 or via the DIN rail bus connector.

6.3.1 Using the power and error message module to supply power

It is recommended to use the RNF22 power and error message module to provide the supply voltage to the DIN rail bus connector. An overall current of 3.75 A is possible with this option.

6.3.2 Supply to the DIN rail bus connector via terminals

Devices installed side by side can be powered via the terminals of the device up to a total current consumption of 400 mA. The connection is via the DIN rail bus connector. The installation of a 630 mA fuse (semi-delay or slow-blow) upstream is recommended.

NOTICE

The simultaneous use of terminals and DIN rail bus connectors to supply power is not permitted! The tapping of energy from the DIN rail bus connector for further distribution is not permitted.

► The supply voltage must never be connected directly to the DIN rail bus connector!

6.4 Post-connection check

Device condition and specifications	Notes
Are the device or cables free from damage (visual check)?	--
Do the ambient conditions match the device specification (e.g. ambient temperature, measuring range, etc.)?	See "Technical data"

Device condition and specifications	Notes
Electrical connection	Notes
Does the supply voltage match the specifications on the nameplate?	U = e.g. 19.2 to 30 V _{DC}  The device may only be powered by a power unit with an energy-limited circuit.
Are the power supply and signal cables connected correctly?	--
Are all the screw terminals well tightened and have the connections of the push-in terminals been checked?	--

7 Operation options

7.1 Display and operating elements

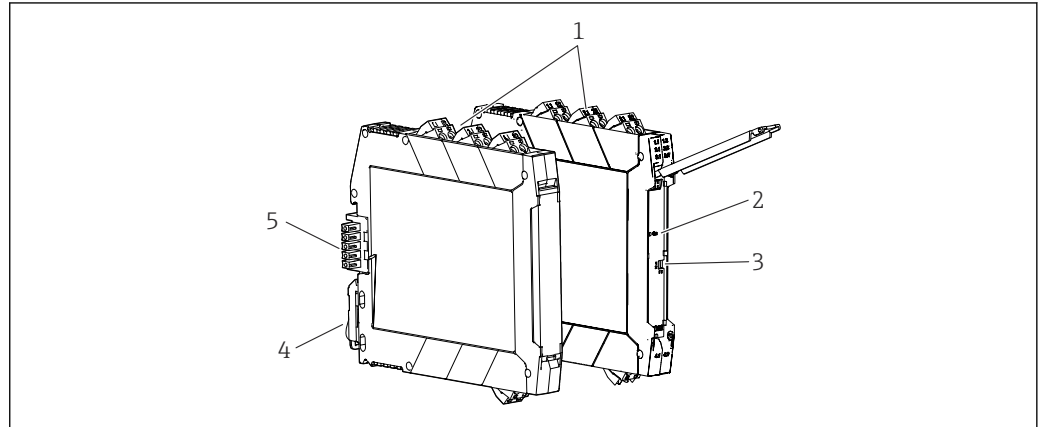

A0043926

7 Display and operating elements

- 1 Plug-in screw or push-in terminal with integrated test socket
- 2 Green LED "PWR" power supply
- 3 DIP switches (only on 1-channel version)
- 4 DIN rail clip for DIN rail mounting
- 5 DIN rail bus connector (optional)

7.1.1 Local operation

Hardware settings / configuration

 Any device settings using the DIP switch must be made when the device is de-energized.

Short-circuit detection

In the 1-channel version, short-circuit monitoring can be switched off or on using the DIP switches.

DIP switch	Short-circuit detection Off	Short-circuit detection On
1	I	II
2	I	II

 Short-circuit detection must be disabled for 0 to 20 mA signal transmission. Otherwise, the signal range can only be used as of the line fault detection response threshold of >0.2 mA.

8 Commissioning

8.1 Post-installation check

Before commissioning the device, ensure that all installation and post-connection checks have been carried out.

NOTICE

- ▶ Before commissioning the device, make sure that the supply voltage matches the voltage specifications on the nameplate. Failure to perform these checks may result in damage to the device caused by the incorrect supply voltage.

8.2 Switching on the device

Switch on supply voltage. The green LED display on the front of the device indicates that the device is operational.

9 Diagnostics and troubleshooting

9.1 General troubleshooting

Always start troubleshooting with the checklists below if faults occur after startup or during operation. The checklists take you directly (via various queries) to the cause of the problem and the appropriate remedial measures.

 Due to its design, the device cannot be repaired. However, it is possible to send the device in for examination. See the information in the "Return" section.

General errors

Error	Possible cause	Remedial action
Device is not responding.	Supply voltage does not match the specification on the nameplate.	Check the voltage directly using a voltmeter and correct.
	Connecting cables are not in contact with the terminals.	Ensure electrical contact between the cable and the terminal.
	Electronics unit is defective.	Replace the device.
HART communication is not working.	Communication resistor missing or incorrectly installed.	Install the communication resistor ($\geq 230 \Omega$) correctly.
	HART modem is not properly connected.	Connect HART modem correctly.
	HART modem is not set to "HART".	Set HART modem selector switch to "HART".
The power LED on the DIN rail device is not lit (green).	Power failure or insufficient supply voltage.	Check the supply voltage and check if wiring is correct.

10 Maintenance

No special maintenance work is required for the device.

Cleaning

A clean, dry cloth can be used to clean the device.

11 Repair

11.1 General information

Due to its design, the device cannot be repaired.

11.2 Spare parts

Spare parts currently available for the device can be found online at: http://www.products.endress.com/spareparts_consumables. Always quote the serial number of the device when ordering spare parts!

Type	Order code
Plug-in terminal set, 2-pin, DIN rail interfaces - screw	71505292
Plug-in terminal set, 2-pin, DIN rail interfaces - push-in	71505320
Front cover 12.5 mm, DIN rail housing (5 pcs per pack)	71505347

11.3 Return

The requirements for safe device return can vary depending on the device type and national legislation.

1. Refer to the website for more information:
<http://www.endress.com/support/return-material>
2. Return the device if repairs or a factory calibration are required, or if the wrong device was ordered or delivered.

11.4 Disposal



If required by the Directive 2012/19/EU on waste electrical and electronic equipment (WEEE), the product is marked with the depicted symbol in order to minimize the disposal of WEEE as unsorted municipal waste. Do not dispose of products bearing this marking as unsorted municipal waste. Instead, return them to the manufacturer for disposal under the applicable conditions.

12 Technical data

12.1 Function and system design

Product description RNO22

Product design

Output isolating amplifier, 1-channel

- With the "1-channel" option, the output isolating amplifier is used to control I/P converters, control valves and indicators. The device separates and transmits 0/4 to 20 mA signals. For operating the SMART actuators, the analog measuring value can be overlaid with digital communication signals (HART) and transmitted bidirectionally in an electrically isolated manner.
- Sockets for the connection of HART communicators are integrated in the plug-in connectors. The device enables open-circuit and short-circuit monitoring. Short-circuit monitoring can be switched off or on using the DIP switches. An open or shorted field circuit causes a high input impedance on the controller side. This enables open-circuit and short-circuit monitoring by the control system. A green LED indicates that the device is ready for operation.
- The device is optionally available with Ex approvals for the intrinsically safe operation of I/P converters, control valves and indicators installed in the hazardous area. Separate Ex documentation (XA) is supplied with these devices. Compliance with the installation instructions and connection data in this documentation is mandatory!

Output isolating amplifier, 2-channel

With the "2-channel" option, the device has a second channel, which is galvanically isolated from channel 1, while maintaining the same width. In the 2-channel version, short-circuit monitoring **cannot** be switched off or on using the DIP switches. Otherwise, the function corresponds to the 1-channel device.

Dependability

We only provide a warranty if the device is installed and used as described in the Operating Instructions.

12.2 Input

Version

The following versions are available:

- 1-channel
- 2-channel

Input data, measuring range

Current input signal:	
Input current	≤ 30 mA
Input impedance in event of line fault at output	> 1 MΩ (if line fault is present)
Voltage drop	< 2.4 V (at 20 mA)
Function (short-circuit detection off; 1-channel only)	0 to 20 mA
Function (short-circuit detection on; 1-channel only)	0.2 to 20 mA
Function (2-channel)	0.2 to 20 mA
Safety	4 to 20 mA
Underload/overload range	0 to 24 mA
Line fault detection: input current response threshold	> 0.2 mA

12.3 Output

Output data	Current output signal: Function (short-circuit detection off; 1-channel only) Function (short-circuit detection on; 1-channel only) Function (2-channel) Safety Underload/overload range	0 to 20 mA 0.2 to 20 mA 0.2 to 20 mA 4 to 20 mA 0 to 24 mA
	Open-circuit voltage	≤ 27 V
	Transmission behavior	1:1 to input signal
	Load: Short-circuit detection on (20 / 24 mA) Short-circuit detection off (20 / 24 mA)	100 to 700 Ω / 500 Ω 0 to 700 Ω / 500 Ω
	Transmissible communication protocols	HART
	Output ripple	< 20 mV _{rms}

Error detection	Wire break detection	Load > 10 kΩ
	Short-circuit detection	Load < 50 Ω

Ex connection data See associated XA Safety Instructions

Galvanic isolation	<i>At operating altitude ≤ 2 000 m (6 562 ft):</i>	
	Input / output; output / power supply: Rated insulation voltage Test voltage Insulation	300 V _{rms} 2.5 kVAC (50 Hz, 1 min.) Safe isolation according to IEC/EN 61010-1
	Input / power supply: Rated insulation voltage Test voltage Insulation	50 V _{rms} 1.5 kVAC (50 Hz, 1 min.) Safe isolation according to IEC/EN 61010-1
	Input 1 / input 2; Output 1 / output 2 (2-channel devices): Test voltage	1.5 kVAC (50 Hz, 1 min.)
	Output / input; output / power supply (peak value according to EN 60079-11)	375 V
	Output 1 / output 2 (2-channel devices)	60 V

12.4 Power supply

Terminal assignment

Quick wiring guide

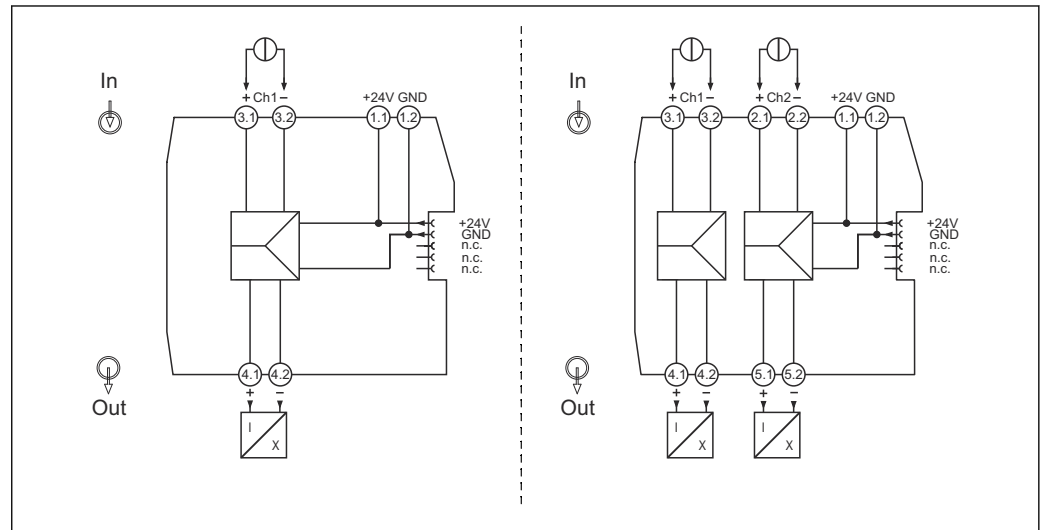

8 Terminal assignment of RNO22: 1-channel version (left), 2-channel version (right)

i Sockets for the connection of HART communicators are integrated in the plug-in connectors (screw connection). Ensure an adequate external resistance ($\geq 230 \Omega$) in the output circuit.

Connecting the supply voltage

Power can be supplied via terminals 1.1 and 1.2 or via the DIN rail bus connector.

Using the power and error message module to supply power

It is recommended to use the RNF22 power and error message module to provide the supply voltage to the DIN rail bus connector. An overall current of 3.75 A is possible with this option.

Supply to the DIN rail bus connector via terminals

Devices installed side by side can be powered via the terminals of the device up to a total current consumption of 400 mA. The connection is via the DIN rail bus connector. The installation of a 630 mA fuse (semi-delay or slow-blow) upstream is recommended.

NOTICE

The simultaneous use of terminals and DIN rail bus connectors to supply power is not permitted! The tapping of energy from the DIN rail bus connector for further distribution is not permitted.

► The supply voltage must never be connected directly to the DIN rail bus connector!

Performance characteristics

Supply voltage	24 V _{DC} (-20% / +25%)	Maximum current consumption at 24 V _{DC} / 20 mA	1-channel: < 45 mA 2-channel: < 85 mA
Power loss at 24 V _{DC} / 20 mA	1-channel: < 0.8 W 2-channel: < 1.4 W	Maximum power consumption at 24 V _{DC} / 20 mA	1-channel: ≤ 1.1 W 2-channel: < 2 W

Power supply failure To meet the requirements of SIL and NE21, voltage interruptions of up to 20 ms must be bridged with a suitable power supply.

Terminals A flat-blade screwdriver is required to establish an electrical connection to screw or push-in terminals.

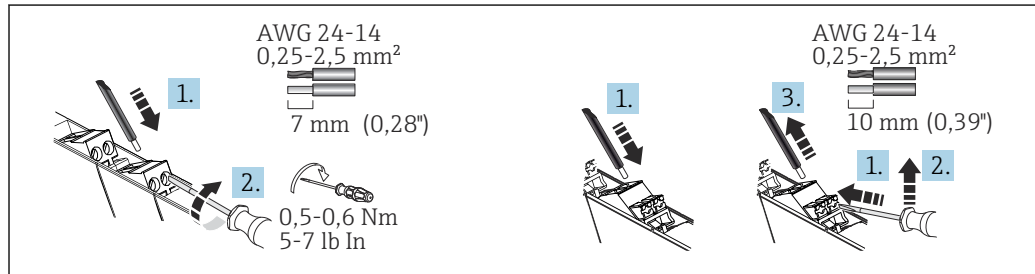

9 Electrical connection using screw terminals (left) and push-in terminals (right)

Terminal design	Cable design	Cable cross-section
Screw terminals Tightening torque: minimum 0.5 Nm/maximum 0.6 Nm	Rigid or flexible (Stripping length = 7 mm (0.28 in))	0.2 to 2.5 mm ² (24 to 14 AWG)
	Flexible with wire end ferrules (with or without plastic ferrule)	0.25 to 2.5 mm ² (24 to 14 AWG)
Push-in spring terminals	Rigid or flexible (Stripping length = 10 mm (0.39 in))	0.2 to 2.5 mm ² (24 to 14 AWG)
	Flexible with wire end ferrules (with or without plastic ferrule)	0.25 to 2.5 mm ² (24 to 14 AWG)

Cable specification A shielded cable is recommended for HART communication. Observe grounding concept of the plant.

12.5 Performance characteristics

Response time	Step response (10 to 90 %)	< 140 μs (with step 4 to 20 mA)
----------------------	----------------------------	---------------------------------

Maximum measured error	<i>Accuracies</i>	
	Transmission error (typical / maximum)	0.05 % / 0.1 % of full scale value
	Temperature coefficient (typical / maximum)	≤ 0.005 % / 0.01 %/K

12.6 Installation

Mounting location The device is designed for installation on 35 mm (1.38 in) DIN rails in accordance with IEC 60715 (TH35).

The device's housing provides basic insulation from neighboring devices for 300 Veff. If several devices are installed side by side, this must be taken into consideration and additional insulation must be provided if necessary. If the adjacent device also offers basic insulation, no additional insulation is required.

NOTICE

- ▶ When using in hazardous areas, the limit values of the certificates and approvals must be observed.

i For information on ambient conditions, see the "Technical data" section.

Installing a DIN rail device

The device can be installed in any position (horizontal or vertical) on the DIN rail without lateral clearance from neighboring devices. No tools are required for installation. The use of end brackets (type "WEW 35/1" or similar) on the DIN rail is recommended to fix the device.

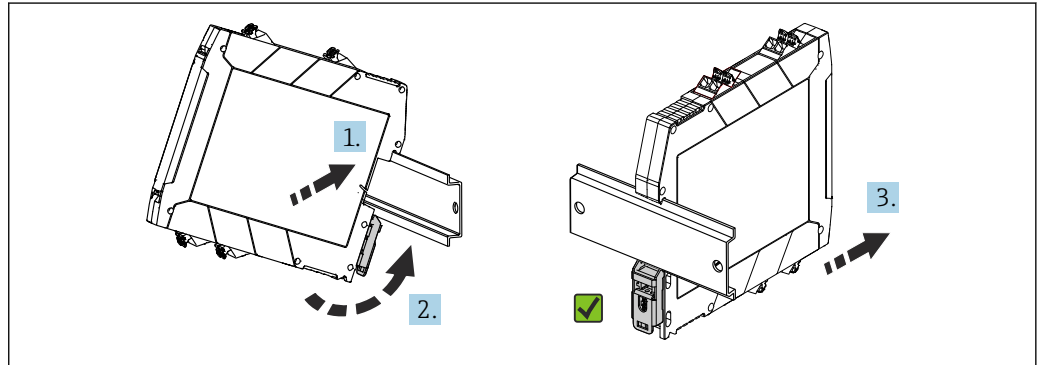

10 Installing on DIN rail

1. Position the top DIN rail groove at the top end of the DIN rail.
2. While holding the front of the device horizontally, lower it until you hear the locking clip of the device click into place on the DIN rail.
3. Pull gently on the device to check if it is correctly mounted on the DIN rail.

12.7 Environment

Important ambient conditions

Ambient temperature range	-40 to 70 °C (-40 to 158 °F)	Storage temperature	-40 to 85 °C (-40 to 185 °F)
Degree of protection	IP 20	Overvoltage category	II
Pollution degree	2	Humidity	5 to 95 % no condensation

Operating altitude ranges

Description	Ex applications	Ex applications
Altitude	≤ 2 000 m (6 562 ft)	≤ 3 000 m (9 843 ft)
Ambient temperature (operation)	-40 to 70 °C (-40 to 158 °F)	-40 to 60 °C (-40 to 140 °F)
Max. voltage U_m (non-intrinsically safe circuits)	253 V _{AC}	190 V _{AC}
Max. voltage U_m (non-intrinsically safe circuits)	125 V _{DC}	110 V _{DC}
Rated insulation voltage (power supply, input / output)	320 V	190 V
Description	Ex applications	Ex applications
Altitude	≤ 4 000 m (13 123 ft)	≤ 5 000 m (16 404 ft)
Ambient temperature (operation)	-40 to 55 °C (-40 to 131 °F)	-40 to 45 °C (-40 to 113 °F)
Max. voltage U_m (non-intrinsically safe circuits)	60 V _{AC}	60 V _{AC}
Max. voltage U_m (non-intrinsically safe circuits)	60 V _{DC}	60 V _{DC}
Rated insulation voltage (power supply, input / output)	63 V	63 V

Description Altitude Ambient temperature (operation) Rated insulation voltage (power supply, input / output)	Non-Ex applications (EN 61010-1) ≤ 2 000 m (6 562 ft) -40 to 70 °C (-40 to 158 °F) 300 V	Non-Ex applications (EN 61010-1) ≤ 3 000 m (9 843 ft) -40 to 60 °C (-40 to 140 °F) 150 V
Description Altitude Ambient temperature (operation) Rated insulation voltage (power supply, input / output)	Non-Ex applications (EN 61010-1) ≤ 4 000 m (13 123 ft) -40 to 55 °C (-40 to 131 °F) 150 V	Non-Ex applications (EN 61010-1) ≤ 5 000 m (16 404 ft) -40 to 45 °C (-40 to 113 °F) 150 V

Shock and vibration resistance Vibration resistance as per DNVGL-CG-0339 : 2015 and DIN EN 60068-2-27
DIN rail device: 2 to 100 Hz at 0.7 g (general vibration stress)

Electromagnetic compatibility (EMC) **CE compliance**
Electromagnetic compatibility in accordance with all the relevant requirements of the IEC/EN 61326 series. For details, refer to the Declaration of Conformity.

- Interference immunity as per EN 61000-6-2
There may be minor deviations during the interference.
- Interference emission as per EN 61000-6-4

Marine approval **DNV GL TAA00000AG (optional)**
Temperature: B
Humidity: B
Vibration: A
Electromagnetic compatibility (EMC): B
Cabinet: In the event of installation on a ship, the necessary protection must be provided in accordance with regulations

12.8 Mechanical construction

Design, dimensions

Dimensions in mm (in)

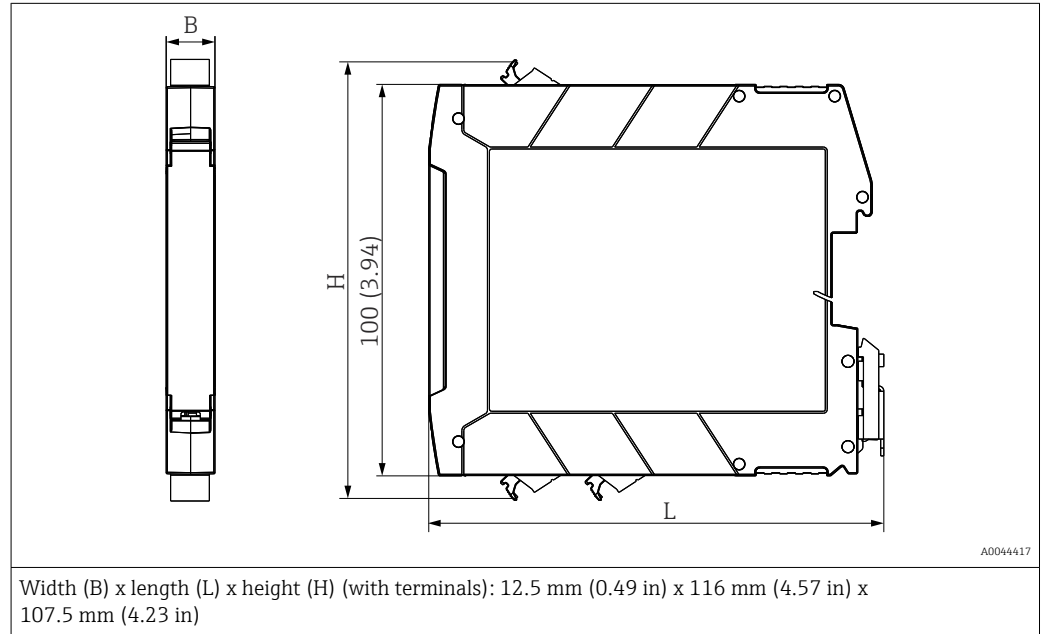
Terminal housing for mounting on DIN rail

Weight

Device with terminals (values rounded up):

1-channel: approx. 100 g (3.53 oz); 2-channel: approx. 120 g (4.23 oz)

Color

Light gray

Materials

All the materials used are RoHS-compliant.

Housing: polycarbonate (PC); flammability rating according to UL94: V-0

12.9 Display and operating elements

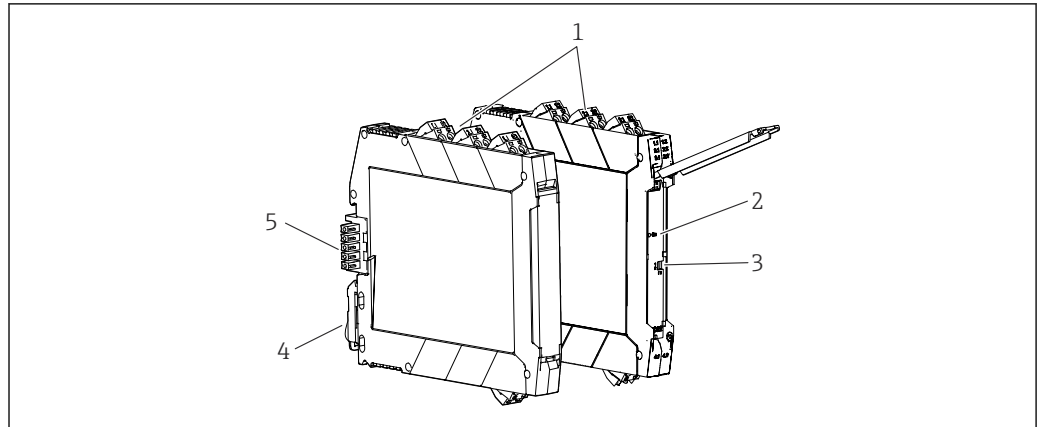

A0043926

11 Display and operating elements

- 1 Plug-in screw or push-in terminal with integrated test socket
- 2 Green LED "PWR" power supply
- 3 DIP switches (only on 1-channel version)
- 4 DIN rail clip for DIN rail mounting
- 5 DIN rail bus connector (optional)

Local operation

Hardware settings / configuration

i Any device settings using the DIP switch must be made when the device is de-energized.

Short-circuit detection

In the 1-channel version, short-circuit monitoring can be switched off or on using the DIP switches.

DIP switch	Short-circuit detection Off	Short-circuit detection On
1	I	II
2	I	II

i Short-circuit detection must be disabled for 0 to 20 mA signal transmission.

Otherwise, the signal range can only be used as of the line fault detection response threshold of >0.2 mA.

12.10 Ordering information

Detailed ordering information is available for your nearest sales organization www.addresses.endress.com or in the Product Configurator under www.endress.com :

1. Click Corporate
2. Select the country
3. Click Products
4. Select the product using the filters and search field
5. Open the product page

The Configuration button to the right of the product image opens the Product Configurator.



Product Configurator - the tool for individual product configuration

- Up-to-the-minute configuration data
- Depending on the device: Direct input of measuring point-specific information such as measuring range or operating language
- Automatic verification of exclusion criteria
- Automatic creation of the order code and its breakdown in PDF or Excel output format
- Ability to order directly in the Endress+Hauser Online Shop

12.11 Accessories

Various accessories, which can be ordered with the device or subsequently from Endress+Hauser, are available for the device. Detailed information on the order code in question is available from your local Endress+Hauser sales center or on the product page of the Endress+Hauser website: www.endress.com.

Device-specific accessories

Type	Order code
DIN rail bus connector 12.5 mm (x 1)	71505349
System power supply	RNB22
Power and error message module	RNF22

Service-specific accessories

Accessories	Description
Configurator	<p>Product Configurator - the tool for individual product configuration</p> <ul style="list-style-type: none"> ▪ Up-to-the-minute configuration data ▪ Depending on the device: Direct input of measuring point-specific information such as measuring range or operating language ▪ Automatic verification of exclusion criteria ▪ Automatic creation of the order code and its breakdown in PDF or Excel output format ▪ Ability to order directly in the Endress+Hauser Online Shop <p>The Configurator is available on the Endress+Hauser website at: www.endress.com -> Click "Corporate" -> Select your country -> Click "Products" -> Select the product using the filters and search field -> Open product page -> The "Configure" button to the right of the product image opens the Product Configurator.</p>
W@M	<p>Life cycle management for your plant</p> <p>W@M offers assistance with a wide range of software applications over the entire process: from planning and procurement to the installation, commissioning and operation of the measuring devices. All the relevant information is available for every measuring device over the entire life cycle, such as the device status, device-specific documentation, spare parts etc.</p> <p>The application already contains the data of your Endress+Hauser device. Endress+Hauser also takes care of maintaining and updating the data records.</p> <p>W@M is available: Via the Internet: www.endress.com/lifecyclemanagement</p>



12.12 Certificates and approvals



For certificates and approvals valid for the device: see the data on the nameplate



Approval-related data and documents: www.endress.com/deviceviewer → (enter the serial number)

Functional safety	<p>A SIL version of the device is optionally available. It can be used in safety equipment in accordance with IEC 61508 up to SIL 2 (SC 3).</p> <p> Please refer to Safety Manual FY01037K for the use of the device in safety instrumented systems according to IEC 61508.</p> <p> Protection against modifications:</p> <p>As it is not possible to disengage the operating elements (keys and DIP switches), a lockable control cabinet is required for use in SIL applications. The cabinet must be locked by key. A normal electrical cabinet key does not suffice for this purpose.</p>
-------------------	--

12.13 Supplementary documentation

The following types of documentation are available in the Download Area of the Endress+Hauser website (www.endress.com/downloads):

-  For an overview of the scope of the associated Technical Documentation, refer to the following:
- *W@M Device Viewer* (www.endress.com/deviceviewer): Enter the serial number from nameplate
 - *Endress+Hauser Operations App*: Enter the serial number from the nameplate or scan the 2D matrix code (QR code) on the nameplate

Brief Operating Instructions (KA)	<p>Guide that takes you quickly to the 1st measured value</p> <p>The Brief Operating Instructions contain all the essential information from incoming acceptance to initial commissioning.</p>
-----------------------------------	---

Operating Instructions (BA)	<p>Your reference guide</p> <p>These Operating Instructions contain all the information that is required in various phases of the life cycle of the device: from product identification, incoming acceptance and storage, to mounting, connection, operation and commissioning through to troubleshooting, maintenance and disposal.</p>
-----------------------------	---

Safety Instructions (XA)	<p>Depending on the approval, the following Safety Instructions (XA) are supplied with the device. They are an integral part of the Operating Instructions.</p> <p> The nameplate indicates the Safety Instructions (XA) that are relevant to the device.</p>
--------------------------	--

Supplementary device-dependent documentation	<p>Additional documents are supplied depending on the device version ordered: Always comply strictly with the instructions in the supplementary documentation. The supplementary documentation is an integral part of the device documentation.</p>
--	---

13 Appendix: system overview of RN Series

13.1 Power supply of RN Series

13.1.1 General information on the power supply of Endress+Hauser isolating amplifiers

 Read the information leaflet enclosed in the package of the individual products.

NOTICE

Short-circuit hazard; risk of overvoltage

Material damage is possible

- ▶ The supply voltage must never be connected directly to the DIN rail bus connector

NOTICE

Short-circuit hazard; risk of overvoltage

Material damage is possible

- ▶ If a DIN rail bus connector is used, only a SELV or PELV circuit may be connected to the power supply terminals of the devices

Endress+Hauser RN(x)22 Series isolating amplifiers can be powered either via plug-in connectors on the bottom of the device or, if the devices are wired individually, via pluggable screw-in or push-in terminals. It can be very time-consuming to wire each device individually, particularly if many devices are used. For this reason, Endress+Hauser offers its customers the option of powering a complete standard DIN rail, fitted with isolating amplifiers, via a single power supply terminal - the "DIN rail bus connector". This eliminates the need for time-consuming single wiring, which can be susceptible to error.

Power supply to the DIN rail bus connector can be implemented as follows:

- Direct DC power feed-in at any single device in the group
- DC power feed-in via the RNF22 feed-in power and error message module
- Power supply via the RNB22 system power supply with wide range input
100 to 240 V_{AC} / 100 to 250 V_{DC}

13.1.2 Power supply options RN Series (24 V_{DC})

The RN Series devices Rx22 that are compatible with the DIN rail bus connector require a 24 V_{DC} power supply. In addition, RN42 active barriers and RLN42 NAMUR isolating amplifiers are also available with an extended supply voltage range of 24 to 230 V_{AC/DC}. However, these devices are powered individually and exclusively via the terminals on the device and are **not** suitable for power supply via the DIN rail bus connector.

Apart from the supply of power to individual devices directly via the terminals, multiple RNx22 devices can be powered via the DIN rail bus connector. This connector is powered with 24 V_{DC} and supplies power to all the connected isolating amplifiers. This eliminates the need for complex and time-consuming single wiring.

One way to power several devices is to use the RNF22 power and error message modules, which also offer short-circuit and line break detection. These modules also enable redundant power feed-in where necessary.

13.1.3 Direct 24 V_{DC} power feed-in at any single device in the group

This type of power feed-in is particularly useful if only a few (approx. 2-8) isolating amplifiers need to be powered and error monitoring is not required.

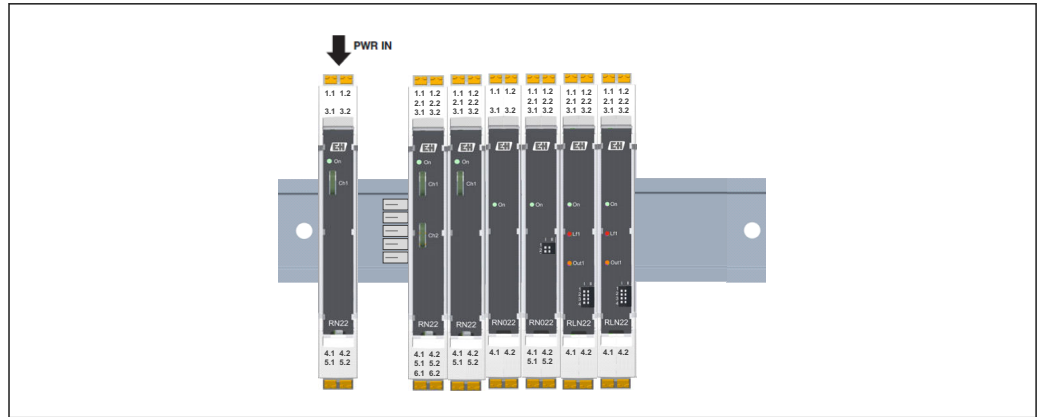

A0045541

12 Direct power feed-in at any device in the group

At a glance

- Solution for small installations with just a few devices (total power consumption $I_{max} < 400 \text{ mA}$)
- 24 V_{DC} power supply available in the cabinet
- Redundancy not required
- No group error evaluation of line or short-circuit monitoring (only relevant for RLN22 NAMUR isolating amplifier)

In the case of direct power feed-in, all the devices connected to the DIN rail bus connector are powered via the power supply at an isolating amplifier. In this configuration, please note that the maximum total power consumption of $I_{max} = 400 \text{ mA}$ may not be exceeded and therefore the maximum number of devices is limited. Please refer to the Brief Operating Instructions (KA) or Technical Information (TI) for information on the current consumption of the individual isolating amplifiers. The maximum number of devices is calculated using the following formula:

$$n_{\text{modules}} = I_{\text{max}} / I_N = (400 \text{ mA}) / I_N$$

$$I_N = n_1 \cdot I_{\text{module1}} + n_2 \cdot I_{\text{module2}} + \dots$$

A 500 mA fuse must be connected in series upstream. Furthermore, you must ensure that the 24 V_{DC} power supply used is guaranteed to trip the fuse in the event of an error.

Example: direct power feed-in via one device

You wish to supply power to four RN22 active barriers and three RLN22 NAMUR isolating amplifiers with an operating voltage of 24 V_{DC} . First consult the Brief Operating Instructions to determine the current consumption of the devices. This is 70 mA per device for the RN22 active barriers (1-channel), and 35 mA per device in the case of the RLN22 NAMUR isolating amplifiers (2-channel). The total current consumption must then be determined using the following formula:

$$I_N = n_1 \cdot I_{\text{module1}} + n_2 \cdot I_{\text{module2}} + \dots$$

$$I_N = 4 \cdot 70 \text{ mA} + 3 \cdot 35 \text{ mA} = 385 \text{ mA} < 400 \text{ mA}$$

Direct 24 V_{DC} power feed-in at any single device

$$I_{\text{max}} < 400 \text{ mA}$$

$$\text{Formula: } I_N < I_{\text{max}} < 400 \text{ mA; } I_N = n_1 \cdot I_{\text{module1}} + n_2 \cdot I_{\text{module2}} + \dots$$

Device (24 V_{DC})	Current consumption per device (mA)	Number of devices	Total current consumption (mA)
RN22 1-channel	70	4	280
RN22 2-channel	130	0	0

Device (24 V _{DC})	Current consumption per device (mA)	Number of devices	Total current consumption (mA)
RN22 signal doubler	100	0	0
RLN22 1-channel	21	0	0
RLN22 2-channel	35	3	105
RNO22 1-channel	45	0	0
RNO22 2-channel	85	0	0
	I _{max} : 400 mA	7	385

The total current consumption of 385 mA is less than the maximum permitted current of 400 mA. The fuse to be connected in series upstream from the power-supplying isolating amplifier should have a maximum rated current of 500 mA. To guarantee that the fuse trips in the event of a short-circuit, the 24 V_{DC} power is supplied in this example by an RNB22 power supply of 24 V_{DC} 2.5 A.

With this type of power feed-in, it is important to note that the maximum number of devices is very limited and that short-circuit and line break detection is not possible. Short-circuit and line break detection is provided by the power supply solution described in the next section.

13.1.4 Power supply via RNF22 power and error message module

This version is particularly well suited for a larger number of isolating amplifiers mounted side by side, e.g. in new installations. In addition, error monitoring can be implemented with this solution.

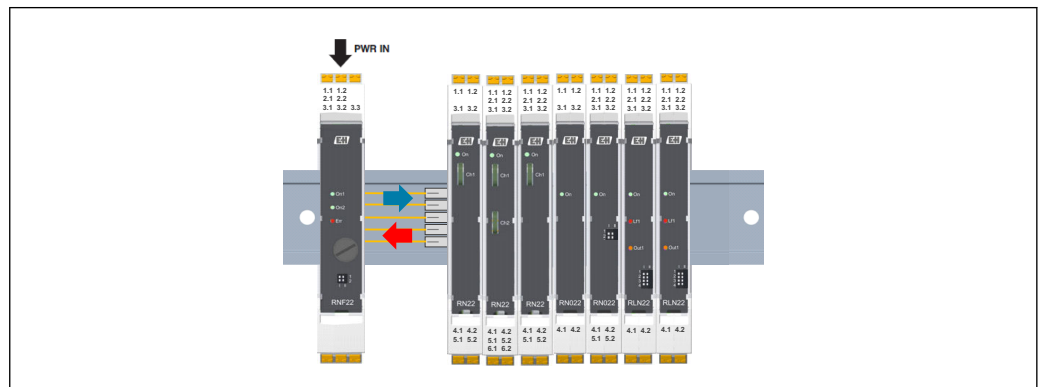

13 Power supply via RNF22 power and error message module

At a glance

- 24 V_{DC} power supply available in the cabinet
- Maximum current consumption of connected RN devices (total current consumption I_{max} < 3.75 A)
- Redundant power feed-in possible via two power supplies
- Group error message, line or short-circuit monitoring of side-by-side RLN22 NAMUR isolating amplifiers

RNF22 power modules are particularly suitable for supplying power to RNx22 devices. Here, a total current of 3.75 A can be realized. These modules also offer the additional advantage of integrated error evaluation. A power supply failure or fuse error is signaled by a relay contact and indicated by a flashing LED. The power feed-in can be redundant if required. The diodes integrated in the device ensure the separation of the power supplies used for power feed-in. In addition, mechanical redundancy is also possible by using two power supply terminals. The power supply terminal(s) are each fused by an integrated 5 A fuse.

Irrespective of whether you are using one or two RNF22 power modules, you can calculate the maximum number of devices using the following formula and the information in the Brief Operating Instructions:

$$n_{\text{modules}} = I_{\text{max}}/I_{\text{N}} = (3.75 \text{ A})/I_{\text{N}}$$

$$I_{\text{N}} = n_1 \cdot I_{\text{module1}} + n_2 \cdot I_{\text{module2}} + \dots$$

If power feed-in is via the RNF22 power modules, power can be supplied by a single RNB22 power supply. Alternatively, redundant power feed-in by two different power supplies is also possible.

13.1.5 Power supply via the RNB22 system power supply and RNF22 power module (redundant)

The advantage of this version with power feed-in to the DIN rail bus connector is that a 24 V_{DC} power supply does not have to be available in the cabinet. This type of power feed-in is the best solution particularly for decentralized applications where only 230 V_{AC} is available.

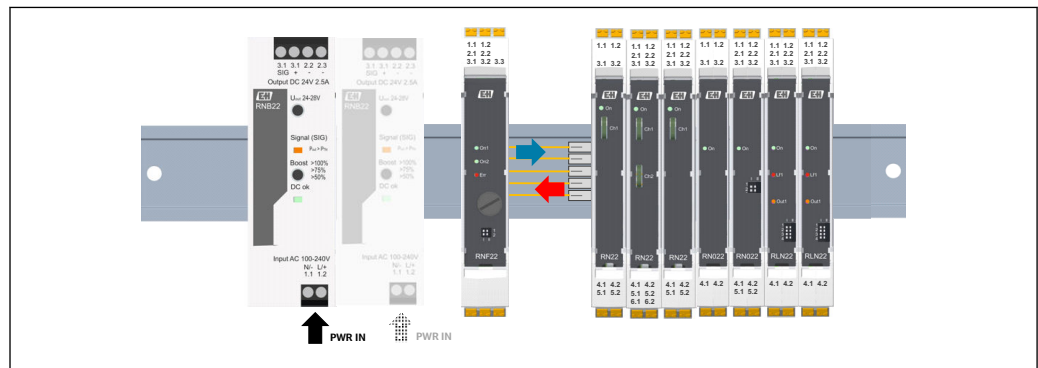

14 Power supply via "optional redundant" RNB22 system power supply and RNF22 power module

At a glance

- Single or redundant power feed-in via two RNB22 (2.5 A) power supplies and one RNF22 power module
- Redundancy with total load up to 2.5 A (at 60 °C ambient temperature)
- Maximum load 3.75 A via RNF22 power module
- Can be used if 24 V_{DC} power supply is not available in cabinet
- Group error message, line or short-circuit monitoring of side-by-side RLN22 NAMUR isolating amplifiers

Power feed-in via the RNF22 power and error message module can be via one RNB22 system power supply, or via two RNB22 system power supplies (redundant configuration). In this case it is important that both power circuits of the RNB22 are separately fused. With this type of power supply, a maximum of 3.75 A can be fed into the DIN rail bus connector.

Example: power feed-in via redundant RNB22 system power supply and one RNF22 power module

You wish to supply power to 15 RN22 active barriers (1-channel), 5 RN22 active barriers (2-channel), 3 RN22 signal doublers, 12 RLN22 NAMUR isolating amplifiers (1-channel) and 5 RNO22 output isolating amplifiers (1-channel) with an operating voltage of 24 V_{DC}.

First consult the Brief Operating Instructions to determine the current consumption of the devices. For the intrinsically safe RN22 active barriers this is 70 mA (1-channel), 130 mA (2-channel) and 100 mA (signal doubler) per device, and 21 mA in the case of the RLN22 NAMUR isolating amplifiers (1-channel). The RNO22 output isolating amplifiers (1-channel) each require 45 mA.

The total current consumption must then be determined using the following formula:

$$I_N = n_1 \cdot I_{\text{module1}} + n_2 \cdot I_{\text{module2}} + \dots$$

Power feed-in via RNF22 power module with redundancy

RNB22: 2.5 A (I_N) at $T_a \leq 60^\circ\text{C}$

Formula: $I_N < I_{\text{max}} < 2.5\text{ A}$; $I_N = n_1 \cdot I_{\text{module1}} + n_2 \cdot I_{\text{module2}} + \dots$

Device (24 V _{DC})	Current consumption per device (mA)	Number of devices	Total current consumption (mA)
RN22 1-channel	70	15	1050
RN22 2-channel	130	5	650
RN22 signal doubler	100	3	300
RLN22 1-channel	21	12	252
RLN22 2-channel	35	0	0
RNO22 1-channel	45	5	225
RNO22 2-channel	85	0	0
	I_{max} : 2 500 mA	40	2477

The total current consumption of 2 477 mA is less than the nominal current ($I_N=2.5\text{ A}$) of the RNB22 at 60°C ambient temperature and less than the maximum permitted current of the RNF22 power module (max. 3 750 mA). To ensure a redundant power supply and to guarantee that the fuse integrated in the RNF22 trips in the event of a short-circuit, the 24 V_{DC} power is supplied in this example by two RNB22 power supplies 2.5 A / 24 V_{DC}, which each provide a short-circuit current of 5.6 A.

Please note: in this arrangement, the power supply to all the isolating amplifiers is interrupted if the RNF22 power and error message module fails.

13.1.6 Example: power feed-in via two RNF22 power modules (redundant)

If you require a redundant power supply via two RNF22 power modules, each device must be powered from a separate voltage supply. These supplies should be arranged outside on the DIN rail in order to limit the maximum short-circuit current in the event of an error.

Without redundancy and with power supplies operating in static boost mode, a maximum current of 3.15 A may not be exceeded for each power supply side in this solution. To increase the total number of isolating amplifiers mounted side by side, a maximum current of 6 A can be fed into the DIN rail bus connector via the two power supply terminals.

At a glance

- "Full" redundancy with power feed-in via two RNB22 and two RNF22 power modules and maximum load of 2.5 A at 60°C ambient temperature
- If redundancy is not required, maximum system load of up to 6 A is possible ($2 \cdot 3.15\text{ A}$ static boost)
- Group error message, line or short-circuit monitoring of RLN22 NAMUR isolating amplifiers

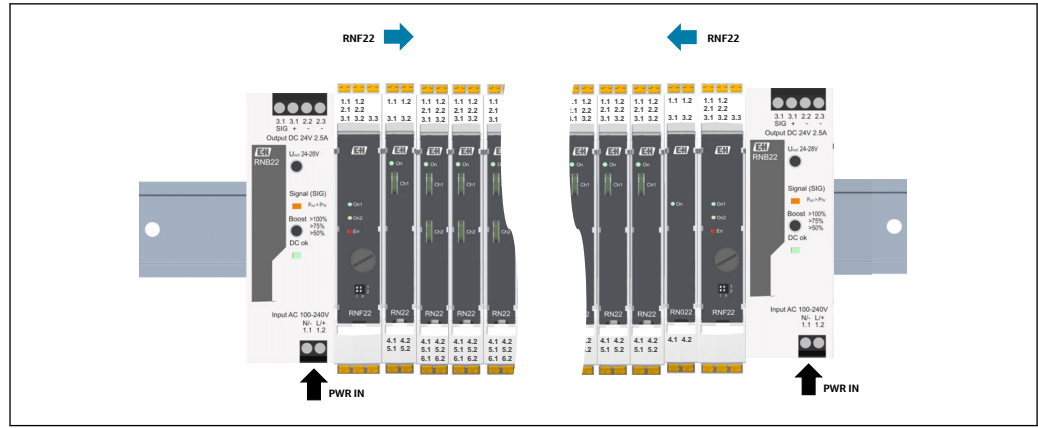

15 Example of power feed-in via two RNF22 power modules

Please note: with a load of up to 2.5 A, the power supply is redundant with ambient temperatures up to 60 °C.

Example: power feed-in via two RNF22 power modules

You wish to operate the system at maximum possible load without redundancy and with power supplied to 20 RN22 active barriers (1-channel), 10 RN22 active barriers (2-channel), 5 RN22 signal doublers, 20 RLN22 NAMUR isolating amplifiers (1-channel), 20 RLN22 (2-channel), 15 RNO22 output isolating amplifiers (1-channel) and 10 RNO22 (2-channel) at an operating voltage of 24 V_{DC}.

First consult the Brief Operating Instructions to determine the current consumption of the devices. For the intrinsically safe RN22 active barriers this is 70 mA (1-channel) and 130 mA (2-channel) per device, 100 mA for the RN22 signal doubler, 21 mA for the RLN22 NAMUR isolating amplifier (1-channel) and 45 mA in the case of the RLN22 (2-channel). We take the current consumption of each RNO22 output isolating amplifier (1-channel) to be 45 mA, and that of each RNO22 (2-channel) to be 85 mA.

The total current consumption must then be determined using the following formula:

$$I_N = n_1 \cdot I_{\text{module1}} + n_2 \cdot I_{\text{module2}} + \dots$$

Power feed-in via two RNF22 power and error modules

$$2 \cdot \text{RNB22} + 2 \cdot \text{RNF22}: 2 \cdot 3.15 \text{ A (static boost)} \rightarrow 6 \text{ A (at } T_a = 40 \text{ °C)}$$

$$\text{Formula: } I_N = n_1 \cdot I_{\text{module1}} + n_2 \cdot I_{\text{module2}} + \dots$$

Device (24 V _{DC})	Current consumption per device (mA)	Number of devices	Total current consumption (mA)
RN22 1-channel	70	20	1400
RN22 2-channel	130	10	1300
RN22 signal doubler	100	5	500
RLN22 1-channel	21	20	420
RLN22 2-channel	35	20	700
RNO22 1-channel	45	15	675
RNO22 2-channel	85	10	850
	Imax: 6 000 mA	100	5845

The total current consumption of 5 845 mA is less than the maximum permitted current with two power supplies (max. 6 A) in static boost mode. To ensure that the fuse integrated in the RNF22 power modules is guaranteed to trip in the event of a short-

circuit, the $24 V_{DC}$ power is supplied in this example by two RNB22 power supplies, which provide a short-circuit current of $2 \cdot 5.6 A = 11.2 A$.

13.2 Applications of the RN Series devices

This section describes the typical applications of the RN Series devices.

These devices perform various functions during signal conditioning:

- Amplification
- Normalization
- Filtering
- Galvanic isolation
- Supply of electrical power to connected sensors
- Line monitoring

The devices for these tasks are collectively known as isolating amplifiers or signal isolators and are available with different functions in the Endress+Hauser RN Series. Different types of signals are conditioned in this context.

13.2.1 Types of signals

Signals are referred to as **analog** signals if they can continuously assume every value between a minimum and maximum value (e.g. 0/4-20 mA) and are therefore also known as "value-continuous" signals. The value range in this interval is huge and is practically infinite in terms of measuring accuracy.

Electrical analog signals are generated with the help of a sensor, for example, which records the states, or changes of state, of physical variables and converts them to an electrical signal.

The following variables are typically measured in system and process engineering using Endress+Hauser measuring devices:

- Temperature
- Pressure
- Level
- Flow
- Analysis values (e.g. turbidity, conductivity, pH etc.)

These analog signals are evaluated in the controller (PLC) and the signals can be used in a "target device": e.g. for

- Display devices, e.g. level indication via RIA15
- Control unit, e.g. level control
- Actuators, e.g. to fill a tank

A transmitter can also be connected downstream of the sensor. This transmitter converts the analog measured value signal to a standard signal and thereby enables the further processing of the signal with additional standardized, electrical modules. The transmitter can also be integrated in the sensor housing.

Binary signals only assume two values and signal the states "on" or "off" / "1" or "0" with these values. Binary signals are often equated with "digital" signals because digital signals are generally binary encoded.

HART (Highway Addressable Remote Transducer) signals are essentially characterized by the fact that they are operated and used as a complement to classic analog standard signals, in contrast to other digital fieldbus systems. HART therefore does not replace point-to-point wiring but rather enables the integration of smart field devices. The digital signals are modulated onto an analog 4 to 20 mA standard current signal using HART modulation in order to transmit digital information in addition to the analog information of the process value.

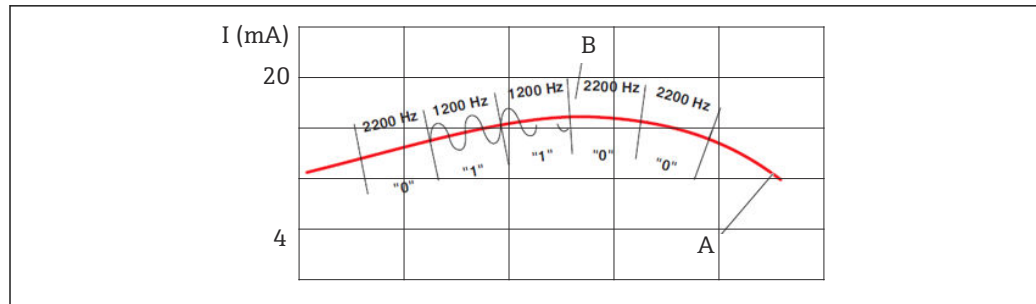

A0045578

16 Modulated HART signal

A Analog signal

B Digital signal

NAMUR sensors are operated with a transmitted current and have four states so that sensor errors can also be detected by an analog evaluation unit. This is sometimes referred to as the "closed circuit current principle".

NAMUR sensors can adopt four states at the output:

- Current 0 mA: wire break; circuit open
- Current <1.2 mA: sensor ready, undamped
- Current >2.1 mA: sensor ready, damped
- Current maximum value >6 mA: short-circuit, maximum current

The portfolio of the RN Series offers the following function modules:

- RN22, RN42 active barrier
- RN22 signal doubler
- RLN22, RLN42 NAMUR isolating amplifier
- RNO22 output isolating amplifier

13.2.2 RN22 active barrier

The active barriers perform several functions. In addition to galvanic signal isolation and the proportional transmission of analog 0/4-20 mA signals, they also provide power to connected sensors. The RN22 devices are HART-transparent, i.e. they also transmit the HART information supplied by the PMP71B. Via the HART connections on the front, HART signals can be measured or connected "SMART" sensors can be easily configured.

The following are examples of typical applications of the RN22 active barrier. Each application is explained briefly and described in a schematic diagram.

Example: pressure measurement in a hazardous area

- The passive 2-wire PMP71B sensor supplies a current signal, which is proportional to the pressure, to the active input of the RN22 active barrier
- The RN22 active barrier supplies an active current output signal, which is proportional to the input signal, to a passive input of the evaluation unit

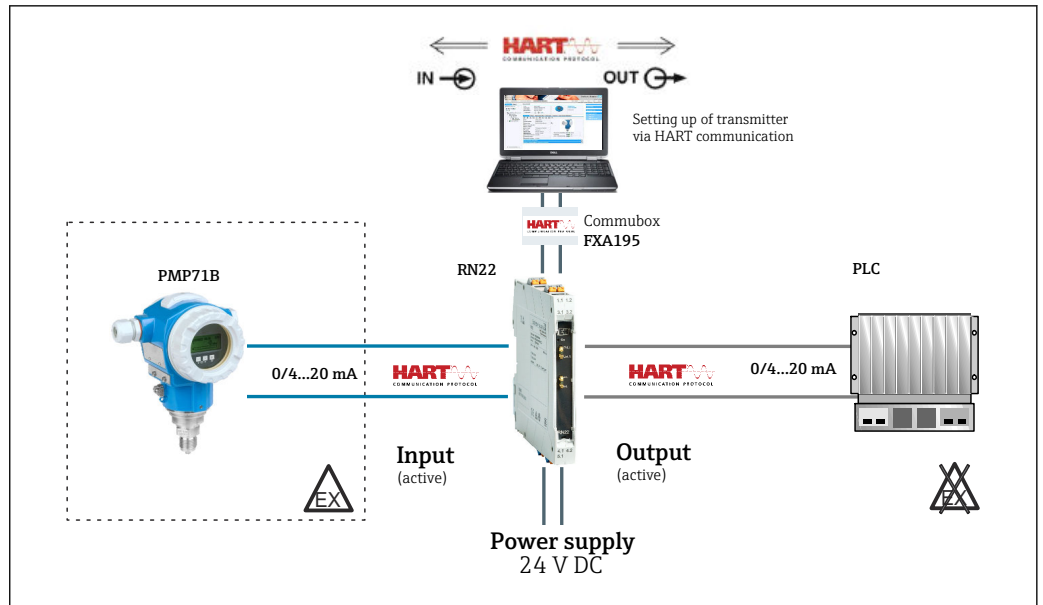

A0045579

17 Pressure measurement in a hazardous area with an RN22 active barrier

Please note: the devices have an active and passive current input to which a 2-wire or 4-wire transmitter can be directly connected. The output of the device can be operated actively or passively. The current signal is then available to the PLC / controller or to other instrumentation.

Example: flow measurement in a hazardous area

- The active 4-wire Promag P300 sensor supplies a current signal, which is proportional to the flow, to the passive input of the isolating amplifier
- The RN22 active barrier supplies a passive current output signal, which is proportional to the input signal, to an active input of the evaluation unit

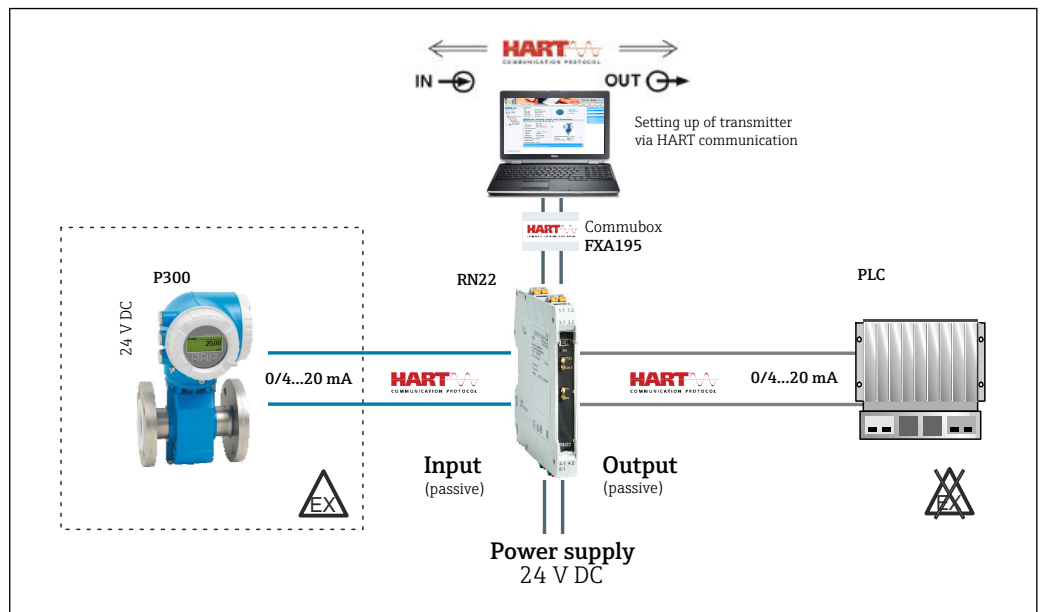

A0045580

18 Flow measurement in the hazardous area with an RN22 active barrier

Example: flow measurement in a hazardous area – signal doubling

- The passive 2-wire Prowirl F200 sensor supplies a current signal, which is proportional to the flow, to the active input of the isolating amplifier
- The RN22 signal doubler supplies the HART signal and an active current output signal, which is proportional to the input signal, to a passive input of the RSG45 data manager
- The RN22 signal doubler supplies an active current output signal, which is proportional to the input signal, to a passive input of the controller (HART signal filtered)

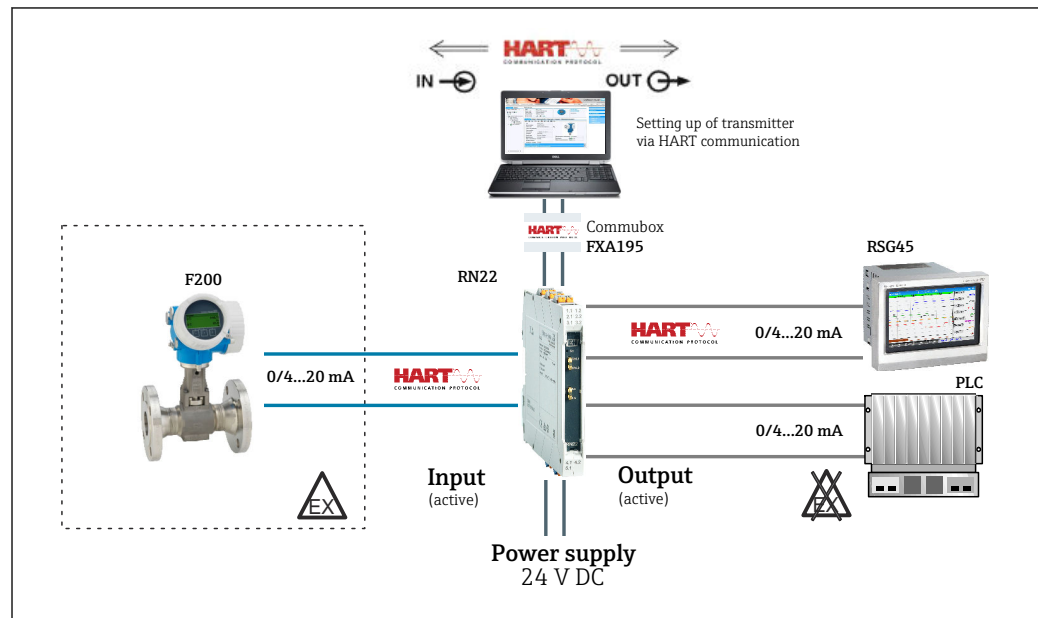

19 Flow measurement in the hazardous area with an RN22 signal doubler

Please note: the outputs can be operated as active or passive outputs independently of one another.

13.2.3 RLN22 NAMUR isolating amplifier

The NAMUR isolating amplifiers isolate and convert the analog NAMUR signal of connected proximity or limit switches to binary relay output states.

The abbreviation "NAMUR" is based on the former association name "Normen Arbeitsgemeinschaft für Mess- und Regeltechnik in der chemischen Industrie (Standardization Association for Measurement and Control in Chemical Industries)". While NAMUR's subtitle has since changed, the abbreviation has been kept. NAMUR sensors are proximity sensors or limit switches that are widely used in process automation. Endress+Hauser offers capacitance, conductive and vibronic sensors for the various applications. The electrical properties of sensors according to the NAMUR standard and their measuring characteristics are standardized. Therefore, they are vendor-independent and replacement is not restricted to the products of a specific vendor. NAMUR sensors are short-circuit proof. A short-circuit and line break in the sensor line can be detected by the RLN22 evaluating unit. A NAMUR sensor does not need a separate power supply: its power is supplied via the measuring circuit.

The operating voltage of the field loop in the "NAMUR measuring circuit" should be 8 ± 1 Volt, and the load on short-circuit between 100 to 360 Ω .

NAMUR sensors are operated with a transmitted current and have four states so that sensor errors can also be detected by an analog evaluation unit. This is sometimes referred to as the "closed circuit current principle".

NAMUR sensors can adopt four states at the output:

- Current 0 mA: wire break; circuit open
- Current <1.2 mA: sensor ready, undamped
- Current >2.1 mA: sensor ready, damped
- Current maximum value >6 mA: short-circuit, maximum current

A common application of NAMUR sensors is limit value monitoring in process automation. For this, analog signals are often only evaluated in a binary manner for a controller, e.g. if the application involves monitoring the level in a tank or monitoring a temperature, whereby a counteraction should be triggered if a limit value is exceeded. Here, the temperature currently measured can only be used to determine whether the temperature is above or below the limit value, for example.

The following are examples of typical applications of the RLN22 NAMUR isolating amplifier. Each application is explained briefly and described in a schematic diagram.

Example: digital isolating amplification of NAMUR sensor signals from a hazardous area

- The passive Liquiphant FTL41 sensor with the FEL48 evaluation unit supplies a NAMUR signal value 1.2 mA or 2.1 mA to the active input of the isolating amplifier
- The RLN22 NAMUR isolating amplifier supplies a binary output signal (relay contact), which depends on the input signal, to a digital input of the controller
- Line breaks or short-circuits of the 2-wire sensor line are indicated by LEDs on the RLN22, and - if the DIN rail bus connector is used - are reported as a group error message to the RNF22 power and error message module

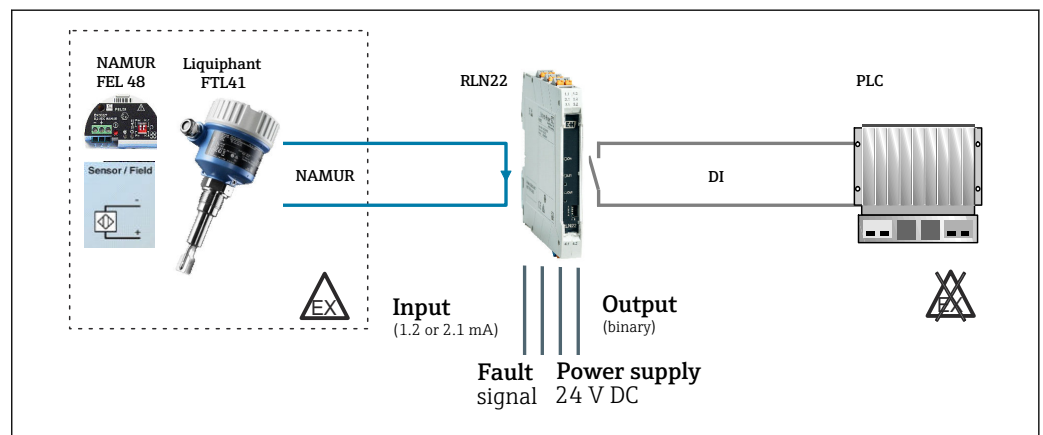

20 NAMUR limit detection, Liquiphant FTL41 with FEL48 NAMUR evaluation in the hazardous area

Example: signal isolation of sensors with mechanical contacts from a hazardous area

- The FTE20 rotary paddle switch reports the state via a mechanical switching contact
- The sensor and the connecting cables are monitored for line breaks and short-circuiting via the resistive coupling element, which is available as an accessory for the RLN22
- The RLN22 NAMUR isolating amplifier supplies a binary output signal, which depends on the input signal, to a digital input of the controller
- Line breaks or short-circuits of the 2-wire sensor line are indicated by LEDs on the RLN22, and - if the DIN rail bus connector is used - are reported as a group error message to the RNF22 power and error message module. At the same time, the output relay de-energizes to the currentless state.

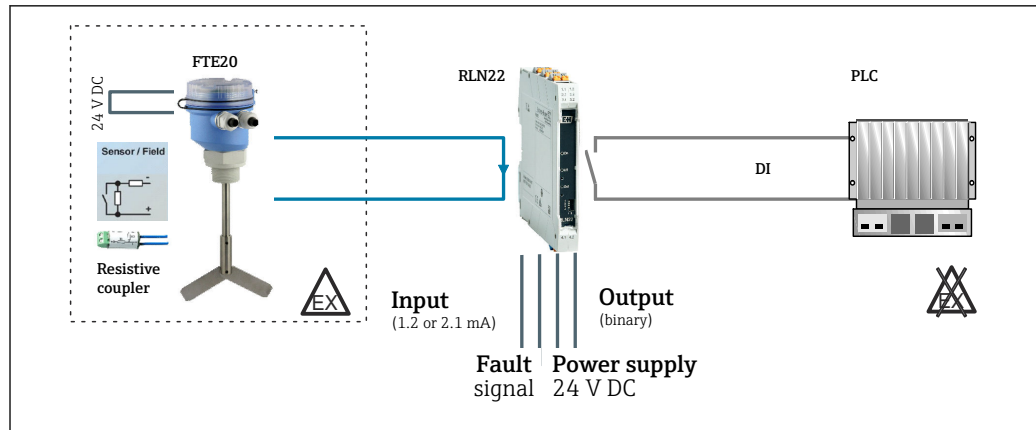

A0045583

21 NAMUR limit detection with FTE20 paddle switch with line monitoring in the hazardous area

Line monitoring for line breaks and short-circuiting can be implemented with the resistive coupling element (can be optionally ordered for the RLN22 NAMUR isolating amplifier), which is looped into the connection compartment of the FTE20 on the sensor side. This monitoring function is described in greater detail in the NE21 Recommendations (User Association of Automation Technology in Process Industries (NAMUR)).

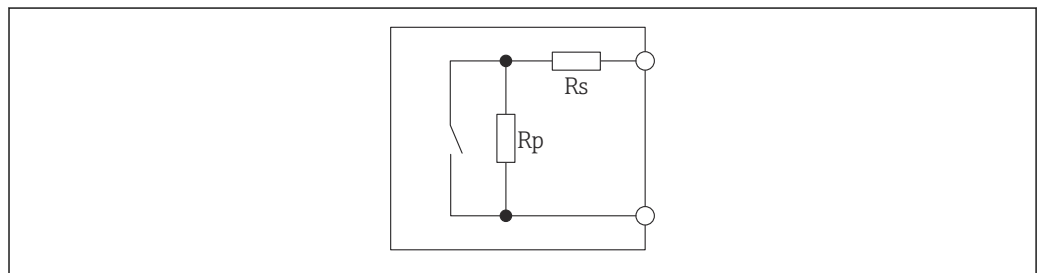

A0045584

22 Resistance circuit for line monitoring (short-circuit and line break)

R_s : 1 k Ω

R_p : 10 k Ω

13.2.4 RNO22 output isolating amplifier

Output isolating amplifiers are used to control I/P transducers, control valves and indicators. The device separates and transmits 0/4-20 mA signals. For operating the SMART actuators, the analog measuring value can be overlaid with digital HART communication signals and transmitted bidirectionally in an electrically isolated manner. The device enables open-circuit and short-circuit monitoring.

The following example shows a typical application of the RNO22 output isolating amplifier. The application is explained briefly and described in a schematic diagram.

Example: control valve activation in the hazardous area

- The active output of the control unit supplies an analog current signal to the passive input of the RNO22 output isolating amplifier
- The RNO22 supplies a 0/4-20 mA active current output signal, which is proportional to the input signal, and the HART signal to the control valve, which is controlled by the signal

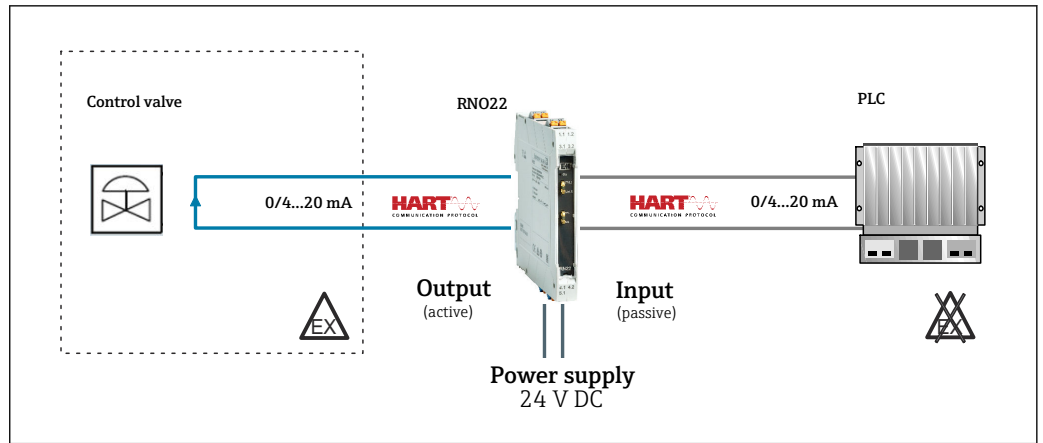

A0045585

23 Control valve activation in the hazardous area with an RNO22 output isolating amplifier

Index

A

- Accessories
 - Device-specific 27

C

- CE mark 6

D

- Declaration of Conformity 6
- Device documentation
 - Supplementary documentation 28
- Display and operating elements
 - Overview 15, 26
- Document
 - Function 3
- Document function 3

H

- Hardware settings
 - Configuration 15, 26

N

- Nameplate 8

O

- Operation options
 - Local operation 15, 26
- Operational safety 5

P

- Product safety 6

R

- Requirements for personnel 5
- Return 18

S

- Safety Instructions (XA) 28
- Short-circuit detection 15, 26

T

- Terminal assignment 13, 21
- Troubleshooting
 - General errors 17

W

- Workplace safety 5



www.addresses.endress.com
