

B44020

Accessories

Accessories for capacitors with mounting stud on capacitor base

Capacitor diameter	Dimensional drawing	Diameter d (mm)	Ordering code								
Insulating plastic shoulder washer "P" similar to DIN 41 331 specifications											
≤ 40 mm	<p>for M 8 thread</p>  <p>KAL0216-I</p>	8,4	B44020B0001B025								
> 40 mm	<p>for M 12 thread</p>  <p>KAL0059-P</p>	12,5	B44020B0002B030								
Insulating washer "N" made of laminated paper											
≤ 40 mm	<p>for M 8 / M 12 thread</p>  <p>KAL0066-7</p>	8,4	B44020A0001B025								
> 40 mm		13	B44020A0002B025								
Insulating washer made of Hostalen											
51,6 mm 76,9 mm	 <p>KAL0061-1</p>	<table border="1"> <tr> <td>$d_1 - 0,5$</td> <td>$d_2 - 0,5$</td> </tr> <tr> <td>51</td> <td>31</td> </tr> <tr> <td>76</td> <td>56</td> </tr> </table>	$d_1 - 0,5$	$d_2 - 0,5$	51	31	76	56	<table border="1"> <tr> <td>B44020B0006B051</td> </tr> <tr> <td>B44020B0006B076</td> </tr> </table>	B44020B0006B051	B44020B0006B076
$d_1 - 0,5$	$d_2 - 0,5$										
51	31										
76	56										
B44020B0006B051											
B44020B0006B076											

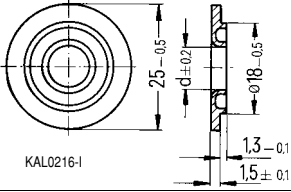
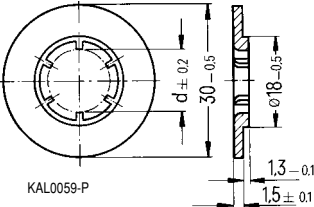
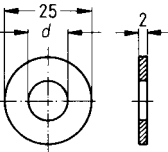
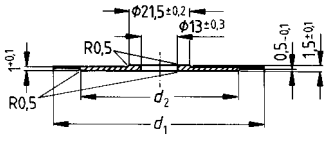
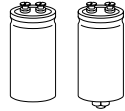

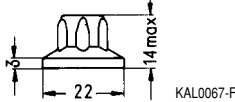
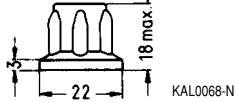
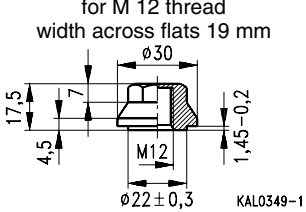
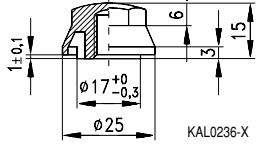
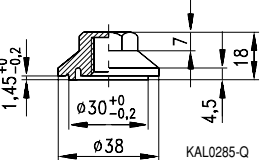
Capacitor diameter	Dimensional drawing	Ordering code
Plastic cap nut "V"		
≤ 40 mm	<p>for M 8 thread width across flats 13 mm</p> 	B44020B0005B008
> 40 mm	<p>for M 12 thread width across flats 17 mm</p> 	B44020A0005B012
Reinforced nylon cap nut		
> 40 mm	<p>for M 12 thread width across flats 19 mm</p> 	B44020J0006B012
≤ 40 mm	<p>for M 8 thread width across flats 17 mm</p> 	B44020J0006B008
> 40 mm	<p>for M 12 thread *) width across flats 19 mm</p> 	B44020J0007B012

*) For achieving larger clearances.

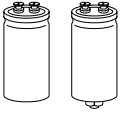

B44020

Accessories

Mounting instructions

Maximum tightening torques:

Thread	Maximum torque
M8	4 Nm
M12	10 Nm

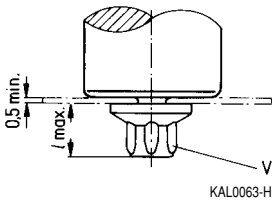

Non-insulated mounting
with cap nut

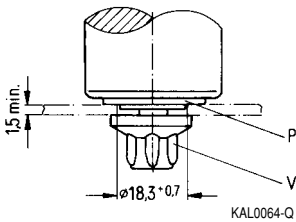

Mounting hole diameter

Insulated mounting
with cap nut

Insulated mounting with DIN 439 hex nut

$d \leq 76,9$ mm

$d = 91$ mm

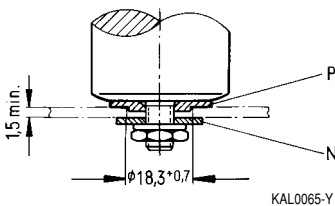

Mounting hole diameter

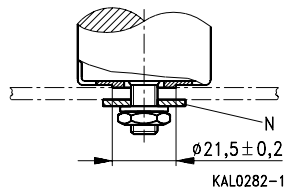

Mounting hole diameter

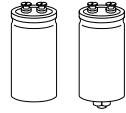

Ring clip mounting

Ring clips are primarily used for upright mounting of screw-terminal and photoflash capacitors. The clip surfaces are specially treated and corrosion-protected.

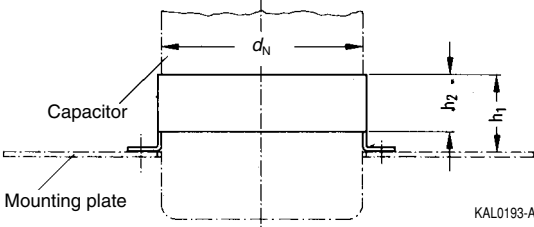

A variety of ring clip versions is available for Al electrolytic capacitors. Some versions are supplied with AM 3 × 10 DIN 84 clamping screws and DIN 934 nuts included. Additional insulation can be achieved by inserting a 30 mm-wide insulating strip between the capacitor and the ring clip. In such cases, attention must be paid to any relevant regulations (e. g. VDE, BSA or UL regulations).

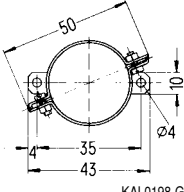
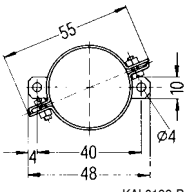
d_N	h_1	h_2	Ring clip version	Ordering code	
				without insulating strip	with insulating strip
25	19	15	 <p>KAL0198-G</p> <p>Clamping screws and nuts are included in delivery package.</p>	B44030A0025B	B44030J0025B (insulating strip length: 175mm)
30	19	15	 <p>KAL0199-P</p> <p>Clamping screws and nuts are included in delivery package.</p>	B44030A0030B	B44030J0030B (insulating strip length: 200mm)

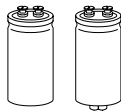

B44030

Accessories

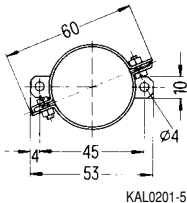
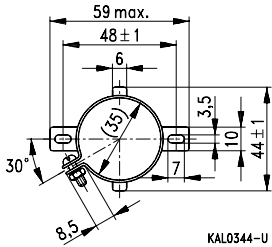
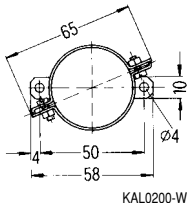
d_N	h_1 mm	h_2	Ring clip version	Ordering code without with insulating strip
35	19	15	 <p>KAL0201-5</p> <p>Clamping screws and nuts are included in delivery package.</p>	B44030A0035B B44030J0035B (insulating strip length: 230mm)
			 <p>KAL0344-U</p> <p>(insulating strip length: 230mm)</p>	B44030A0036B B44030J0036B (insulating strip length: 230mm)
40	19	15	 <p>KAL0200-W</p> <p>Clamping screws and nuts are included in delivery package.</p>	B44030A0040B B44030J0040B (insulating strip length: 260mm)

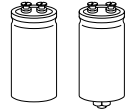

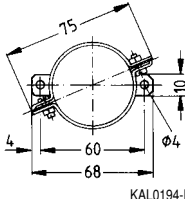
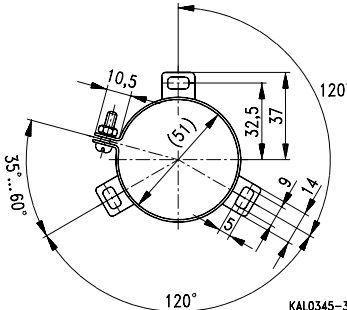
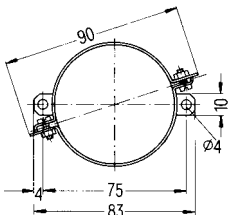
d_N	h_1 mm	h_2	Ring clip version	Ordering code without insulating strip	with insulating strip
50	19	15	 <p>KAL0194-1</p> <p>Clamping screws and nuts are included in delivery package.</p>	B44030A0050B	B44030J0050B (insulating strip length: 325 mm)
	22	15	 <p>KAL0345-3</p> <p>(insulating strip length: 325 mm)</p>	B44030A0051B	B44030J0051B (insulating strip length: 325 mm)
65	26	22	 <p>KAL0203-L</p> <p>Clamping screws and nuts are included in delivery package.</p>	B44030A0065B	B44030J0065B (insulating strip length: 420 mm)

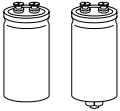

B44030

Accessories

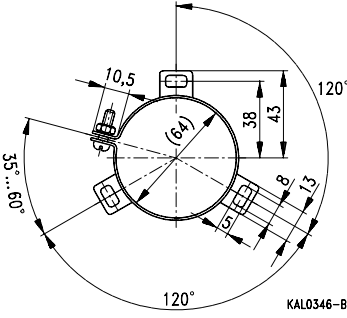
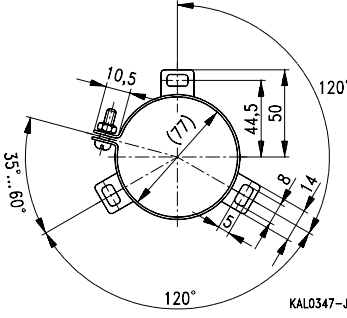
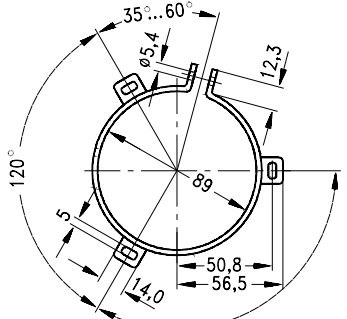
d_N	h_1 mm	h_2	Ring clip version	Ordering code without insulating strip	with insulating strip
65	29	19		B44030A0064B	B44030J0064B (insulating strip length: 420mm)
75	29	19		B44030A0075B	B44030J0075B (insulating strip length: 495mm)
90	29	19		B44030A0090B	B44030J0090B (insulating strip length: 585mm)

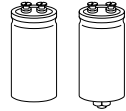

Clamp mounting

Screw-terminal capacitors without threaded stud and with a diameter $\geq 64,3$ mm can also be mounted with clamps.

Clamp mounting offers the following advantages:

- Optimum heat transfer between capacitor base and board due to pressure contact
- High vibration resistance
- Electrically insulated material

Dimensional drawing

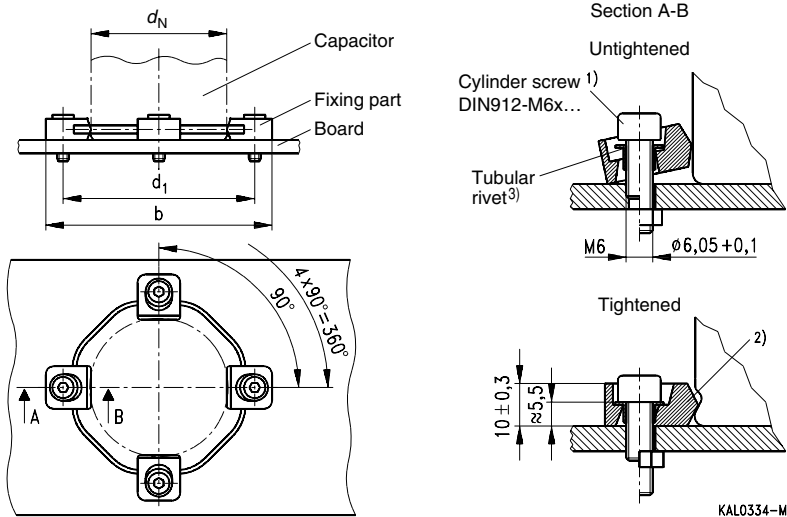

Dimensions and ordering codes

Capacitor diameter d_N	$d_1 \pm 0,2$ mm	b mm	Ordering code
65 mm	87	104	B44030A0165B
75 mm	99	116	B44030A0175B
90 mm	112	130	B44030A0190B

Screws are not included in the delivery package.

1) Length depends on application.

2) The screws have to be tightened uniformly and crosswise until the fixing part rests flatly on the board.

3) Tubular rivets included in delivery package.

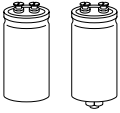

B44030

Accessories

Mounting set (clamping rings)

This mounting set offers following advantages:

- Protects the capacitor against tilt
- Fits for different capacitor length
- Protects the capacitor terminals from mechanical stress
- Electrically insulated clamping material

Dimensional drawing

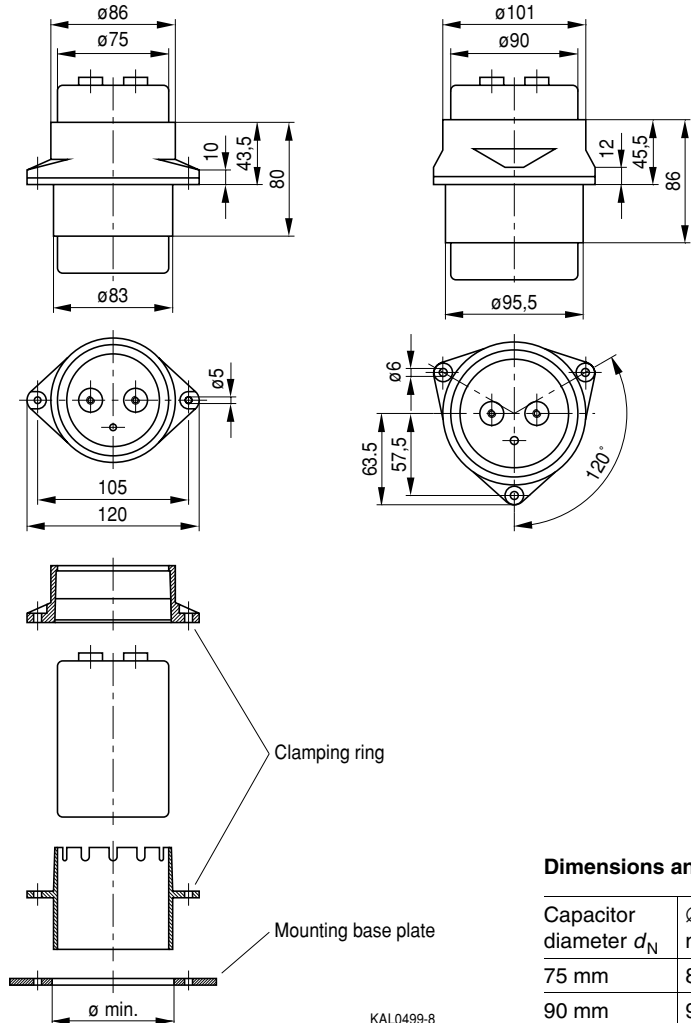

KAL0499-8

Dimensions and ordering codes

Capacitor diameter d_N	\varnothing_{min} mm	Ordering code
75 mm	84	B44030A0375B
90 mm	96,5	B44030A0390B

Herausgegeben von EPCOS AG

Unternehmenskommunikation, Postfach 80 17 09, 81617 München, DEUTSCHLAND

☎ ++49 89 636 09, FAX (0 89) 636-2 26 89

© EPCOS AG 2002. Vervielfältigung, Veröffentlichung, Verbreitung und Verwertung dieser Broschüre und ihres Inhalts ohne ausdrückliche Genehmigung der EPCOS AG nicht gestattet.

Bestellungen unterliegen den vom ZVEI empfohlenen Allgemeinen Lieferbedingungen für Erzeugnisse und Leistungen der Elektroindustrie, soweit nichts anderes vereinbart wird.

Diese Broschüre ersetzt die vorige Ausgabe.

Fragen über Technik, Preise und Liefermöglichkeiten richten Sie bitte an den Ihnen nächstgelegenen Vertrieb der EPCOS AG oder an unsere Vertriebsgesellschaften im Ausland. Bauelemente können aufgrund technischer Erfordernisse Gefahrstoffe enthalten. Auskünfte darüber bitten wir unter Angabe des betreffenden Typs ebenfalls über die zuständige Vertriebsgesellschaft einzuholen.

Published by EPCOS AG

Corporate Communications, P.O. Box 80 17 09, 81617 Munich, GERMANY

☎ ++49 89 636 09, FAX (0 89) 636-2 26 89

© EPCOS AG 2002. Reproduction, publication and dissemination of this brochure and the information contained therein without EPCOS' prior express consent is prohibited.

Purchase orders are subject to the General Conditions for the Supply of Products and Services of the Electrical and Electronics Industry recommended by the ZVEI (German Electrical and Electronic Manufacturers' Association), unless otherwise agreed.

This brochure replaces the previous edition.

For questions on technology, prices and delivery please contact the Sales Offices of EPCOS AG or the international Representatives.

Due to technical requirements components may contain dangerous substances. For information on the type in question please also contact one of our Sales Offices.