

# 92x92x25 mm (IP Series)

65.0~75.0 CFM



■ Specifications

IP56 Model	Bearing	Rating Voltage	Power Current	Power Consumption	Speed	Air Flow	Static Pressure	Noise	Weight	Curve
	2BALL Sleeve	(VDC)	(mA)	(WATTS)	(RPM)	(CFM)	(Inch-H <sub>2</sub> O)	(dB(A))	(g)	
GF92251B1-000U-AC9	☉	12	393	4.72	4500	75.0	0.35	47.0	113.0	1
GF92251B2-000U-AC9	☉	12	300	3.60	4200	70.0	0.30	45.0	113.0	2
GF92251B3-000U-AC9	☉	12	230	2.76	3900	65.0	0.25	43.0	113.0	3
GE92252B1-000U-AC9	☉	24	220	5.28	4500	75.0	0.35	47.0	113.0	1
GE92252B2-000U-AC9	☉	24	180	4.32	4200	70.0	0.30	45.0	113.0	2
GE92252B3-000U-AC9	☉	24	155	3.72	3900	65.0	0.25	43.0	113.0	3
GE92254B1-000U-AC9	☉	48	125	6.00	4500	75.0	0.35	47.0	113.0	1
GE92254B2-000U-AC9	☉	48	108	5.19	4200	70.0	0.30	45.0	113.0	2
GE92254B3-000U-AC9	☉	48	85	4.08	3900	65.0	0.25	43.0	113.0	3

IP68 Model	Bearing	Rating Voltage	Power Current	Power Consumption	Speed	Air Flow	Static Pressure	Noise	Weight	Curve
	2BALL Sleeve	(VDC)	(mA)	(WATTS)	(RPM)	(CFM)	(Inch-H <sub>2</sub> O)	(dB(A))	(g)	
GF92251B1-000U-AE9	☉	12	393	4.72	4500	75.0	0.35	47.0	113.0	1
GF92251B2-000U-AE9	☉	12	300	3.60	4200	70.0	0.30	45.0	113.0	2
GF92251B3-000U-AE9	☉	12	230	2.76	3900	65.0	0.25	43.0	113.0	3
GE92252B1-000U-AE9	☉	24	220	5.28	4500	75.0	0.35	47.0	113.0	1
GE92252B2-000U-AE9	☉	24	180	4.32	4200	70.0	0.30	45.0	113.0	2
GE92252B3-000U-AE9	☉	24	155	3.72	3900	65.0	0.25	43.0	113.0	3
GE92254B1-000U-AE9	☉	48	125	6.00	4500	75.0	0.35	47.0	113.0	1
GE92254B2-000U-AE9	☉	48	108	5.19	4200	70.0	0.30	45.0	113.0	2
GE92254B3-000U-AE9	☉	48	85	4.08	3900	65.0	0.25	43.0	113.0	3

■ Air Flow-Static Pressure Characteristics

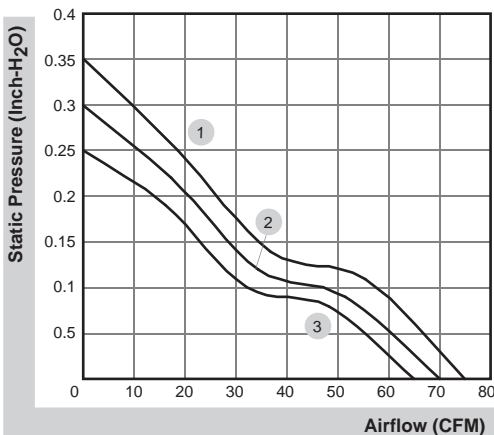

■ External dimensions(mm)

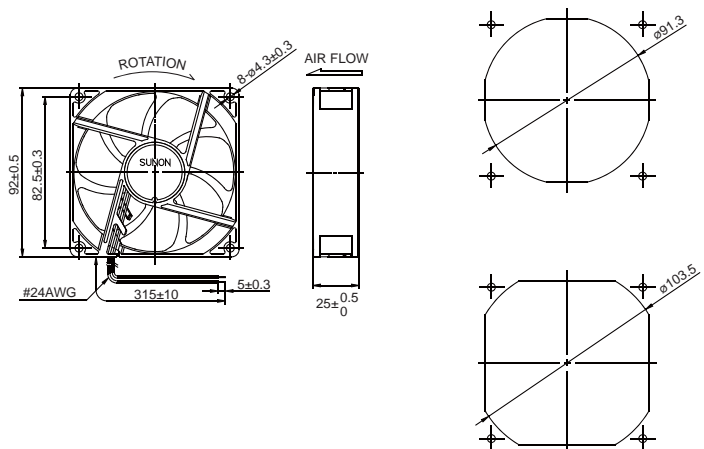

\*All model could be customized. Please contact with Sunon Sales.

\*Specifications are subject to change without notice. Please Visit SUNON website at [www.sunon.com](http://www.sunon.com) for update information.