

Index Plungers Mini Indexes · basic type

22110.0628



Product Description

Particularly suitable for screwing into thin walled pieces.
Performance in the smallest space requirements.
Due to a thread recess the index plungers can be completely screwed in.

Material

Body

- Steel, zinc-plated by galvanization

Locking pin

- Stainless steel 1.4305

Knob

- Thermoplastic PA 6, black, dull

Assembly

Screw in the mini index. By lifting the knob, the hexagon will be released for assembly.
The screw length can be adapted by distance collars for index plungers (EH 22120.).

Operation

When using the self-locking type the knob is pulled-out, turned 30° and secured by a notched catch.

More information

Notes

Knob not removable.

Further products

- Distance Collars, for index plungers

Drawing

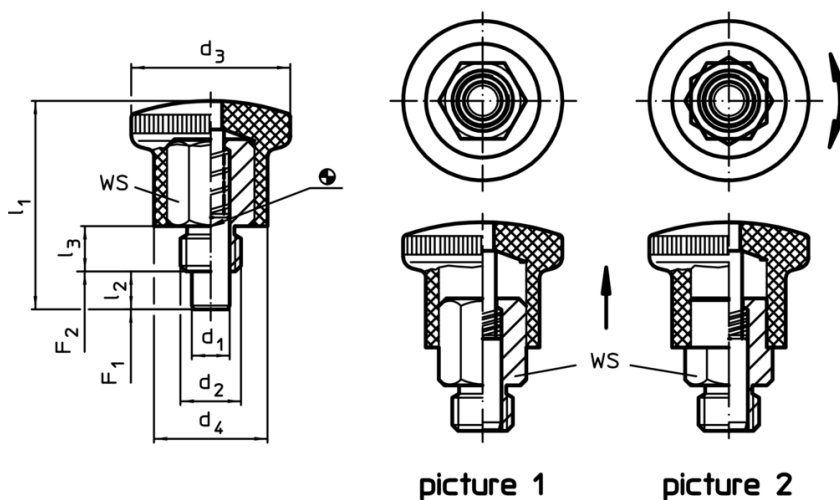

Order information

Dimensions							WS	Spring load ¹⁾		Temperature		Weight	Art. No.
d ₁ h9	d ₂	d ₃	d ₄	l ₁	l ₂ min.	l ₃		F ₁ ~	F ₂ ~	min.	max.		
[mm]							[mm]	[N]		[°C]			
without locking – picture 1, steel													
10	M16 x 1,5	33	23	47.5	10	12	17	11	35	-30	80	69	22110.0628

¹⁾ statistical average value

Application example

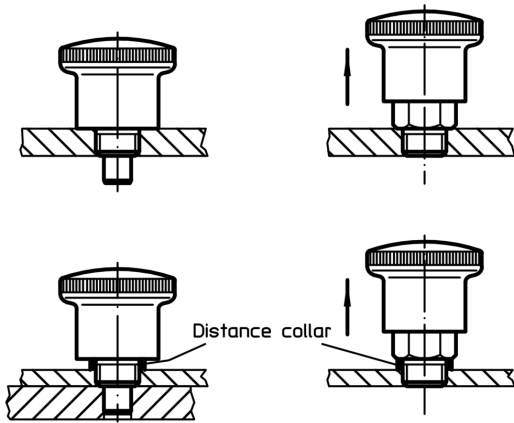

Compliance

RoHS compliant

Contains lead - compliant according to exceptions 6a / 6b / 6c

Contains SVHC substances >0,1% w/w

Contains lead - SVHC list [REACH] as of 10.06.2022

Contains Proposition 65 substances



Lead can cause cancer and reproductive harm from exposure
<https://www.P65Warnings.ca.gov/>

Free from Conflict Minerals

This product does not contain any substances designated as "conflict minerals" such as tantalum, tin, gold or tungsten from the Democratic Republic of Congo or adjacent countries.