

MAX149X1 Evaluation Kit

**Evaluates: MAX14938/MAX14939/
MAX14941/MAX14942/
MAX14945/MAX14948**

General Description

The MAX149X1 evaluation kit (EV kit) is a fully assembled and tested PCB that demonstrates the functionality of the MAX14938 isolated RS-485/Profibus™ transceiver. The EV kit operates from a single 3.3V supply and features an on-board isolated power supply to power the secondary-side of the circuit.

The MAX149X1 EV kit can also be used to evaluate the MAX14939, MAX14941, MAX14942, MAX14945, and MAX14948.

Features

- Operates From a Single 3.3V Supply
- Terminal Block Connectors for Easy RS-485/Profibus Evaluation
- 2750V_{RMS} Isolation for 60s
- Fully Assembled and Tested

Quick Start

Required Equipment

- MAX149X1 EV kit
- 3.3V, 1A DC power supply
- Signal/function generator
- Oscilloscope

[Ordering Information](#) appears at end of data sheet.

Startup Procedure

The EV kit is fully assembled and tested. Follow the steps below to verify board operation.

- 1) Set the DC power supply to 3.3V and connect the DC power supply between the EV kits V_{DDA} and G_{NDA} connectors.
- 2) Ensure that all jumpers are in their default positions (see [Table 1](#)).
- 3) Turn on the power supply.
- 4) Set the signal/function generator to output a 100kHz 0-to-3V square wave. *NOTE: Set the signal/function generator to operate with a high-impedance load. If needed, the R1 pad is available to add a 50Ω impedance to ground.*
- 5) Connect the signal/function generator to the TXD test point.
- 6) Using the oscilloscope, verify that the A and B outputs switch as the signal toggles.

The PROFIBUS-DP logo is a registered trademark of PROFIBUS and PROFINET International (PI).



MAX149X1 Evaluation Kit

Evaluates: MAX14938/MAX14939/
MAX14941/MAX14942/
MAX14945/MAX14948

Detailed Description of Hardware

The EV kit is a fully assembled and tested circuit board for evaluating the MAX14938 isolated RS-485/Profibus transceiver (U2). The EV kit has been designed to allow for evaluating the MAX14938 alone or in a standard RS-485 configuration. The EV kit is powered from a single 3.3V power supply.

Powering the Board

The power on the EV kit is derived from a single 3.3V source. Connect an external supply from GNDA to either the V_{DDA} test point or P1 connector to supply the 3.3V to the logic-side (A) of the circuit.

An on-board MAX258 transformer driver (U1) and external transformer (TX1) generate an isolated supply for powering the (B) isolated-side of the board. To disable the MAX258 circuit, connect jumper J1 to 2-3. To disconnect the output of the transformer circuit from the MAX14938 LDO input, remove the shunt on J5.

Evaluating the Isolated RS-485 Interface

Driver and Receiver Enable Selection

The EV kit features three jumpers (J2, J3, and J4) to enable/disable the driver and receiver outputs. Set J2 to 2-3 to enable the receiver. Set J3 to 1-2 to enable the driver. To actively control both enables, open J2 and J3 and close J4, which connects DE and \overline{RE} together.

Resistors R2–R4 Configuration

For end-of-the-line transceivers, close J6 to connect a 120Ω resistor (R3) between the A and B RS-485 I/Os on the MAX14938.

Pullup and pulldown resistors are generally used on the receiver inputs to guarantee a known state in the event that all nodes on the bus are in receive mode, or the cable becomes disconnected. The exact value for these resistors will vary with the application. Pads are provided for pullup (R2) and pulldown (R4) resistors for the A-B lines, although the use of these resistors is purely optional. Note that the MAX14938 features true fail-safe receiver inputs, which ensures that RXD is high when the receiver inputs are shorted, open, or connected to an idle bus.

Table 1. Jumper Table (J1–J6)

JUMPER	SHUNT POSITION	DESCRIPTION
J1	1-2	MAX258 transformer driver is disabled.
	2-3*	MAX258 transformer driver is enabled.
J2	1-2*	\overline{RE} is high. The RS-485 receiver is disabled.
	2-3	\overline{RE} is low. The RS-485 receiver is enabled.
J3	1-2*	DE is high. The RS-485 driver outputs are enabled.
	2-3	DE is low. The RS-485 driver outputs are disabled.
J4	Open*	DE and \overline{RE} are not connected together.
	Closed	DE and \overline{RE} are connected together.
J5	Open	Output of the transformer circuit is not connected to VLDO.
	Closed*	Output of the transformer circuit is connected to VLDO and powers the B-side of the MAX14938.

*Default position.

MAX149X1 Evaluation Kit

Evaluates: MAX14938/MAX14939/
MAX14941/MAX14942/
MAX14945/MAX14948

Ordering Information

PART	TYPE
MAX149X1EVKIT#	EV Kit

#Denotes RoHS compliant.

MAX149X1 Evaluation Kit

Evaluates: MAX14938/MAX14939/
MAX14941/MAX14942/
MAX14945/MAX14948

MAX149X1 Bill of Materials

ITEM	REF_DES	DNI	QTY	MFG PART #	MANUFACTURER	VALUE	DESCRIPTION	COMMENTS
1	C1, C3, C6, C8	-	4	GRM188R71E105KA12D; CGA3E1X7R1E105K	MURATA	1UF	CAPACITOR; SMT (0603); CERAMIC CHIP; 1UF; 25V; TOL=10%; MODEL=GRM SERIES; TG=-55 DEGC TO +125 DEGC; TC=X7R	
2	C2, C7	-	2	C0603C104K4RAC; GCM188R71C104KA37; C1608X7R1C104K; GRM188R71C104K; C0603X7R160-104KNE	KEMET/MURATA/TDK/ VENKEL LTD.	0.1UF	CAPACITOR; SMT (0603); CERAMIC CHIP; 0.1UF; 16V; TOL=10%; TG=-55 DEGC TO +125 DEGC; TC=X7R;	
3	C4, C9	-	2	GRM21BR61E106K; C2012X5R1E106K125AB; C2012X5R1E106K	MURATA/TDK	10UF	CAPACITOR; SMT (0805); CERAMIC CHIP; 10UF; 25V; TOL=10%; MODEL=; TG=-55 DEGC TO +125 DEGC; TC=X5R	
4	C5	-	1	C0603C104K3RAC; GRM188R71E104KA01; C1608X7R1E104K	KEMET/MURATA/TDK	0.1UF	CAPACITOR; SMT; 0603; CERAMIC; 0.1uF; 25V; 10%; X7R; -55degC to +125degC; +/-15% from -55degC to +125degC;	
5	D1, D2	-	2	MBR0520	GENERIC PART	MBR0520	DIODE; SCH; SCHOTTKY RECTIFIER; SMT (SOD-123); PIV=20V; IF=0.5A; -55 DEGC TO +150 DEGC	
6	J1-J3	-	3	PEC03SAAN	SULLINS	PEC03SAAN	CONNECTOR; MALE; THROUGH HOLE; BREAKAWAY; STRAIGHT; 3PINS	
7	J4-J6	-	3	PEC02SAAN	SULLINS	PEC02SAAN	CONNECTOR; MALE; THROUGH HOLE; BREAKAWAY; STRAIGHT; 2PINS	
8	P1	-	1	1935161	PHOENIX CONTACT	1935161	CONNECTOR; FEMALE; THROUGH HOLE; GREEN TERMINAL BLOCK; STRAIGHT; 2PINS	
9	P2, P3	-	2	1935200	PHOENIX CONTACT	1935200	CONNECTOR; FEMALE; THROUGH HOLE; GREEN TERMINAL BLOCK; STRAIGHT; 6PINS	
10	R3	-	1	CRCW0603120RJN	VISHAY DALE	120	RESISTOR; 0603; 120 OHM; 5%; 200PPM; 0.10W; THICK FILM	
11	SU1-SU4	-	4	STC02SYAN	SULLINS ELECTRONICS CORP.	STC02SYAN	TEST POINT; JUMPER; STR; TOTAL LENGTH=0.256IN; BLACK; INSULATION=PBT CONTACT=PHOSPHOR BRONZE; COPPER PLATED TIN OVERALL	
12	T1, T9, T10	-	3	5010	?	5010	TESTPOINT WITH 1.80MM HOLE DIA, RED, MULTIPURPOSE	
13	T2-T6, T11-T13	-	8	5014	?	5014	TEST POINT; PIN DIA=0.125IN; TOTAL LENGTH=0.445IN; BOARD HOLE=0.063IN; YELLOW; PHOSPHOR BRONZE WIRE SILVER PLATE FINISH;	
14	T7, T8, T14, T15	-	4	5011	?	5011	TEST POINT; PIN DIA=0.125IN; TOTAL LENGTH=0.445IN; BOARD HOLE=0.063IN; BLACK; PHOSPHOR BRONZE WIRE SILVER PLATE FINISH;	
15	TX1	-	1	TGMS-1464V6LF	HALO ELECTRONICS, INC	TGMS-1464V6LF	TRANSFORMER; SMT; 1:2.4; POWER TRANSFORMER; DRAFT DATASHEET ONLY	
16	U1	-	1	MAX258ATA+	MAXIM	MAX258ATA+	IC; DRV; 0.5A; PUSH-PULL TRANSFORMER DRIVER FOR ISOLATED POWER SUPPLY; TDFN8-EP 2X3	
17	U2	-	1	MAX14938GWE+	MAXIM	MAX14938	EVKIT PART-IC; PACKAGE CODE: W16M+10; OUTLINE DRAWING NO.: 21-0042; LAND PATTERN DRAWING NO.: 90-0107; WSOIC16 300MIL	
18	R1, R2, R4	DNP	3	N/A	N/A	OPEN	PACKAGE OUTLINE 0603 RESISTOR - EVKIT	

MAX149X1 Evaluation Kit

Evaluates: MAX14938/MAX14939/
MAX14941/MAX14942/
MAX14945/MAX14948

MAX149X1 Schematics

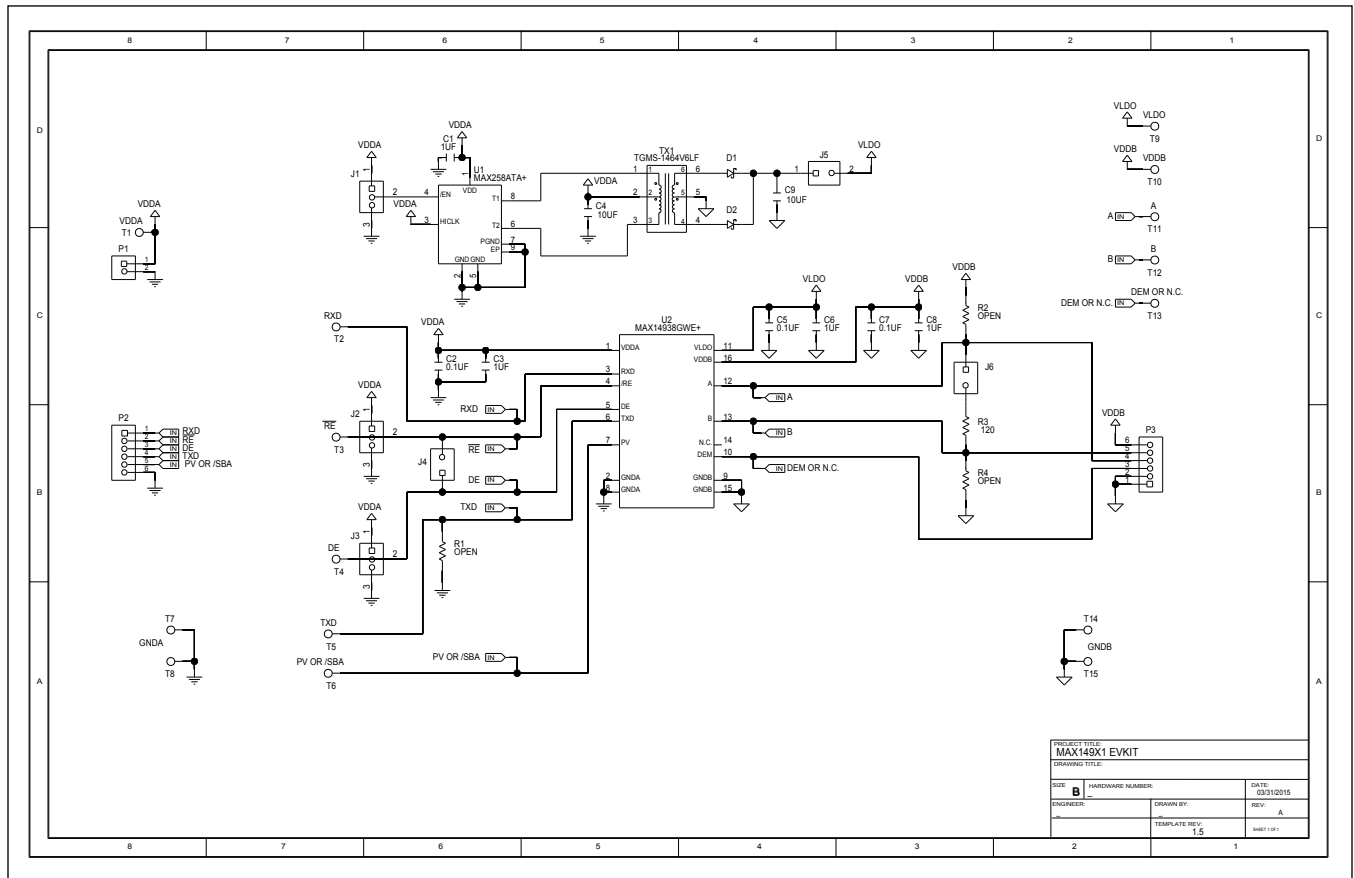

MAX149X1 PCB Layout

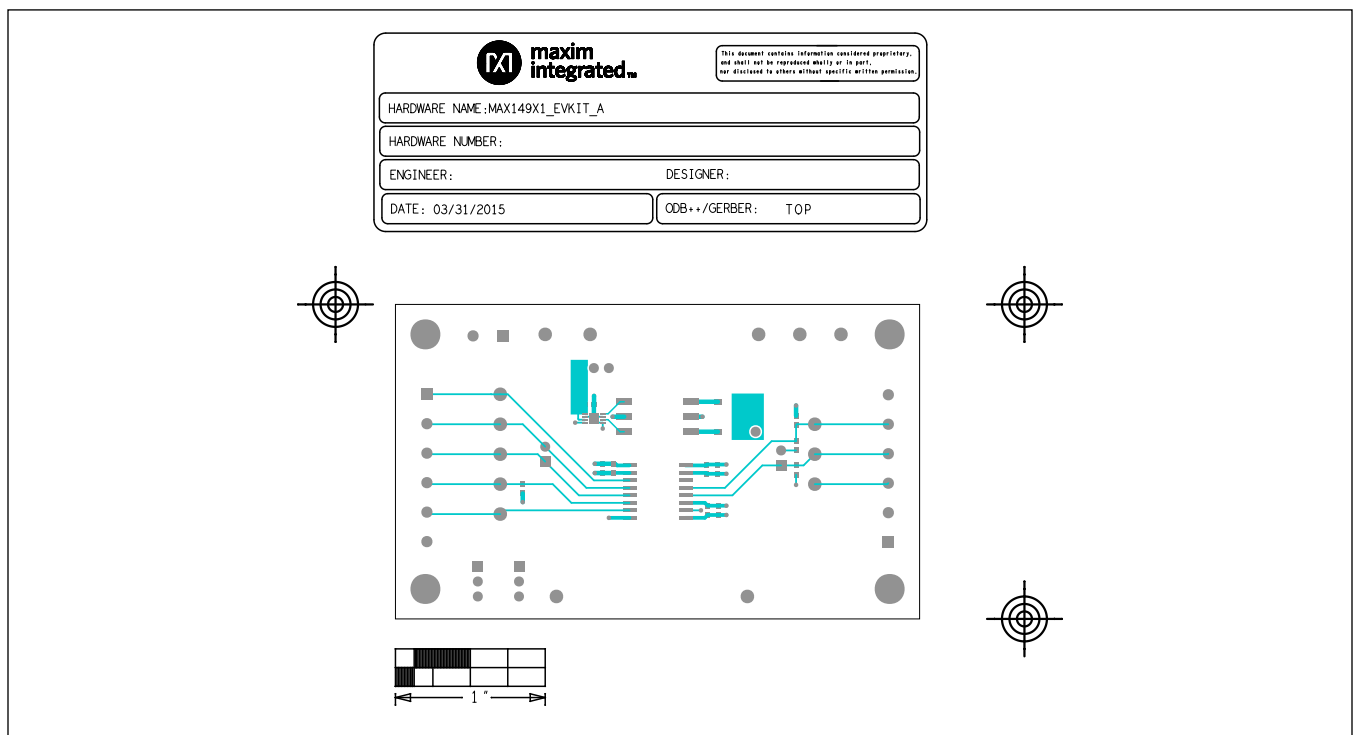
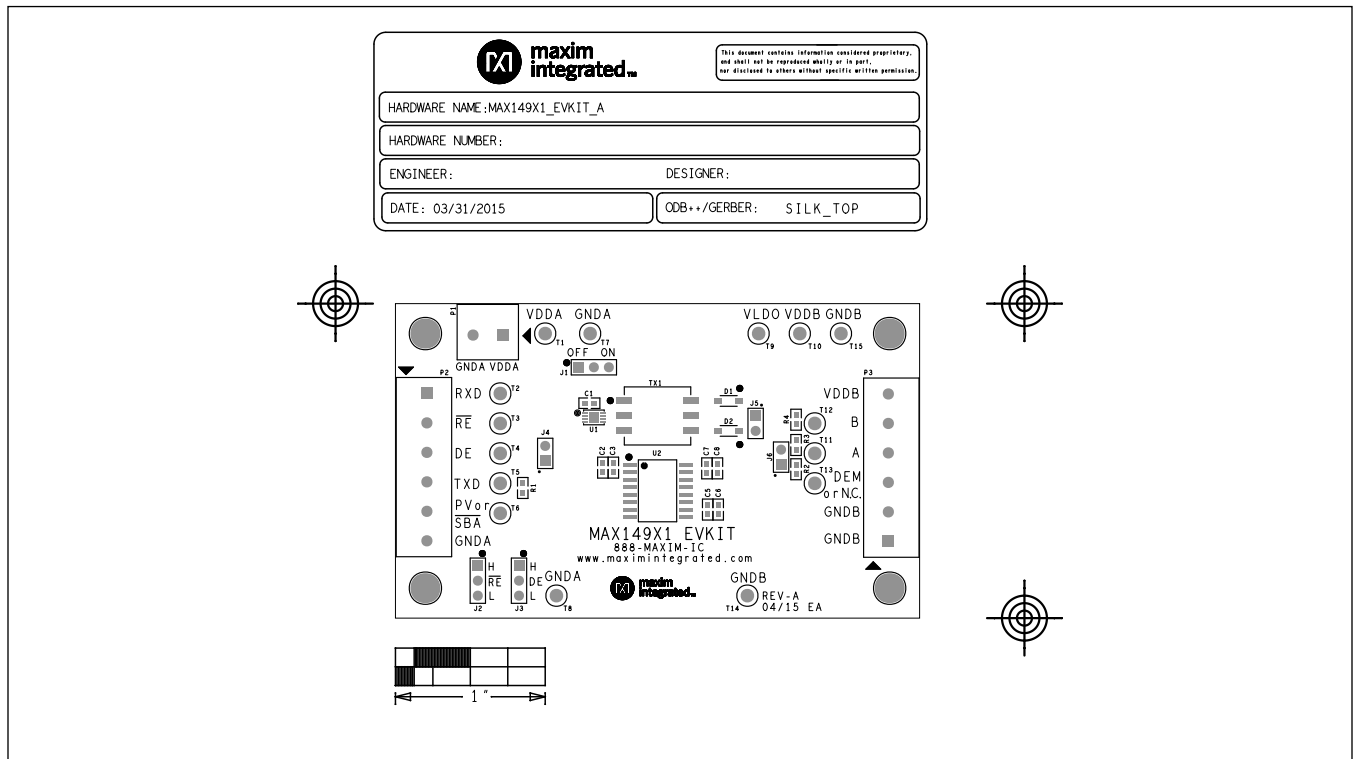

MAX149X1 PCB Layout (continued)

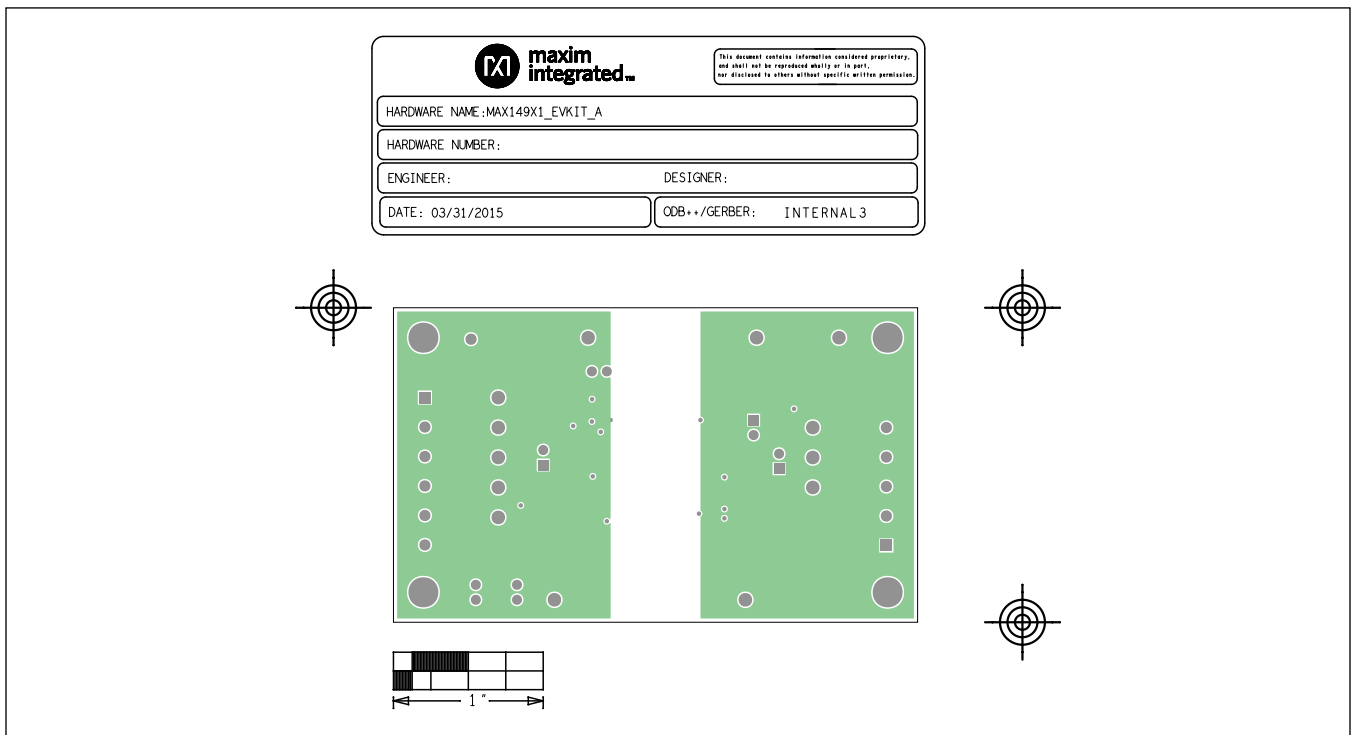
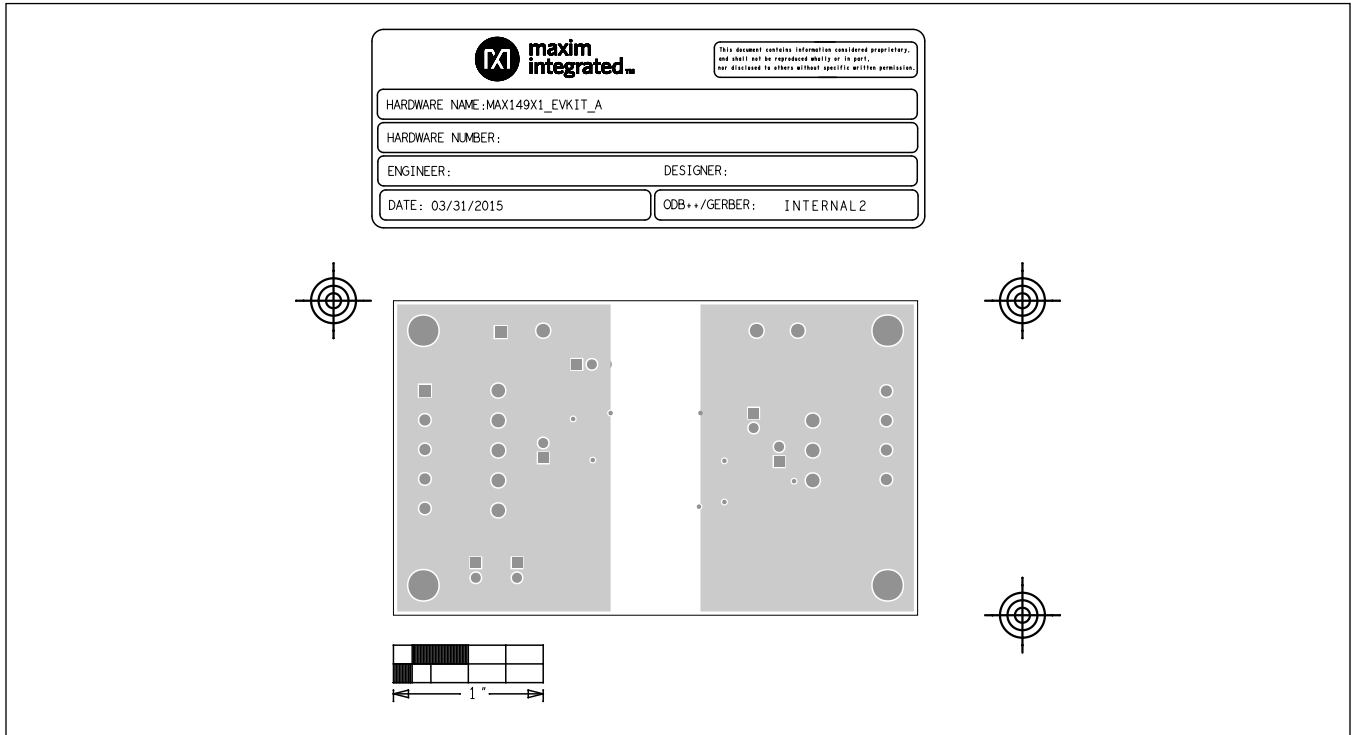

MAX149X1 PCB Layout (continued)

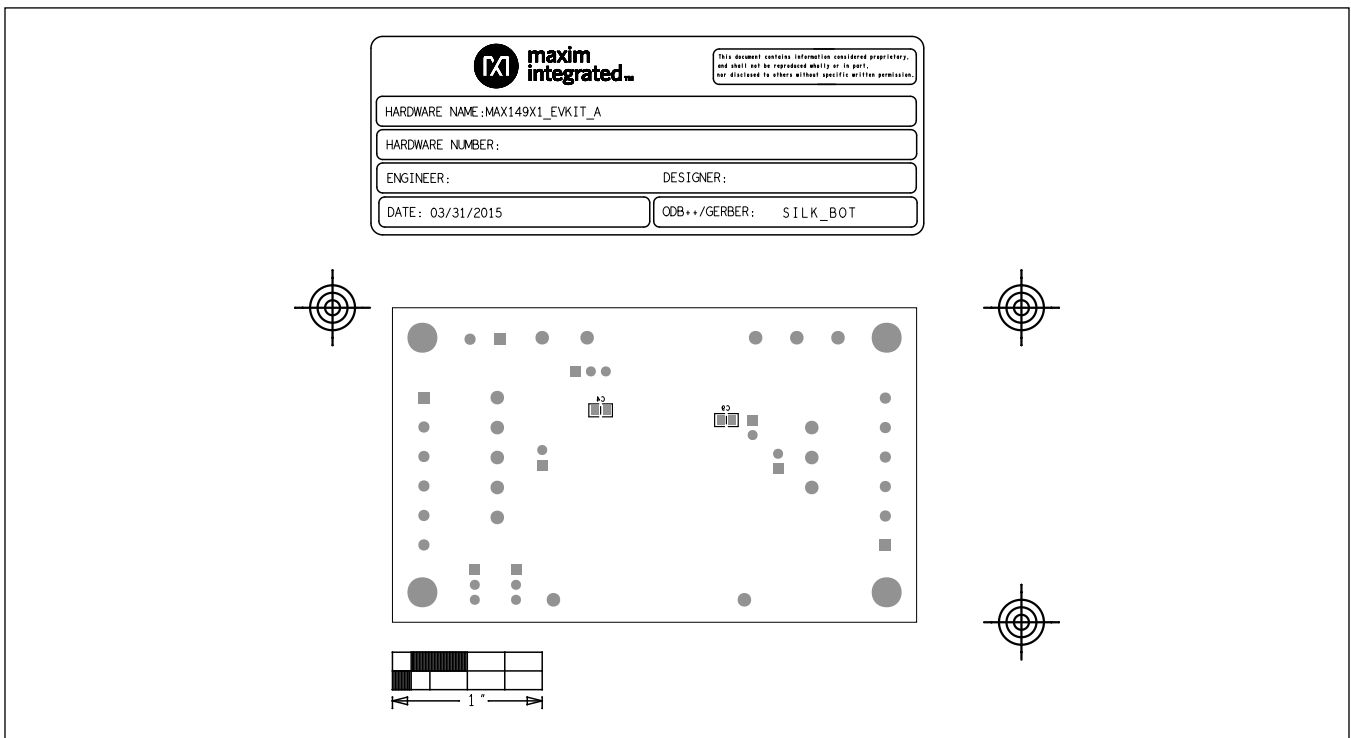
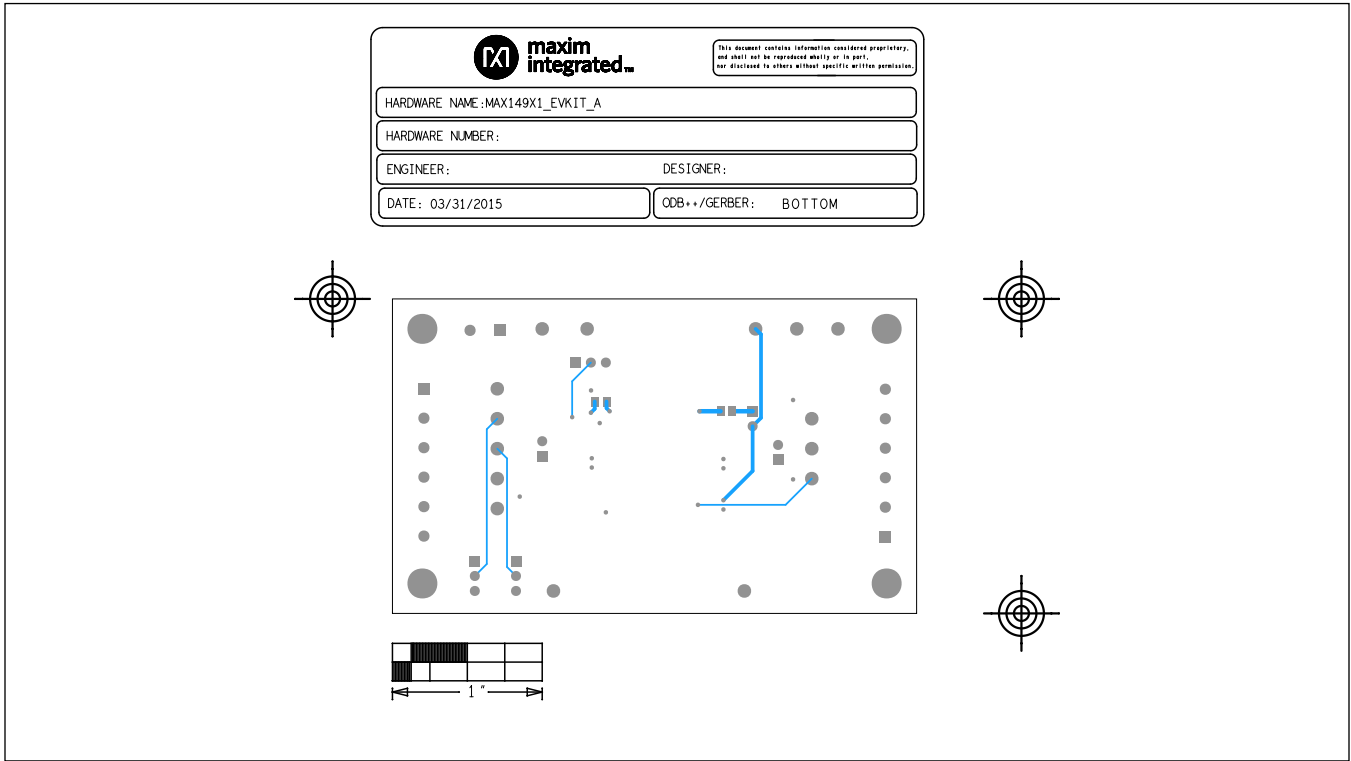

MAX149X1 Evaluation Kit

Evaluates: MAX14938/MAX14939/
MAX14941/MAX14942/
MAX14945/MAX14948

Revision History

REVISION NUMBER	REVISION DATE	DESCRIPTION	PAGES CHANGED
0	2/16	Initial release	—
1	7/16	Added MAX14939 and MAX14948	1-9

For pricing, delivery, and ordering information, please contact Maxim Direct at 1-888-629-4642, or visit Maxim Integrated's website at www.maximintegrated.com.

Maxim Integrated cannot assume responsibility for use of any circuitry other than circuitry entirely embodied in a Maxim Integrated product. No circuit patent licenses are implied. Maxim Integrated reserves the right to change the circuitry and specifications without notice at any time.