

LQH2HNNH220J03#

“#” indicates a package specification code.

It can be used in 125 °C environment.



< List of part numbers with package codes >
LQH2HNNH220J03L

Appearance & Shape

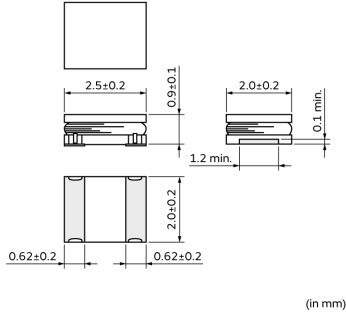

References

Packaging	Specifications	Standard Packing Quantity
L	180Embossed Tape	3000
Mass (typ.)		
1 piece		0.019g

Notices

Please consider 'Notice (Rating).

Attention

- 1.This datasheet is downloaded from the website of Murata Manufacturing Co., Ltd. Therefore, it's specifications are subject to change or our products in it may be discontinued without advance notice. Please check with our sales representatives or product engineers before ordering.
- 2.This datasheet has only typical specifications because there is no space for detailed specifications. Therefore, please review our product specifications or consult the approval sheet for product specifications before ordering.

LQH2HNNH220J03#

“#” indicates a package specification code.



Specifications

L size	2.5±0.2mm
W size	2.0±0.2mm
T size	0.9±0.1mm
Size code inch (mm)	1008 (2520)
Inductance	22μH±5%
Inductance Test Frequency	1MHz
Rated current (Itemp) (Based on Temperature rise)	95mA(Ambient temp.85°C) 85mA(Ambient temp.125°C)
Max. of DC resistance	3.3Ω
Class of magnetic shield	Ferrite Core
Self resonance frequency (min.)	21MHz
Brand	Murata
DC Resistance Intermediate Values	2.75Ω±20%
Operating Temperature Range	-40°C to 125°C
Series	LQH2HNNH_03

Attention

1.This datasheet is downloaded from the website of Murata Manufacturing Co., Ltd. Therefore, it's specifications are subject to change or our products in it may be discontinued without advance notice. Please check with our sales representatives or product engineers before ordering.

2.This datasheet has only typical specifications because there is no space for detailed specifications.

Therefore, please review our product specifications or consult the approval sheet for product specifications before ordering.

LQH2HNNH220J03#

“#” indicates a package specification code.



Notice For General

In operating temperatures exceeding +85°C, derating of current is necessary for this series.

Please apply the derating curve shown in the chart according to the operating temperature.

Derating of Rated Current

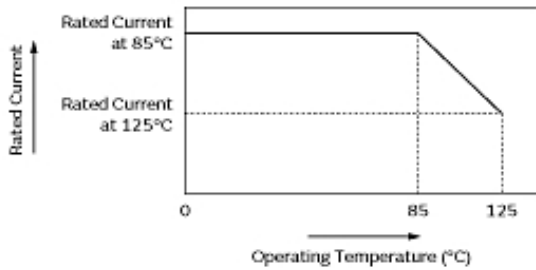

Attention

1.This datasheet is downloaded from the website of Murata Manufacturing Co., Ltd. Therefore, it's specifications are subject to change or our products in it may be discontinued without advance notice. Please check with our sales representatives or product engineers before ordering.

2.This datasheet has only typical specifications because there is no space for detailed specifications.

Therefore, please review our product specifications or consult the approval sheet for product specifications before ordering.