

MOTOR SOLUTIONS

User-Friendly Motor Control Development Environment
to Shorten Time to Market



RENESAS MOTOR SOLUTIONS FOR A GREENER SOCIETY

Renesas offers semiconductor products with low environmental impact throughout their life cycle in the interest of coexistence with the planet and harmony between humankind and the environment.



As the scope of motor applications has broadened in recent years, Renesas semiconductor devices for motors have come to be used in a wide variety of fields. Renesas provides customers with optimal motor solutions to help realize a greener society.

CONTENT

Motor Solution of Renesas _____	03	Motor Control Development Support Tool _____	14
Motor Type, Sensor Features _____	04	RAA227063 3-Phase Smart Gate Drivers _____	16
Motor Control Methods, Sensors _____	05	Related Devices _____	17
Motor Solution Lineup _____	06	MCUs and MPUs _____	17
Solutions of Each Motor _____	07	Motor Sensor Processing IC, Motor Control IC _____	18
Solutions for Permanent Magnet Synchronous Motor _____	07	Power Management _____	19
Solutions for Stepping Motor _____	10	Power Device, Others _____	20
Solutions for AC Induction Motor _____	12		
Solution for Magnetic Sensor _____	12		
Solution for Inductive Position Sensor _____	13		

Powerful Support for Customers' Development Efforts Motor Solutions

Basic Motor Control Configuration

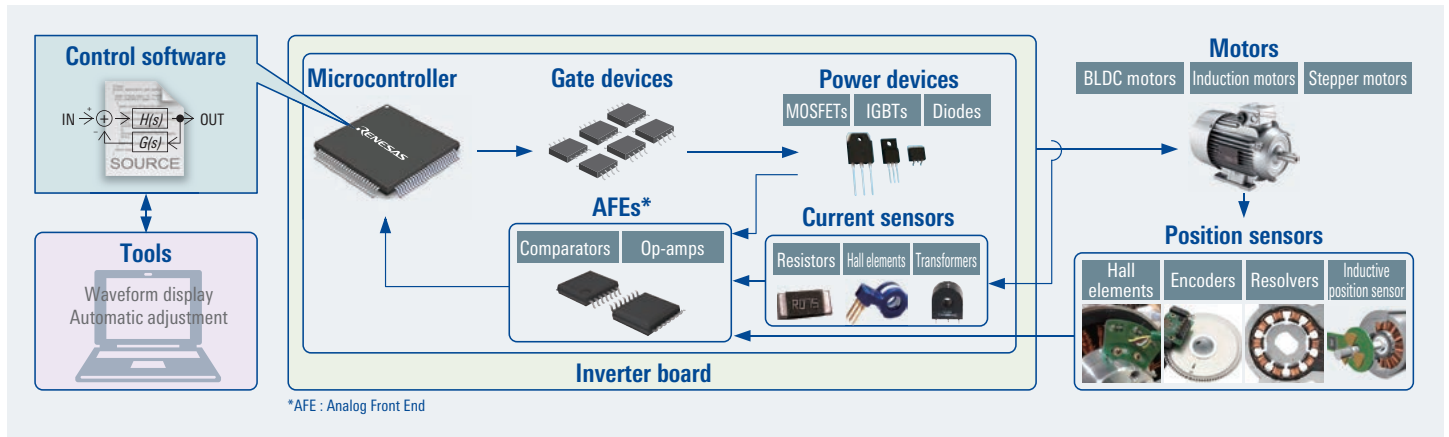

Motor Solution Classification

Renesas motor solutions are comprised of devices, hardware, software, and tools.

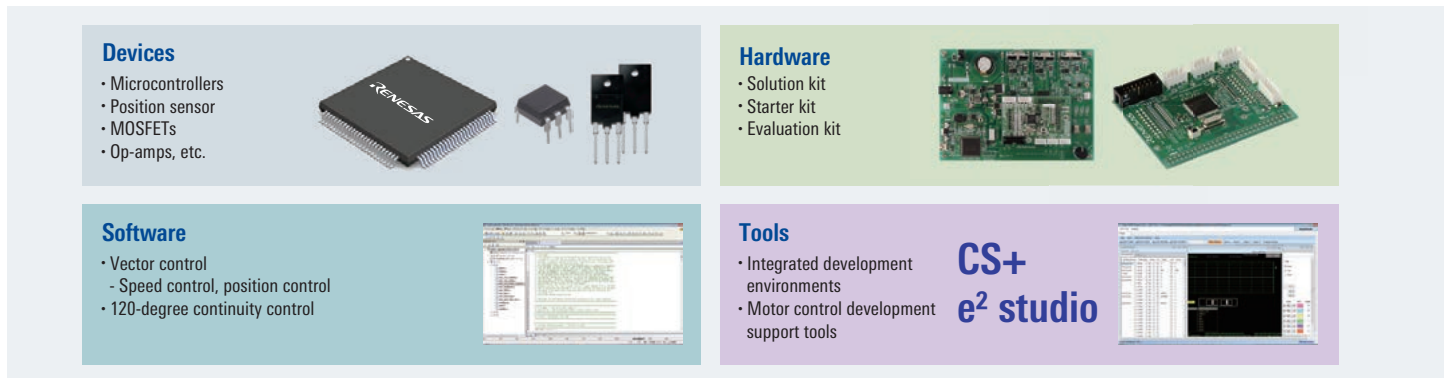

High Availability and Easy Operation

- ▶ Tools and software can be downloaded free of charge from the web, and anyone can feel free to use them.
- ▶ The solution kit can be purchased from an online shop, and you can easily control the motor by using the support tool downloaded from the web.



<https://www.renesas.com/solutions/proposal/motor-control.html>

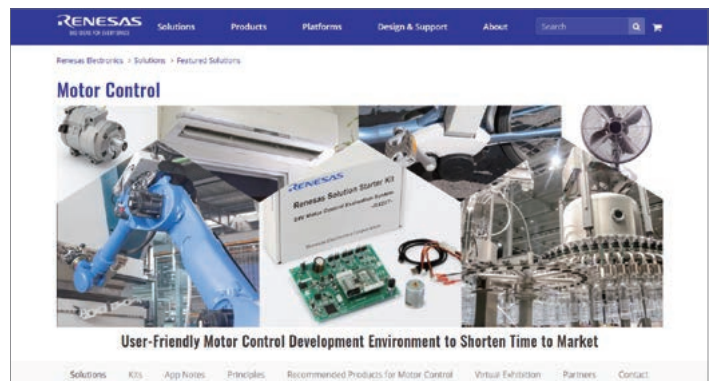

Motor Types and Features

There are various types of motors and the applications used differ according to their features. Renesas offers solutions for permanent magnet synchronous motors (brushless DC motors), stepping motors and induction motors.

Motor Types

The classification of motors is an example, and various other motors exist.

DC Motor

- Brushed motor
- Brushless DC motor (BLDC)

Stepper Motor (Stepping motor)

- Permanent magnet stepper (PM type)
- Variable reactance stepper (VR type)
- Hybrid synchronous stepper (HB type)

AC Motor

- Induction motor (Single phase/Three phases)
- Synchronous motor (SPM, IPM, SynRM)
- Commutator motor

Other Motor

- Ultrasonic motor
- Switched reluctance motor

Motor Features

Brushless DC Motor (BLDC)
 A motor that can rotate without using mechanical contacts (brushes) by using an inverter circuit. A permanent magnet is used for the rotor, and the position of the rotor is detected by a position sensor or sensorless position estimation to control the motor drive. Due to its features of small size, high output, high rotation and long life, it is used in various applications such as home appliances, OA equipment, automobiles and medical equipment.

⇒ Renesas provides kits and sample software that include a brushless DC motor. (page 7, 8)

Stepper Motor
 A motor that rotates based on the pulse signal input to the drive circuit and is mainly used in industrial robots and printers that require position control. There are PM type that uses a permanent magnet for the rotor, VR type that uses a gear-shaped iron core for the rotor, and HB type that has the characteristics of both PM type and VR type. Generally, open loop control which does not require feedback is used, but more and more advanced applications are being provided by feeding back the sensor output.

⇒ Renesas offers stepper motor solutions that use a resolver sensor. (page 10, 11)

Induction Motor
 It is a motor that rotates by magnetic induction. By directly inputting AC power to the motor, it can rotate without a special drive unit. Vector control using a drive device such as an inverter enables variable speed operation and high-efficiency operation according to the load. Mainly used in industrial machines such as fans, pumps, conveyors and trains.

⇒ Renesas offers induction motor solutions for fans and pumps. (page 12)

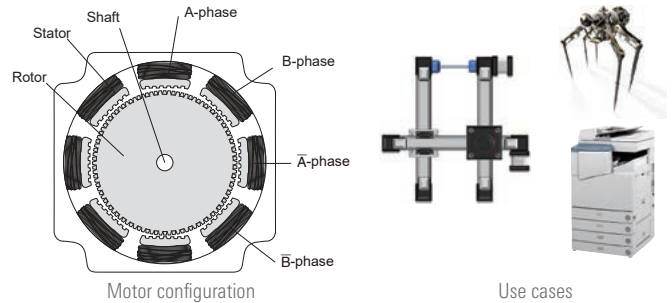
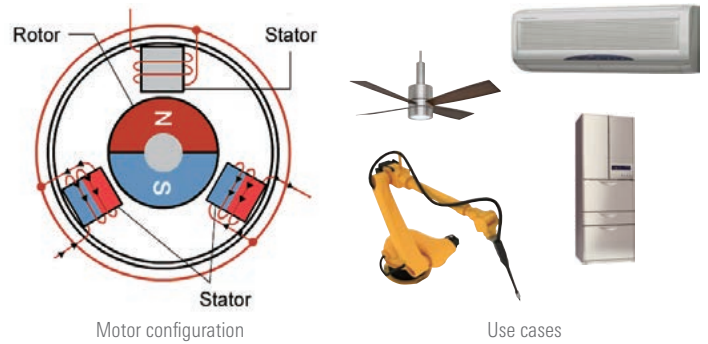

Source: Nidec Corporation

Motor Control Method

Introduces the method for driving the motor. Renesas has released 120-degree conducting control (Trapezoidal control) and vector control as sample software. Each has a feature and is selected according to the purpose. It can be downloaded from the WEB and can be used as a reference for your program.

120-Degree Conducting Control (Square Wave Control)

Features

- Simple control method with low software load
- It is vulnerable to load fluctuation due to the control method that does not detect current
- Precision and efficiency are inferior to vector control

In this control, two of the three coils of the BLDC motor are energized, and six energizing patterns are switched.

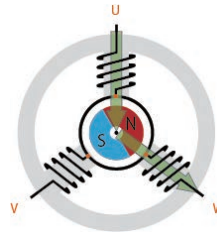

Energizing Mode	Energized Phase	Resultant Flux
1	U → W	
2	U → V	
3	W → V	
4	W → U	
5	V → U	
6	V → W	

Image of energization pattern for 120-degree conducting control

Vector Control

Features

- Advanced control method that detects current and performs fine control
- Highly accurate and efficient control can be realized
- Complex processing is required, and software load is high

In this control, by energizing all three coils and finely controlling the rotating magnetic field, smoother driving is possible compared to 120-degree control. A feature of vector control is that the three-phase AC values are coordinate-converted into two-phase DC values to facilitate control.

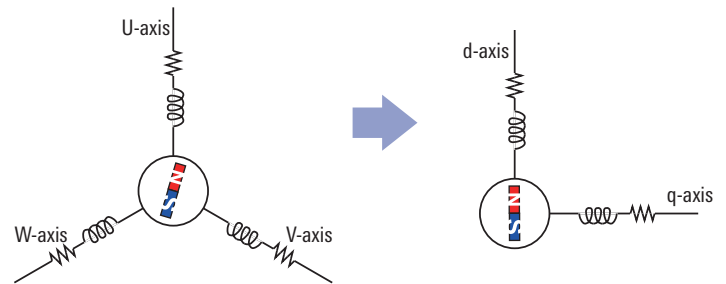

Image of coordinate conversion by vector control (3-phase motor)

Position Sensor of Motor

The required sensor is different between when controlling the "motor speed" like a fan and when controlling the "motor position" like a robot. Each sensor has its own characteristics, and the appropriate sensor is used according to the application. Renesas offers sample software that uses Hall sensor, Encoder, Resolver, and Inductive position sensor, which are typical motor control position sensors. We also provide sample software for "position sensorless" control that does not use these position sensors.

Hall Sensor

- It is mainly used as an output corresponding to the switching of energization of 120-degree conducting control using three Hall sensors.
- It is also possible to control the speed from the output of the hall sensor.
- Because of its low cost, the output may be used for purposes such as functional safety.

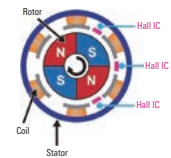

Motor with hall sensor

Encoder

- There are optical encoders using light emitting/transmitting elements and slits, and magnetic encoders using magnetic sensors.
- Wide lineup from inexpensive low resolution to expensive high resolution.
- High resolution encoders are used in robots and AC servos.
- There is also an absolute type that can detect the absolute position.



Encoder

Resolver

- A sensor that detects the position from the magnetic fluctuation between the rotor and stator.
- It is highly resistant to external factors such as dust, heat, and vibration, and is mainly used in the automotive and industrial fields.
- A resolver digital converter is used to obtain the analog signal at the output of the resolver and use it for control.
- High accuracy is possible by correcting/removing resolver winding error and output signal noise.

⇒ See page 10 for resolver digital converter



Motor with resolver

Inductive Position Sensors

- A position sensor that uses electromagnetic induction detects the position using a coil.
- Strong against external factors such as dust, heat and vibration.
- There are products that do not use magnets for detection, and products that are made smaller by supplementing the coil with a board pattern.

⇒ See page 13 for Renesas inductive sensor

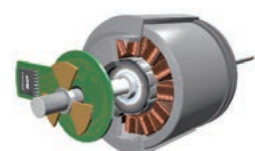

Induction sensor image

Renesas Solutions for Motor Types and Control Methods

Renesas provides kits and motor control software according to the motor type and control microcomputer. Since the sample software prepared for each kit differs, refer to the appropriate solution from the correspondence table below.

Provided as a Kit by Renesas

Motor Type	Name of Kit Used	Reference Page	Vector Control			120-Degree Conducting Control	
			Sensorless	Optical Encoder	Resolver	Sensorless	Hall Sensor
			Speed Control	Speed / Position Control	Speed / Position Control	Speed Control	Speed Control
BLDC	Evaluation System for BLDC Motor + CPU card RTK0EMX270S00020BJ	7	✓	–	–	✓	✓
	24V Motor Control Evaluation System for RX23T RTK0EM0006S01212BJ	7	✓	–	–	✓	✓
	Motor Control Evaluation System for RAJ306010 RTK0EML2C0S01020BJ	8	–	–	–	✓	✓
	RZ/T1 motion control solution kit RTK7910018D00000BU	8	–	✓	–	–	–
Stepping motor	Evaluation System for Stepping Motor with Resolver RTK0EMX270S01020BJ	10, 11	–	–	✓	–	–

Renesas Kit + Motor with Encoder

It is necessary for the customer to prepare a motor with an optical encoder.

Motor Type	Name of Kit Used	Reference Page	Vector Control			120-Degree Conducting Control	
			Sensorless	Optical Encoder	Resolver	Sensorless	Hall Sensor
			Speed Control	Speed / Position Control	Speed / Position Control	Speed Control	Speed Control
BLDC	Evaluation System for BLDC Motor + CPU card RTK0EMX270S00020BJ	7	–	✓	–	–	–
	24V Motor Control Evaluation System for RX23T RTK0EM0006S01212BJ	7	–	✓*1	–	–	–
	Motor Control Evaluation System for RAJ306010 RTK0EML2C0S01020BJ	8	–	✓	–	–	–

*1: Magnetic encoder is also available. (It is necessary to prepare a motor with a magnetic encoder.)

Sample Software/Application Note Provided by Renesas

Motor Type	Name of Kit Used	Reference Page	Vector Control			120-Degree Conducting Control	
			Sensorless	Optical Encoder	Resolver	Sensorless	Hall Sensor
			Speed Control	Speed / Position Control	Speed / Position Control	Speed Control	Speed Control
Induction motor	Evaluation System for ACIM	12	✓*2	–	–	–	–
BLDC	24V Motor Control Evaluation system for RX24T + Magnetic sensor	12	–	✓*3	–	–	–

*2: It is necessary to prepare an induction motor and an inverter board.

*3: It is necessary to prepare a BLDC motor and a magnetic sensor. Motor control using a magnetic encoder is possible.

Solutions for Permanent Magnet Synchronous Motor (BLDC Motor)

Renesas offers permanent magnet synchronous motor solutions to support customers' evaluation and development. Supported devices differ, so please select a solution that uses the product you are considering.

Evaluation System for BLDC Motor

CPU card, sample software, and development support tool are provided to enable motor control immediately after purchase.

Features

- Motor control kit that supports up to DC48V input.
- Compatible with Renesas Motor Workbench for easy debugging.
- Equipped with overcurrent protection function.
- Various motor control MCUs can be evaluated in combination with an optional CPU card.

Kit specifications

Item	Specification
Kit name	Evaluation System for BLDC Motor
Kit model No.	RTK0EMX270S00020BJ
Structure	48V 5A Inverter board for BLDC motor BLDC motor (TG-55L-KA)
Inverter specification	<ul style="list-style-type: none"> Rated voltage: 48V Rated current: 5A (RMS) Protect function: Overcurrent detection, others

Sample Software	Supported MCUs
120-degree conducting control + Speed control (Hall, Sensorless)	RX23T, RX24T
Vector control + Speed control (Encoder, Sensorless)	RX13T* ¹ , RX23T, RX24T, RX24U, RX66T, RX72T, RA6T1
Vector control + Position control (Encoder)	RX23T, RX24T, RX24U, RX66T, RX72T, RA6T1

*1: Sensorless only.

Supported Devices

MCU: RX13T, RX23T, RX24T, RX24U, RX66T, RX72T, RA6T1

Gate Driver: HIP4086ABZT

MOSFET: RJK1054DPB, RJK0854DPB

Regulator: ISL9001AIRNZ



Evaluation System for BLDC Motor + CPU card

Overall Structure

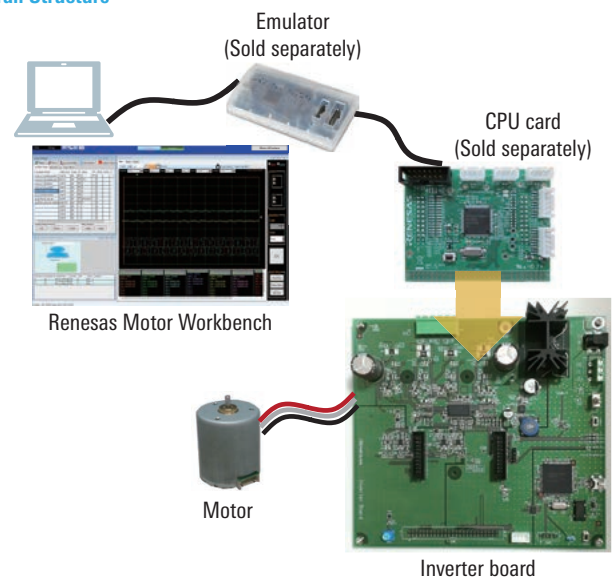

* A kit that includes the RA6T1 CPU card in this inverter board is also available. *Motor Control Evaluation System for RA Family - RA6T1 Group*

24V Motor Control Evaluation System for RX23T

Motor solution that includes CPU card. A learning kit which is the basis of the Evaluation System for BLDC Motor allows you to try various control methods.

Features

- Many CPU cards are made available, enabling motor control in various MCUs.
- Compatible with Renesas Motor Workbench for easy debugging. Various sample software are available.
- Compatible with sample software for RL78/G1F 1-shunt vector control and sensorless 120-degree conducting control with initial position detection function.
- Supports vector control sample software and application note using RX24T magnetic sensor.

Supported Devices

MCU: RL78/G1G, RL78/G1F, RL78/G14, RL78/G1M, RX13T, RX23T, RX24T, RX24U, RX66T, RX72T

MOSFET: N0602N-S19-AY



24V Motor Control Evaluation System for RX23T

Kit specifications

Item	Specification
Kit name	24V Motor Control Evaluation System for RX23T
Kit model No.	RTK0EM0006S01212BJ
Structure	24V 2A Inverter board for BLDC motor RX23T CPU card BLDC motor (TG-55L-KA)
Inverter specification	<ul style="list-style-type: none"> Rated voltage: 24V Rated current: 2A (RMS) Protect function: Overcurrent detection, others

Sample Software	Supported MCUs
120-degree conducting control + Speed control (Hall, Sensorless)	RL78/G1M, RL78/G1G, RL78/G14, RL78/G1F, RX23T, RX24T
Vector control + Speed control (Encoder, Sensorless)	RL78/G1F* ¹ , RX13T* ¹ , RX23T, RX24T* ² , RX24U, RX66T, RX72T, RA6T1
Vector control + Position control (Encoder)	RX23T, RX24T* ² , RX24U, RX66T, RX72T, RA6T1

*1: Sensorless only.

*2: Compatible with magnetic encoders.

Solutions for Permanent Magnet Synchronous Motor (BLDC Motor)

Motor Control Evaluation System for RAJ306010

Easy to start motor evaluation with Renesas evaluation motor and sample software.

Features

- System miniaturization [Board size reduction by 50%]
- Motor control evaluation kit supports DC: 24V
- Easy development environment for BLDC motor

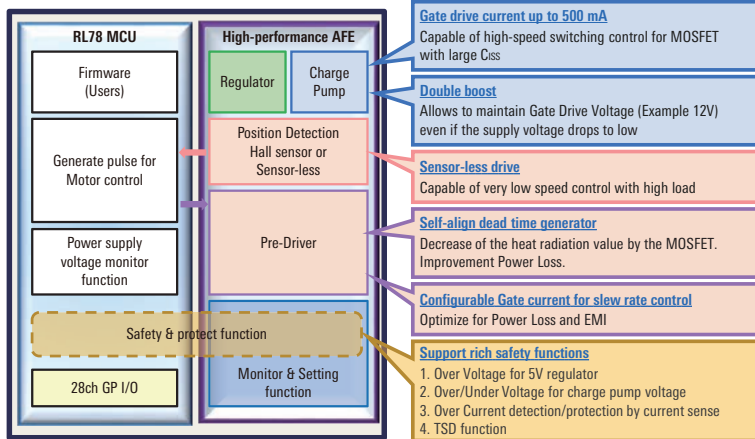

Motor Control Evaluation System for RAJ306010

Kit specifications

Item	Specification
Kit name	Motor Control Evaluation System for RAJ306010
Kit model No.	RTK0EML2C0S01020BJ
Structure	24V Inverter board for BLDC motor
	BLDC motor (TG-55L-KA)
Inverter specification	Rated voltage: 24V
	Rated current: 420mA (RMS) Use included motor

Sample Software	Supported Products
120-degree conducting control (Hall)	RAJ306010
120-degree conducting control + Speed control (Hall)	RAJ306010
120-degree conducting control + Speed control (Sensorless)	RAJ306010
180-degree conducting control + Speed/position control (Encoder)*1	RAJ306010

*1: Please prepare a motor with an encoder separately.

Please contact us via the web for kits that can be used with RAJ306001.

Supported Devices

Part No.	Package	Operating Voltage (V)	Applications
RAJ306010GNP *2	P-HTQFN64 (8mm x 8mm) [terminal compatible]	6 to 42V (LiB: 2 to 10 Cell)	Power tool (36V), Gardening tool, Cord-less vacuum cleaner (8 to 10 cell), Cooling-fan (36V), etc.

*2: Ta: -40 to +85°C RAJ306001GNP, RAJ306010GNP Ta: -40 to +105°C RAJ306001ZGNP, RAJ306010ZGNP

RZ/T1 Motion Control Solution Kit

Features

- Package includes all parts needed for motor control evaluation.
- Supports safe design and can be used for reference.
- Includes motion utility tool. The tool includes motor parameter setting and tuning functions. Supports multiple motor control methods, including trapezoidal control and S-curve acceleration and deceleration control.
- Sample code for servo control via the industrial Ethernet (EtherCAT, CiA402).



RZ/T1 Motion Control Solution Kit

Kit specifications

Item	Specification
Kit name	RZ/T1 Motion Control Solution Kit
Kit model No.	RTK7910018D00000BU
Structure	24V 15A Inverter board for BLDC motor
	BLDC motor with encoder (MB057GA140)
Inverter specification	Rated voltage: 24V
	Rated current: 15A (RMS)
	Protect function: Overcurrent detection, others

Sample Software	Supported MPUs
Vector control + Speed control (Encoder)	RZ/T1
Vector control + Position control (Encoder)	RZ/T1

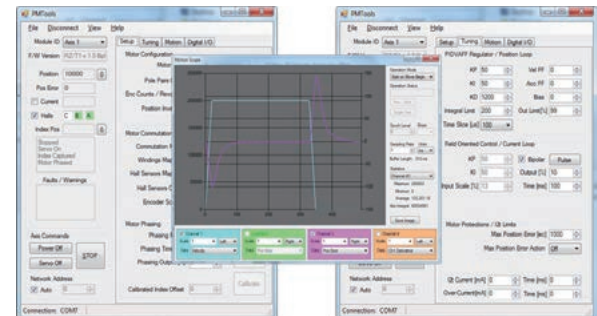

Motion Utility Tool

Overall Structure

- RZ/T1 CPU board, low voltage 2-axis drive inverter board
- Motion Utility Tool
- AC servo motor
- Simple probe for debugging (IAR Systems I-jet Lite)

Supported Devices

- MPU: RZ/T1
- MOSFET: RJK1003DPN
- Receiver: ISL32173E
- Transmitter: ISL32179E
- Transceiver: ISL41387

Solutions for Permanent Magnet Synchronous Motor (BLDC Motor)

Recommended Products

MCUs and MPUs

Part No.	Operating Frequency	Key Features
RL78/G1M	20MHz	8-bit MCU, 5V Operation, Less pin package, Specialized for 120-degree conduction control
RL78/G1G	24MHz	16-bit MCU, 5V operation, Less pin package
RL78/G14	32MHz	16-bit MCU, 5V operation, Less pin package, Various line up
RL78/G1F	32MHz	16-bit MCU, 5V operation, Less pin package, Built-in comparator and PGA ^{*2}
RX13T	32MHz	32-bit MCU, FPU ^{*1} , 5V operation, Built-in PGA ^{*2}
RX23T	40MHz	32-bit MCU, FPU ^{*1} , 5V operation
RX24T	80MHz	32-bit MCU, FPU ^{*1} , 5V operation, Built-in PGA ^{*2,3} , 2 motor control
RX24U	80MHz	32-bit MCU, FPU ^{*1} , 5V operation, Built-in PGA ^{*2,3} , 2 motor control
RX66T	160MHz	32-bit MCU, FPU ^{*1} , 5V operation, Built-in PGA ^{*2,3} , 4 motor control, Security module
RX72T	200MHz	32-bit MCU, FPU ^{*1} , 5V operation, Built-in PGA ^{*2,3} , Built-in TFU ^{*4} , 4 motor control, Security module
RA6T1	120MHz	32-bit MCU, Arm Cortex-M4 Processor, Built-in PGA ^{*2,3} , 2 motor control, Security module
RZ/T1	300/450/600MHz	32-bit MPU, Arm Cortex-R4 Processor, FPU ^{*1} , Absolute encoder I/F, R-IN engine

*1: Floating Point Unit

*2: Programmable Gain Amplifier

*3: Pseudo-Differential PGA

*4: Arithmetic Unit for Trigonometric Functions

Motor control IC (Integrated product of MCU and gate driver)

Part No.	Operating Frequency	Key Features
RAJ306010	32MHz	Built-in RL78/G1F, gate driver (6 to 42V)

Analog, Power devices

Category	Part No.	Key Features
MOSFET	N0602N-S19-AY	Nch Power MOSFET, 60V/100A, $R_{DS(on)} = 4.6 \text{ m}\Omega$
	RJK0854DPB	Nch Power MOSFET, 80V/25A, $RDS(on) = 13 \text{ m}\Omega \text{ max.}$
	RJK1054DPB	Nch Power MOSFET, 100V/20A, $RDS(on) = 22 \text{ m}\Omega \text{ max.}$
	RJK1003DPN-A0	Nch Power MOSFET, 100V/50A, $RDS(on) = 11 \text{ m}\Omega \text{ max.}$
Gate Driver	HIP4086ABZT	3 phase MOSFET driver, 80V, 500mA
Regulator	ISL9001AIRNZ	2.3 to 6.5V operation, PSRR: 90dB@1kHz, Low power
	ISL9005AIRNZ	2.3 to 6.5V operation, PSRR: 75dB@1kHz, Low power
RS-485/RS-422	ISL32173EFVZ	RS-485/RS-422 receiver, 3.0 to 5.5V operation
	ISL3159E	RS-485/RS-422 transceiver, 3.0 to 5.5V operation, fail-safety function
	ISL8485E	RS-485/RS-422 transceiver, 3.0 to 5.5V operation
RS-422	ISL32179EFRZ	RS-422 transmitter, 3.0 to 5.5V operation, Low power
RS-485/RS-232	ISL41387IRZ	RS-485/RS-232 transceiver, $\pm 15\text{kV}$ ESD

Solutions for Stepping Motor

Resolver motor control solutions featuring superlative cost performance

Resolver Motor Control Solutions

These resolver-based motor control solutions are motor control systems for industrial and consumer applications realized by combining resolver-to-digital converter (RDC) ICs and RX Family microcontrollers (MCUs). It is possible to easily control a resolver-based stepping motor or brushless DC motor using the driver software of the microcontroller. Solution kits, sample code, development support tools, and application notes for motors with resolvers are provided, so motor control using resolvers can be started immediately.

- Features
- High-precision motor control is possible even in the harsh environments with heat, dust, or vibration.
 - Realize high-precision control at low cost using a new type of resolver control with superlative cost performance.
 - Resolver signal gain, phase, and angle error are automatically corrected through the driver API that can be used in combination with an RX MCU to achieve high precision.

System configuration

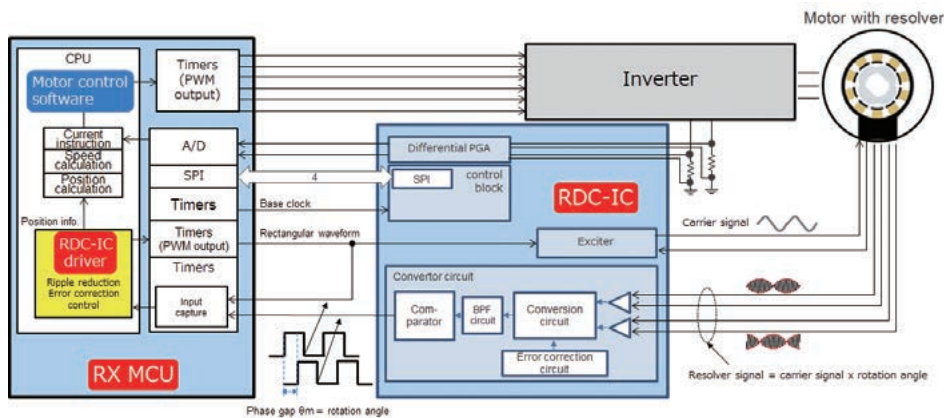

- In resolver-based motor control solutions, the RDC IC and RX MCU process signals from the resolver as angle information, and the RX MCU controls the motor. A dedicated driver for the RDC IC is provided on the RX MCU, and resolver processing can be easily performed using the API.
- Using a portion of the MCU functions makes it possible to simplify the RDC IC and thereby lower its cost.

Motor Control Solutions for Stepping Motors with Resolvers

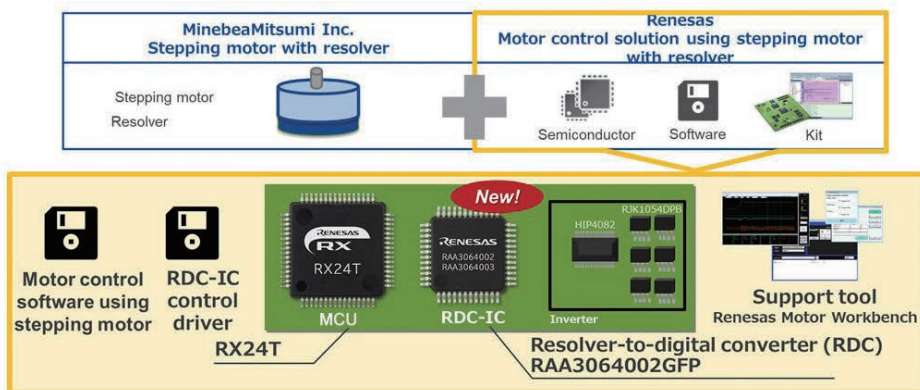

- Stepping motors with resolvers and resolver motor control solutions developed by collaboration between MinebeaMitsumi Inc. and Renesas make it possible to servo control the stepping motor which is normally controlled by the open loop.
- This solution realizes many advantages such as low noise, low vibration, low power consumption and maximization of motor torque.
- ICs, software, development kits, and development support tools for resolver control and motor control are available.

Solution Contents

Stepping motor with resolver: New motor manufactured by MinebeaMitsumi Inc.
 RX24T: MCU for motor control
 Resolver-to-digital converter: IC that converts resolver output into digital signal
 Solution kit: All items necessary for controlling a stepping motor with resolver are provided
 Support tool: Development support tool essential for motor control debugging

Solutions for Stepping Motor

Evaluation System for Stepping Motor with Resolver



Evaluation System for Stepping Motor with Resolver

Kit specifications

Item	Specification
Kit name	Evaluation System for Stepping Motor with Resolver
Kit model No.	RTK0EMX270S01020BJ
Structure	48V 5A Inverter board for stepping motor
	RX24T with RDC IC CPU card
	Stepping motor with Resolver (Minebea Mitsumi)
Inverter specification	<ul style="list-style-type: none"> ■ Rated voltage: 48V ■ Rated current: 2A (RMS) ■ Detect function: Phase current, Bus voltage ■ Protect function: Overcurrent protection

Sample Software	Supported MCUs
Vector control + Speed control (Resolver)	RX23T, RX24T, RX66T, RX72M
Vector control + Position control (Resolver)	RX23T, RX24T, RX66T, RX72M

- Supports RS485, CAN, pulse train command, general-purpose input/output for external device communication as the I/F specification of the kit.
- Equipped with on-board emulator circuit (flash programming circuit).

Recommended Products

MCUs

Part No.	Operating Frequency	Key Features
RX23T	40MHz	32-bit MCU, FPU* ¹ , 5V operation
RX24T	80MHz	32-bit MCU, FPU* ¹ , 5V operation, PGA* ² , 2 motor control
RX66T	160MHz	32-bit MCU, FPU* ¹ , 5V operation, PGA* ^{2,3} , 4 motor control, Security module
RX72M	240MHz	32-bit MCU, Double precision FPU* ¹ , Built-in TFU* ⁴ , Security module, EtherCAT [®] compatible

*1: Floating Point Unit

*2: Programmable Gain Amplifier

*3: Pseudo-Differential PGA

*4: Arithmetic Unit for Trigonometric Functions

Analog, Power devices

Category	Part No.	Key Features
RDC-IC	RAA3064002GFP (85°C) RAA3064003GFP (105°C)	Single-phase induced/Two phase output Rectangle waveform 5/10/20kHz, 2.5Vp-p
Motor Driver	HIP4082	80V, 1.25A Peak Driver
MOSFET	RJK0854DPB	N-Channel 80V, 25A, 10mΩ typ.
	RJK1054DPB	N-Channel 100V, 20A, 17mΩ typ.
AC/DC	ISL6840	1A MOSFET gate driver 60μA start-up current, 100μA maximum 25ns propagation delay current sense to output
DC/DC	ISL85033	Wide VIN Dual Standard Buck Regulator With 3A/3A Continuous Output Current
LDO	ISL80505	500mA LDO
RS-485/RS-422	ISL8485E	ESD Protected to ±15kV, 5V, Low Power, High Speed Rate Limited, RS-485/RS-422 Transceivers
	ISL3159E	40Mbps, 5V, fail safety, RS-485/RS-422 Transceivers

Solutions for AC Induction Motor

Three-phase induction motor solution provides inverter control software to be embedded in a motor control MCU. By providing an inverter control software with a high level of development difficulty, you can easily and reasonably develop a customer-specific inverter.

* This solution uses an inverter board made by a partner and does not provide a kit from Renesas.

Evaluation System for ACIM

Renesas can provide CPU cards, sample software, application notes, development support tools, and can control induction motors in combination with partner-made inverter boards.

Features

- Equipped with speed sensorless vector control function can remove speed sensor to reduce BOM cost and improve reliability.
- Compatible with Renesas Motor Workbench (motor control development support tool), for easy debugging.
- Built-in over current/over voltage/over temperature protection function, enables safe evaluation.
- Various motor control MCUs can be evaluated in combination with an optional CPU card.
- High voltage inverter board is compatible with AC85 to 265Vrms input(Need to be purchased separately from Desk Top Lab Co.,Ltd).

Evaluation Environment Specifications

Item	Specification
Structure	T1102 inverter board
	RX13T CPU card, RX66T CPU card
Inverter specification	Rated voltage: AC 85 to 265V
	Rated current: 15A (RMS)
	Protect function: Overcurrent protection, others

Sample Software	Supported MCUs
Vector control + Speed control (Sensorless)	RX13T, RX66T

Supported Devices

MCU: RX13T, RX66T

Overall Structure



Solutions Using Magnetic Sensors

Motor Control with Magnetic Sensor

Solution to control motor by combining with motor with magnetic sensor

Renesas have released sample software and application notes that can correct the sensor output, which can be used as a reference for motor control using magnetic sensors.

The motor with magnetic sensor used in this solution is not provided as a kit from Renesas.

Features

- Provide sample software and application notes for magnetic sensors with analog output and digital output.
- The analog output magnetic sensor also has an output error correction function.
- Compatible with Renesas Motor Workbench, a motor control development support tool, for easy debugging.
- Equipped with protection functions such as overcurrent and overvoltage detection for safe evaluation.

* Magnetic sensor manufactured by TDK Corporation is used to check the operation of this sample software.

Overall Structure

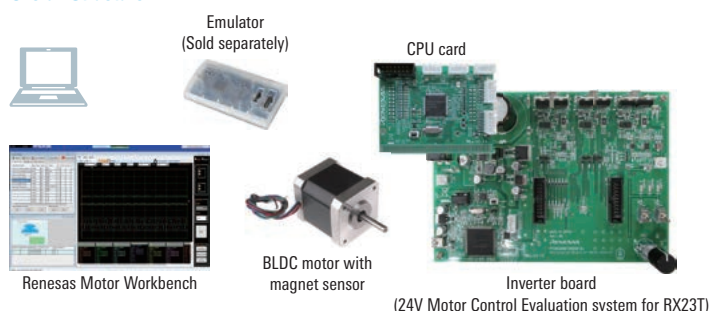

Evaluation Environment Specifications

Item	Specification
Structure	24V 2A Inverter board for BLDC motor
	RX24T CPU card
	BLDC motor with magnetic sensor
Inverter specification	Rated voltage: 24V
	Rated current: 2A (RMS)
	Protect function: Overcurrent detection, others

Sample Software	Supported MCUs
Vector control + Speed control (Magnetic sensor)	RX24T
Vector control + Position control (Magnetic sensor)	RX24T

Supported Devices

MCU: RX24T
MOSFET: N0602N-S19-AY

Solutions Using Inductive Position Sensors

IPS2200 (Inductive Position Sensor)

This is thin, lightweight and cost effective with stray magnetic field immunity and contributes to the design for industrial motor. This is ideal for industrial and medical motor commutation and robot application.

Features

- For control of electrical motor (especially BLDC motor)
- Power-supply voltage: 3.3V or 5V
- Support up to 250,000 rpm, low latency (<10µs)
- Magnet-free, thin, lightweight and low-cost solution
- High stray magnetic field immunity
- Sine/cosine (analog) output
- Support multiple pole pairs
- Operating temperature: -40°C to +125°C
- TSSOP-16

- This is a sensor detecting the position of the target metal based on the electromagnetic induction of the coil.
- The sensing element of IPS2200 enables to match the number of target sectors to pole pairs of the motor to maximize accuracy. Sectors can be mounted both to shaft axis (on-axis) and shaft side (off-axis) of the motor, which increases the degree of freedom of the design.
- This is thin and lightweight with one-tenth thickness and one-hundredth weight of the existing resolvers at maximum.

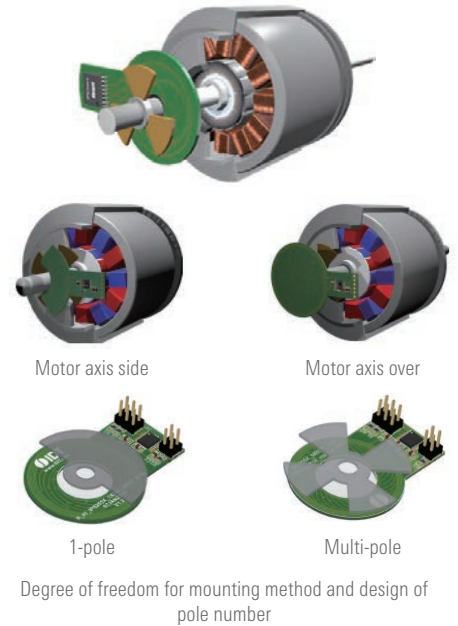

IPS2200STKIT

This is the kit for IPS2200, which includes the detection part of the position sensor and the interface board with PC. By combining with the dedicated GUI, you can easily visualize the angle.

* This kit does not include a motor.
This kit is not designed to perform motor control but to check the output information from the position sensor.

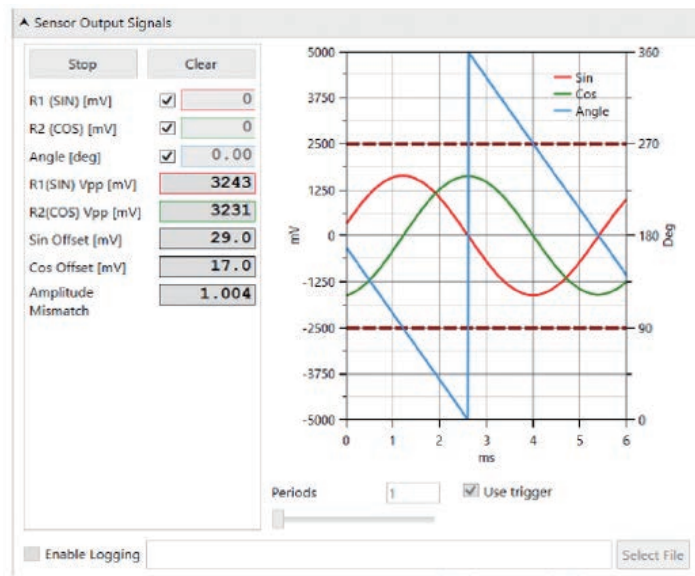

Dedicated GUI

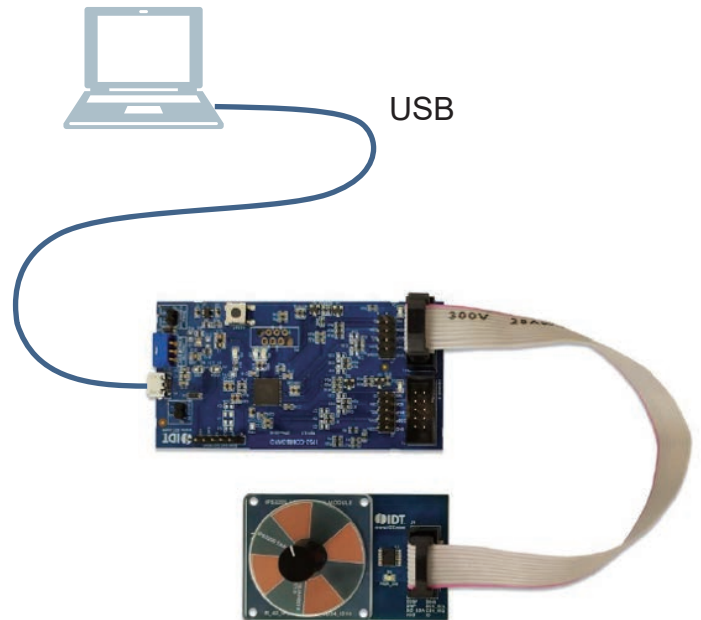

Inductive Sensor Processing IC (IPS2200 Series)

Part No.	Operation Voltage	Operation Temperature	Rated Speed	Output Type	Safety Function	Package	Provide
IPS2200B11R	3.0V to 3.6V or 4.5V to 5.5V	Ta = -40°C to +125°C	Max. 250,000 rpm (Electric angle)	sin/cos (Differential or single ended)	Overvoltage detection, reverse polarity detection output, short circuit protection	TSSOP-16 Pin (5.1mm × 6.4mm)	13" reel - 4000 IC/reel
IPS2200B11W							7" reel - 500 IC/reel

Motor Control Development Support Tool

Renesas Motor Workbench

In the field of motor control, we do not debug while connecting MCU and PC in software development. Debugging while connecting MCU and PC with program stopped is dangerous, because output signal from MCU to the inverter circuit stops, which causes a large current to flow. Therefore, Renesas offers a dedicated development support tool.

Product Summary

- Analyzer function: Dynamic reading/writing of variables and waveform display while operating the motor.
- Tuner function: Automatic identification of motor parameters and control gains required for vector control.
- Output of results is possible: Analyzer waveform display data is in csv format. Tuner identification results can be outputted as PDF file or header file.

Renesas Motor Workbench runs on a PC connected to the target inverter
Strong support for motor control development

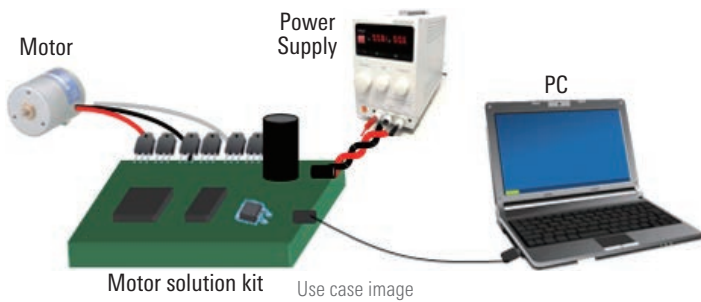

Analyzer

Extensive functions include trigger, zoom, and commander transmission etc., useful for debugging and evaluation. Also usable as user I/F.

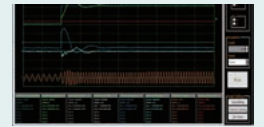

Tuner

Vector control at ease without know-how.
Fine adjustment at ease with manual adjustment function, as well as quick result check.



Analyzer

Functions

- Dynamically write/read variables while driving a motor
- Dynamically display waveform while driving a motor
- Specify trigger and each display settings with the waveform display
- Create and send operating sequence to any variable in advance
- Batch process buttons by user definition

User's voice

- Very useful, you can observe variables inside MCU.
- Amazed at the debugging function without the need to stop CPU. The tool to enable safe analysis operation.

trigger/zoom functions

Step response evaluation at ease with commander (command value creation & transmission)



Display variables for 8 channels (can specify scale and off-set settings etc. per channel)

Tuner

Functions

- Automatically measure motor-unique parameters (resistance, inductance, induced voltage constant variable, and inertia)
- Automatically adjust the PI control gain of current/speed/position
- Automatically adjust the expected gain for sensorless vector control
- Manual tuning to finely adjust each PI control
- Output results in pdf and motor-driver header files



Input information are only rated current and pole pairs.

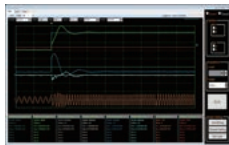

Check adjustment results right away with the analyzer
Output adjustment results in pdf and motor header files available on the Web

Finely adjust the PI gain of current/speed/position

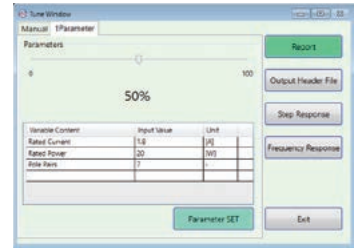
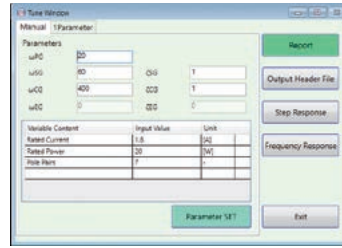

User's voice

- Great help, as I had much trouble in adjusting parameters.
- I could start motor right away after purchase.
- Convenient enough just to be able to use motor parameter.

Specification

Item		Specification
All	Supported MCU	RX13T, RX23T, RX24T, RX24U, RX66T, RX72T, RA6T1 RL78/G1F, RL78/G14 (RL78 family supports the analyzer function only)
	Usage environment (OS)	Windows 10
Communication	Peripherals, port	UART 1 ch, DMA (DTC) Port: TXD, RXD
	Communication I/F	USB2.0 (Communication Device Class)
	Communication board	Tool communication board is required when used under the environment other than Motor RSSK Communication board for tools: W2002 (Desk Top Laboratories Inc.*)
Analyzer	Waveform display	8 channels (scale and off-set setting per channel), zoom function (2 windows), Trigger mode selectable from Single/Auto/Normal, save waveform data in a csv format
	Write/ Read variable	Variables simultaneously selectable up to 255
Tuner*1	Input information	Rated power, Pole pairs only
	Output information	Motor-unique parameter (Resistance, Inductance, Magnet flux, Rotor inertia) and control gain Output file format: pdf file, header file*2

*1: Tuner function is only available for motor RSSK environment.
*2: Support motor control SW header file released by Renesas. See Renesas Motor Workbench User's Manual for details.

Usage environment

- Evaluation System for BLDC Motor
- 24V Motor Control Evaluation System for RX23T



Just need to connect the motor RSSK programmed with control SW to your PC via USB and start-up the tools

Tool communication board is required when used under user environment

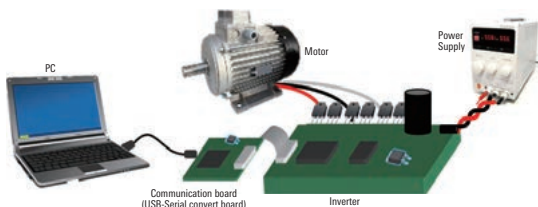

Communication board W2002 ICS++

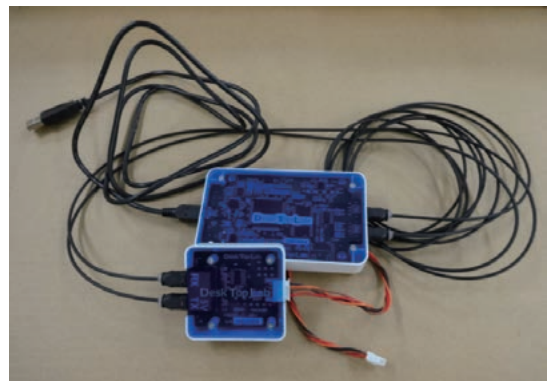

* Desk Top Laboratories Inc.

Desk Top Lab

<http://www.desktoplab.co.jp/>

RAA227063 3-Phase Smart Gate Drivers

RAA227063 Smart 3-Phase

System Integration (Smart Gate Driver with Built-in Power Supply for System and High Accuracy Amp for 3-Shunt)

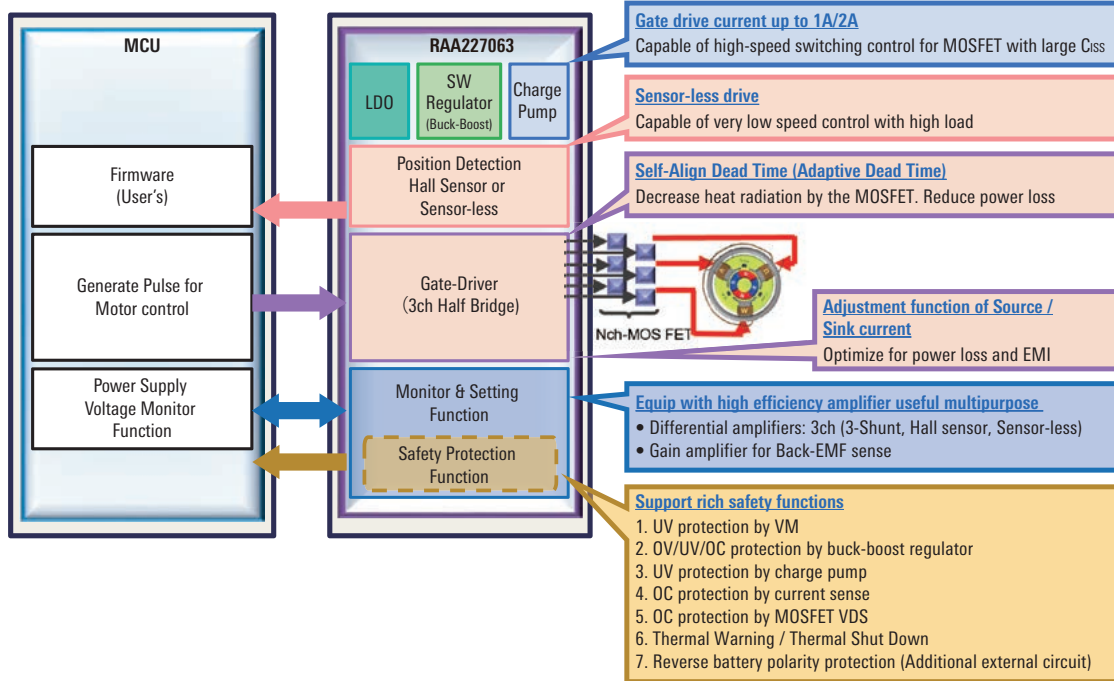

Development Tool

Easy to Connect with Renesas CPU Card, Start to Evaluate by Sample Firmware of Renesas MCU

- PCB size: 14.1cm x 16.0cm
- Power input: 4.5V to 60V, motor driving MOSFETs are rated at 80V 132A.
- MCU connectors are compatible to Renesas RL78/G1F, RX23T, and RA6T1 CPU card interface. (Has interface to MCU for motor current & voltage sensing, PWM signals, fault condition, enable IC, SPI connection, etc.)



CPU Card
(RL78/G1F, RX23T, RA6T1)

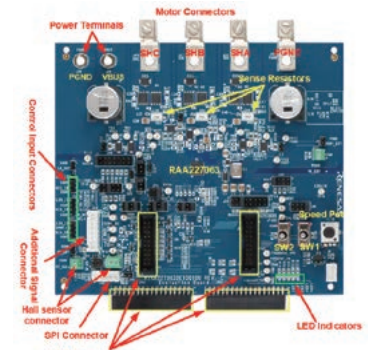

EVB for RAA227063 (RTK227063DE000BU)

Product	PKG	Operating Voltage (V)	Applications
RAA227063*1	48 Ld QFN (7mm × 7mm)	4.5 to 60V	Power tool, Gardening tool, Cord-less vacuum cleaner, Cooling-fan, Water pump, Air pump, AGV, Robotics, etc.

*1: RAA2270634GNP#MA0: Reel 250pcs Ta= -40 to 125 °C
RAA2270634GNP#HA0: Reel 4k pcs Ta= -40 to 125 °C

Inquiry window

Please contact customer support via the website for further information.

<https://www.renesas.com/us/en/>

Recommended Products: MCUs and MPUs

RL78 Family

Part No.	Pin Number	ROM (KB)	RAM (KB)	Operating Frequency	Power-supply Voltage
RL78/G14	30 to 64	16 to 64	2.5 to 5.5	32MHz	1.6 to 5.5V
	80 to 100	96 to 512	12 to 48		
RL78/G1F	24 to 64	32/64	5.5	32MHz	1.6 to 5.5V
RL78/G1G	30 to 44	8/16	1.5	24MHz	2.7 to 5.5V
RL78/G1M	20	4/8	0.512/1	20MHz	2.0 to 5.5V

RX Family

Part No.	Pin Number	ROM (KB)	RAM (KB)	Operating Frequency	Power-supply Voltage
RX13T	32 to 48	64 to 128	12	32MHz	2.7 to 5.5V
RX23T	48 to 64	64 to 128	12	40MHz	2.7 to 5.5V
RX24T	64 to 100	128 to 512	16 to 32	80MHz	2.7 to 5.5V
RX24U	100 to 144	256 to 512	32	80MHz	2.7 to 5.5V
RX66T	64 to 144	256 to 1024	64 to 128	160MHz	2.7 to 5.5V
RX72T	100 to 144	512 to 1024	128	200MHz	2.7 to 5.5V

RZ Family

Part No.	Pin Number	ROM (KB)	RAM (KB)	Operating Frequency	Power-supply Voltage
RZ/T1	176/320	0	544 to 1568	600MHz	3.0 to 3.6V
RZ/T1-M	112	0	544 to 1568	450MHz	3.0 to 3.6V

RA Family

Part No.	Pin Number	ROM (KB)	RAM (KB)	Operating Frequency	Power-supply Voltage
RA6T1	64/100	256/512	64	120MHz	3.0 to 3.6V
RA6T2	48/64/100	512	64	240MHz	3.0 to 3.6V

Recommended Products: Motor Sensor Processing IC, Motor Control IC

RDC IC (Resolver to Digital Converter)

Part No.	Resolver Driving Block			Converter Block			Amplifier Circuit Block	Control Block		Conversion Error	Power-supply Voltage	Power-supply Current	Operating Ambient Temperature	Package
	Input	Excitation Signal Output	Over Temperature Detection Circuit	Differential Amplifier Circuit	Signal Conversion Circuit	Disconnection Detection Circuit	Differential Amplifier Circuit	Communication Function	Operating Frequency					
RAA3064002GFP	Square wave: 5/10/20 kHz	Alternating current: 35mA _{p-p} (Max.)	Built-in	Gain Variable: 2, 4, 8, 16.5 times	Angle error correction function, Internal circuit error correction function	Detect disconnection from signal amplitude	2 ch (Support differential input), Gain variable: 10, 25 times	SPI interface (Max. 1MHz)	4MHz	±0.2°	VDD = 4.5-5.5V, IOVDD = AVDD	Maximum operating current: 20 mA (Typ.)	-40°C to +85°C	LQFP-48pin (7mm × 7mm)
RAA3064003GFP													-40°C to +105°C	

3 Phase BLDC Motor Control (RAJ306000 Series)

Part No.	Motor Drive Voltage	MCU	Communication I/F	Timer	Guaranteed Operating Temperature Range	5V Regulator Accuracy	A/D Converter	Pre-Driver Block		Safety Function	Package
								Gate Drive Peak Current	Boosting Function		
RAJ306010GNP/ZGNP	VM = 6V to 42V	RL78G1F (Flash ROM: 64KB, RAM: 5.5KB)	3 units (SPI: 2ch, IIC: 2ch, UART: 1ch)	16-bit timer: 8ch	GNP: Ta = -40°C to +85°C, ZGNP: Ta = -40°C to +105°C	5V ± 1% (Ta = 25°C)	9ch (Resolution: 10-bit)	500mA Drive peak current supporting up to 500mA, Dead time adjustment function, Gate current adjustment function	Double boost / Single boost switch	Over temperature protection, Overvoltage detection, Overcurrent detection/protection, Output phase overcurrent detection/ protection, Low voltage detection/ protection	P-HTQFN-64 Pin (8mm × 8mm)

Inductive Sensor Processing IC (IPS2200 Series)

Part No.	Operation Voltage	Operation Temperature	Rated Speed	Output Type	Safety Function	Package	Provide
IPS2200B1R	3.0V to 3.6V or 4.5V to 5.5V	Ta = -40°C to +125°C	Max. 250.000 rpm (Electric angle)	sin/cos (Differential or single ended)	Overvoltage detection, reverse polarity detection output, short circuit protection	TSSOP-16 Pin (5.1mm × 6.4mm)	13" reel - 4000 IC/reel
IPS2200B1W							7" reel - 500 IC/reel

Recommended Products: Power Management

ISOLATED PWM

Pout < 200W

* Used for Step-down from 200V to 24V and so on.

Part No.	Description	Control Mode	UVLO Rising (V)	UVLO Falling (V)	Vbias max (V)	No Load Operating Current (mA)	PWM Output Number	Error Amplifier	FET Driver Iout max (A)	Switching Frequency (Hz)	Maximum Duty Cycle (%)	Package
ISL6840	Industry standard single end	Peak current mode	7	6.6	20	3.3	1	Built-in	1	4k to 2M	96	8Ld MSOP, 8Ld DFN
ISL6726	Active clamp · forward	Current mode	7.65	6.23	22	10	1	–	2	10k to 1M	80	20Ld QSOP
ISL8840A to ISL8845A	High performance · Industry standard single end	Peak current mode	7, 8.4, 14.3	6.6 to 8.8	30	2.9	1	Built-in	1	2k to 2M	48, 96	8Ld SOIC, 8Ld MSOP

DC/DC

Part No.	Vin (V)	Vout (min) (V)	Iout (A)	Fsw (Hz)	Forced PWM/PFM Switch	Efficiency (%)	On Resistance typ (mΩ)	Operating Temperature Range	Package
ISL85415	3 to 36V	0.6 to 34	0.5	300k to 2M	✓	up to 94	High: 450 Low: 250	–40°C to +125°C	4 × 3 × 1.0 12Ld DFN
ISL85410	3 to 40V	0.6 to 34	1.0	300k to 2M	✓	up to 96	High: 250 Low: 90	–40°C to +125°C	4 × 3 × 1.0 12Ld DFN
ISL854102	3 to 40V	0.6 to 34	1.2	300k to 2M	✓	up to 93	High: 250 Low: 90	–40°C to +125°C	4 × 3 × 1.0 12Ld DFN
ISL85033	4.5 to 28V	0.8	3/3	300k to 2M	–	up to 93	75	–40°C to +85°C	TQFN28

LDO

Part No.	Description	Output Number	Vin (min) (V)	Vin (max) (V)	Vout (V)	Reference Voltage Accuracy (%) Full Temperature Range	Current Limit Iout (typ) (mA)	PSRR@ 1kHz (dB)	Iq (μA) typ	Dropout Voltage typ (mV)	Output Noise (typ) (μV/rms)	Package
ISL9001A	Low Iq, High PSRR	1	2.3	6.5	1.5, 1.8, 2.5, 2.8, 2.85, 3.3	±1.8	475	90	25	200@300mA	30@100μA	DFN8
ISL9005A	Low Iq, High PSRR	1	2.3	6.5	1.5, 1.8, 2.5, 2.8, 2.85, 3.3	±1.8	475	75	50	200@300mA	45@100μA	DFN8
ISL9007	Low noise, Low Iq, High PSRR	1	2.3	6.5	1.8, 2.5, 2.8, 2.85, 3.3	±1.8	540	75	50	250@400mA	30@100μA	MSOP8
ISL80505	High performance 0.5A LDO	1	1.8	6	ADJ	±1.8	1200	57	2200	45@0.5A	79@0.5A	DFN8
ISL80510	High performance 1A LDO	1	2.2	6	ADJ	±1.8	1750	48	2200	130@1A	75@1A	DFN8
ISL80410	150mA, 40V, Low Iq	1	6	40	ADJ	±1.0	410	66 @100Hz	90	295@150mA	–	EPSONC8
ISL6719	100V Linear bias power supply	1	17	100	ADJ	±3.3	230	–	1100	1800@100mA	–	DFN9
ISL80101A	High performance 1A LDO, Current limit can be set	1	2.2	6	ADJ	±2.0	1620	48	3000	90@1A	100@1A	DFN10

Recommended Products: Gate Driver, MOSFET, Peripheral IC

Gate Driver: For MOSFET Driver Bridge

Part No.	Maximum Boot Strap Voltage (V)	Maximum Bias Voltage (V)	Input System/ Output System	Peak Pull-up/ down Current (A)	Turn on/off Propagation Delay (nS)	Rising/Falling Time (nS)	Package	Remarks
HIP2211	115	18	2/2	3/4	30/30	6/6	8 Ld SOIC, 8/10 Ld 4 × 4 DFN	
HIP4082	95	15	4/4	1.4/1.3	75/55	9/9	16Ld PDIP, 16Ld SOIC	
HIP4086A	95	15	6/6	1/1	20/10	10/10	20Ld PDIP, 20Ld SOIC	80V, 500mA, 3-Phase MOSFET Driver

MOSFET Driver

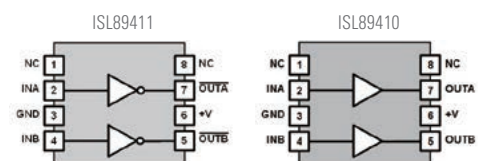

$V_s = 18V$ (max)
 $I_{pk} = 2A$ (max)
 8Ld PDIP, SOIC

IGBT Gate Driver Coupler

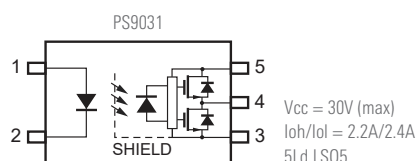

Inverter Circuit: Power MOSFET

Part No.	Nch/Pch	Resisting Pressure	Current	ON Resistance (max)	Package
RJK1054DPB	Nch Single	100V	20A	22mΩ	LFPK
RJK0854DPB	Nch Single	80V	25A	13mΩ	LFPK
RJK0454DPB	Nch Single	40V	40A	4.9mΩ	LFPK
RJK0455DPB	Nch Single	40V	45A	3.8mΩ	LFPK
RJK0456DPB	Nch Single	40V	50A	3.2mΩ	LFPK
NP75N04YUK	Nch Single	40V	75A	3.3mΩ	HS0N-8
NP50N04YUK	Nch Single	40V	50A	4.8mΩ	HS0N-8
NP30N04QUK	Nch Dual	40V	30A	8mΩ	HS0N-8
NP29N04QUK	Nch Dual	40V	30A	10.1mΩ	HS0N-8

Peripheral IC: RS-485 Transceiver

Type	Duplex	Part No.	Data Rate	Supply Voltage	Temp Range	Fail Safe	Hot Plug	Remarks	
Low cost	Transceiver	Half	ISL8485E	10Mbps	5V	-40°C to +85°C / +125°C	Open	N	
IEC61000 ESD protection Full function	Transceiver	Half	ISL3152E / 55E / 58E	115k / 1M / 20Mbps	5V	-40°C to +85°C	Full	Y	Min. 2.4V High output voltage
		Full	ISL3150E / 53E / 56E						
High speed, Full function IEC61000 ESD protection	Transceiver	Half/Full	ISL3159E / 60E	40Mbps	5V	-40°C to +85°C / +125°C	Full	Y	Min. 2.1V High output voltage
			ISL3179E / 80E		3.3V				
±60V Overvoltage protection	Transceiver	Half	ISL32492E / 95E / 98E	250k / 1M / 15Mbps	5V	-40°C to +85°C	Full	Y	±25V Common mode voltage Min. 2.0V High output voltage @5V
		Full	ISL32490E / 93E / 96E						

Notice

1. Descriptions of circuits, software and other related information in this document are provided only to illustrate the operation of semiconductor products and application examples. You are fully responsible for the incorporation or any other use of the circuits, software, and information in the design of your product or system. Renesas Electronics disclaims any and all liability for any losses and damages incurred by you or third parties arising from the use of these circuits, software, or information.
 2. Renesas Electronics hereby expressly disclaims any warranties against and liability for infringement or any other claims involving patents, copyrights, or other intellectual property rights of third parties, by or arising from the use of Renesas Electronics products or technical information described in this document, including but not limited to, the product data, drawings, charts, programs, algorithms, and application examples.
 3. No license, express, implied or otherwise, is granted hereby under any patents, copyrights or other intellectual property rights of Renesas Electronics or others.
 4. You shall be responsible for determining what licenses are required from any third parties, and obtaining such licenses for the lawful import, export, manufacture, sales, utilization, distribution or other disposal of any products incorporating Renesas Electronics products, if required.
 5. You shall not alter, modify, copy, or reverse engineer any Renesas Electronics product, whether in whole or in part. Renesas Electronics disclaims any and all liability for any losses or damages incurred by you or third parties arising from such alteration, modification, copying or reverse engineering.
 6. Renesas Electronics products are classified according to the following two quality grades: "Standard" and "High Quality". The intended applications for each Renesas Electronics product depends on the product's quality grade, as indicated below.
"Standard": Computers; office equipment; communications equipment; test and measurement equipment; audio and visual equipment; home electronic appliances; machine tools; personal electronic equipment; industrial robots; etc.
"High Quality": Transportation equipment (automobiles, trains, ships, etc.); traffic control (traffic lights); large-scale communication equipment; key financial terminal systems; safety control equipment; etc.
Unless expressly designated as a high reliability product or a product for harsh environments in a Renesas Electronics data sheet or other Renesas Electronics document, Renesas Electronics products are not intended or authorized for use in products or systems that may pose a direct threat to human life or bodily injury (artificial life support devices or systems; surgical implantations; etc.), or may cause serious property damage (space system; undersea repeaters; nuclear power control systems; aircraft control systems; key plant systems; military equipment; etc.). Renesas Electronics disclaims any and all liability for any damages or losses incurred by you or any third parties arising from the use of any Renesas Electronics product that is inconsistent with any Renesas Electronics data sheet, user's manual or other Renesas Electronics document.
 7. No semiconductor product is absolutely secure. Notwithstanding any security measures or features that may be implemented in Renesas Electronics hardware or software products, Renesas Electronics shall have absolutely no liability arising out of any vulnerability or security breach, including but not limited to any unauthorized access to or use of a Renesas Electronics product or a system that uses a Renesas Electronics product. RENESAS ELECTRONICS DOES NOT WARRANT OR GUARANTEE THAT RENESAS ELECTRONICS PRODUCTS, OR ANY SYSTEMS CREATED USING RENESAS ELECTRONICS PRODUCTS WILL BE INVULNERABLE OR FREE FROM CORRUPTION, ATTACK, VIRUSES, INTERFERENCE, HACKING, DATA LOSS OR THEFT, OR OTHER SECURITY INTRUSION ("Vulnerability Issues"). RENESAS ELECTRONICS DISCLAIMS ANY AND ALL RESPONSIBILITY OR LIABILITY ARISING FROM OR RELATED TO ANY VULNERABILITY ISSUES. FURTHERMORE, TO THE EXTENT PERMITTED BY APPLICABLE LAW, RENESAS ELECTRONICS DISCLAIMS ANY AND ALL WARRANTIES, EXPRESS OR IMPLIED, WITH RESPECT TO THIS DOCUMENT AND ANY RELATED OR ACCOMPANYING SOFTWARE OR HARDWARE, INCLUDING BUT NOT LIMITED TO THE IMPLIED WARRANTIES OF MERCHANTABILITY, OR FITNESS FOR A PARTICULAR PURPOSE.
 8. When using Renesas Electronics products, refer to the latest product information (data sheets, user's manuals, application notes, "General Notes for Handling and Using Semiconductor Devices" in the reliability handbook, etc.), and ensure that usage conditions are within the ranges specified by Renesas Electronics with respect to maximum ratings, operating power supply voltage range, heat dissipation characteristics, installation, etc. Renesas Electronics disclaims any and all liability for any malfunctions, failure or accident arising out of the use of Renesas Electronics products outside of such specified ranges.
 9. Although Renesas Electronics endeavors to improve the quality and reliability of Renesas Electronics products, semiconductor products have specific characteristics, such as the occurrence of failure at a certain rate and malfunctions under certain use conditions. Unless designated as a high reliability product or a product for harsh environments in a Renesas Electronics data sheet or other Renesas Electronics document, Renesas Electronics products are not subject to radiation resistance design. You are responsible for implementing safety measures to guard against the possibility of bodily injury, injury or damage caused by fire, and/or danger to the public in the event of a failure or malfunction of Renesas Electronics products, such as safety design for hardware and software, including but not limited to redundancy, fire control and malfunction prevention, appropriate treatment for aging degradation or any other appropriate measures. Because the evaluation of microcomputer software alone is very difficult and impractical, you are responsible for evaluating the safety of the final products or systems manufactured by you.
 10. Please contact a Renesas Electronics sales office for details as to environmental matters such as the environmental compatibility of each Renesas Electronics product. You are responsible for carefully and sufficiently investigating applicable laws and regulations that regulate the inclusion or use of controlled substances, including without limitation, the EU RoHS Directive, and using Renesas Electronics products in compliance with all these applicable laws and regulations. Renesas Electronics disclaims any and all liability for damages or losses occurring as a result of your noncompliance with applicable laws and regulations.
 11. Renesas Electronics products and technologies shall not be used for or incorporated into any products or systems whose manufacture, use, or sale is prohibited under any applicable domestic or foreign laws or regulations. You shall comply with any applicable export control laws and regulations promulgated and administered by the governments of any countries asserting jurisdiction over the parties or transactions.
 12. It is the responsibility of the buyer or distributor of Renesas Electronics products, or any other party who distributes, disposes of, or otherwise sells or transfers the product to a third party, to notify such third party in advance of the contents and conditions set forth in this document.
 13. This document shall not be reprinted, reproduced or duplicated in any form, in whole or in part, without prior written consent of Renesas Electronics.
 14. Please contact a Renesas Electronics sales office if you have any questions regarding the information contained in this document or Renesas Electronics products.
- (Note 1) "Renesas Electronics" as used in this document means Renesas Electronics Corporation and also includes its directly or indirectly controlled subsidiaries.
(Note 2) "Renesas Electronics product(s)" means any product developed or manufactured by or for Renesas Electronics.

(Rev.5.0-1 October 2020)

SALES OFFICES

Refer to "<http://www.renesas.com/>" for the latest and detailed information.

Renesas Electronics Corporation

TOYOSU FORESIA, 3-2-24 Toyosu, Koto-ku, Tokyo 135-0061, Japan

Renesas Electronics America Inc. Milpitas Campus

1001 Murphy Ranch Road, Milpitas, CA 95035, U.S.A.
Tel: +1-408-432-8888, Fax: +1-408-434-5351

Renesas Electronics America Inc. San Jose Campus

6024 Silver Creek Valley Road, San Jose, CA 95138, USA
Tel: +1-408-284-8200, Fax: +1-408-284-2775

Renesas Electronics Canada Limited

9251 Yonge Street, Suite 8309 Richmond Hill, Ontario Canada L4C 9T3
Tel: +1-905-237-2004

Renesas Electronics Europe GmbH

Arcadiastrasse 10, 40472 Düsseldorf, Germany
Tel: +49-211-6503-0, Fax: +49-211-6503-1327

Renesas Electronics (China) Co., Ltd.

Room 101-T01, Floor 1, Building 7, Yard No. 7, 8th Street, Shangdi, Haidian District, Beijing 100085, China
Tel: +86-10-8235-1155, Fax: +86-10-8235-7679

Renesas Electronics (Shanghai) Co., Ltd.

Unit 301, Tower A, Central Towers, 555 Langao Road, Putuo District, Shanghai 200333, China
Tel: +86-21-2226-0888, Fax: +86-21-2226-0999

Renesas Electronics Hong Kong Limited

Unit 1601-1611, 16/F., Tower 2, Grand Century Place, 193 Prince Edward Road West, Mongkok, Kowloon, Hong Kong
Tel: +852-2265-6688, Fax: +852-2866-9022

Renesas Electronics Taiwan Co., Ltd.

13F, No. 363, Fu Shing North Road, Taipei 10543, Taiwan
Tel: +886-2-8175-9600, Fax: +886-2-8175-9670

Renesas Electronics Singapore Pte. Ltd.

80 Bendemeer Road, #06-02 Singapore 339949
Tel: +65-6213-0200, Fax: +65-6213-0300

Renesas Electronics Malaysia Sdn.Bhd.

Unit No 3A-1 Level 3A Tower 8 UOA Business Park, No 1 Jalan Pengaturcara U1/51A, Seksyen U1, 40150 Shah Alam, Selangor, Malaysia
Tel: +60-3-5022-1288, Fax: +60-3-5022-1290

Renesas Electronics India Pvt. Ltd.

No.777C, 100 Feet Road, HAL 2nd Stage, Indiranagar, Bangalore 560 038, India
Tel: +91-80-67208700

Renesas Electronics Korea Co., Ltd.

17F, KAMCO Yangjae Tower, 262, Gangnam-daero, Gangnam-gu, Seoul, 06265 Korea
Tel: +82-2-558-3737, Fax: +82-2-558-5338