

EVM003

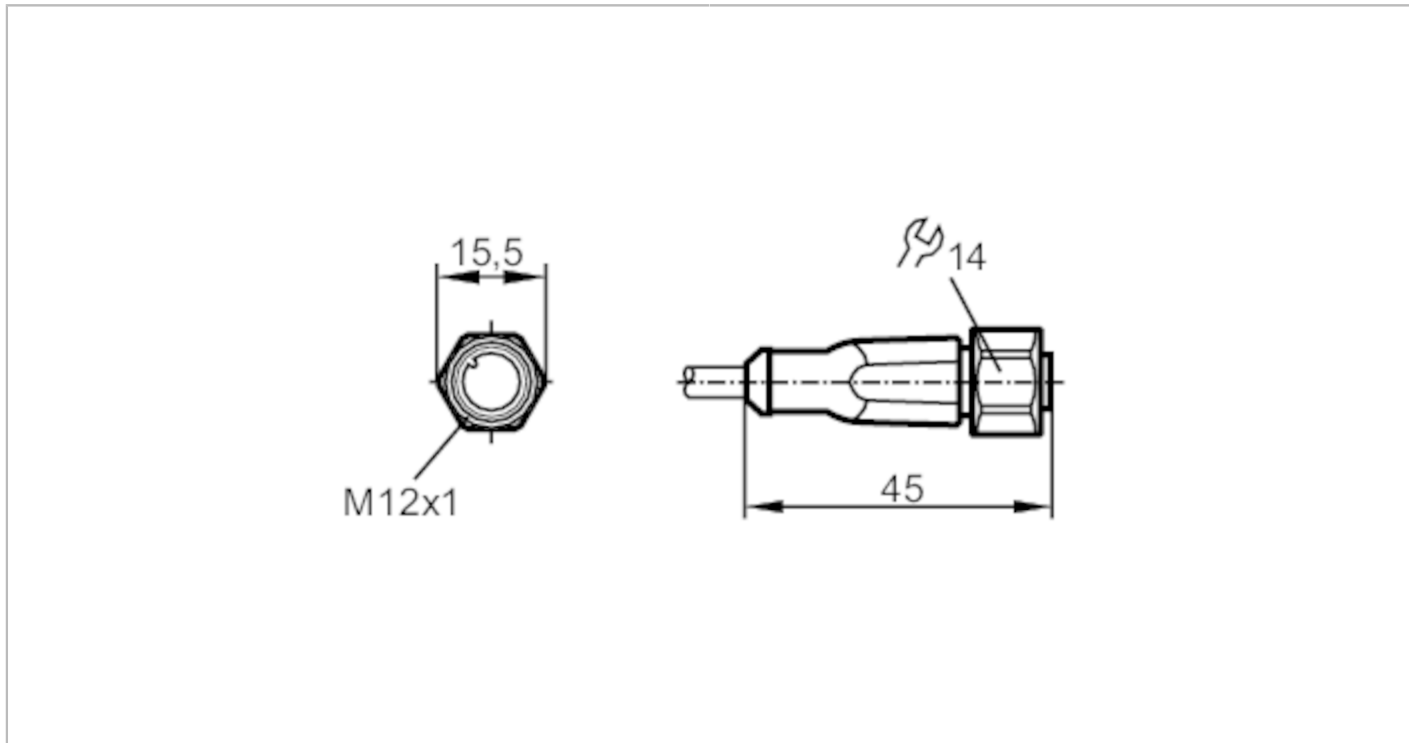

Connecting cable with socket

ADOGH040VAS0010H04



Application	
Special feature	Free from silicone; Halogen-free; Gold-plated contacts; Drag chain suitability
Application	applications in particularly harsh environments
Free from silicone	yes
Electrical data	
Operating voltage [V]	< 250 AC / < 300 DC
Protection class	II
Max. current load total [A]	4
Operating conditions	
Ambient temperature [°C]	-40...90
Note on ambient temperature	cULus: ...75
Ambient temperature (moving) [°C]	-25...90
Note on ambient temperature (moving)	cULus: ...75
Protection	IP 65; IP 67; IP 68; IP 69K

EVM003



Connecting cable with socket

ADOGH040VAS0010H04

Tests / approvals		
Vibration resistance	EN 60068-2-6 Fc	20 g (10...3000 Hz) / -20 °C / 50 °C 50 sweep cycles per frequency; 1 octave per minute in 3 axes
Shock resistance	EN 60068-2-27 Ea	100 g 11 ms half-sine; 6 shocks each in every direction along the three coordinate axes / -40 °C / 85 °C
Continuous shock resistance	EN 60068-2-29 Eb	40 g 6 ms; 4000 shocks each in every direction of the 3 coordinate axes / -20 °C / 50 °C
Fast temperature change	EN 60068-2-14 Na	TA = -40°C; TB = 85°C; t1 = 30 min; t2 = < 10 s 50 cycles
Salt spray test	EN 60068-2-52 Kb	severity level 5 (4 test cycles)

Mechanical data		
Weight [g]	337.8	
Dimensions [mm]	15.5 x 15.5 x 45	
Materials	housing: TPU orange; Sealing: FKM	
Material nut	stainless steel (1.4404 / 316L)	
Drag chain suitability	yes	
Drag chain suitability	bending radius for flexible use	min. 10 x cable diameter
	travel speed	max. 3.3 m/s for a horizontal travel length of 5 m and max. acceleration of 5 m/s ²
	bending cycles	> 5 Mio.
	torsional strain	± 180 °/m

Remarks	
Pack quantity	1 pcs.

Electrical connection
Cable: 10 m, PUR, Halogen-free, black, Ø 4.9 mm; 4 x 0.34 mm ² (42 x Ø 0.1 mm)

Electrical connection - socket
Connector: 1 x M12, straight; Locking: stainless steel (1.4404 / 316L); Contacts: gold-plated; Tightening torque: 0.6...1.5 Nm

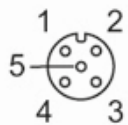



Connecting cable with socket

ADOGH040VAS0010H04

Connection



Core colours :

BK = black
BN = brown
BU = blue
WH = white

Diagrams and graphs

characteristic line for derating



Derating $I_{max} * 0.8$ (DIN EN 60512-5-2)

X Ambient temperature [°C]

Y Current [A]