

$V_{CES}$	1200V
$I_C$ (100°C)	15A
$V_{CE(sat)}$ (Typ.)	1.7V
$P_D$	267W

### ●Features

- 1) Low Collector - Emitter Saturation Voltage
- 2) Short Circuit Withstand Time 10 $\mu$ s
- 3) Qualified to AEC-Q101
- 4) Built in Very Fast & Soft Recovery FRD
- 5) Pb - free Lead Plating ; RoHS Compliant

### ●Application

General Inverter

for Automotive and Industrial Use

### ●Outline

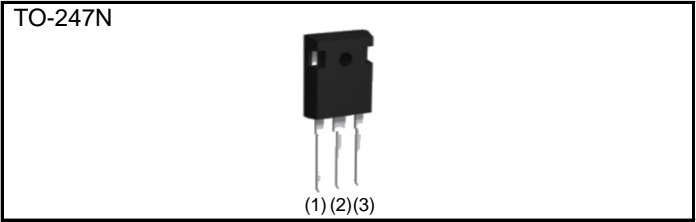

### ●Inner Circuit

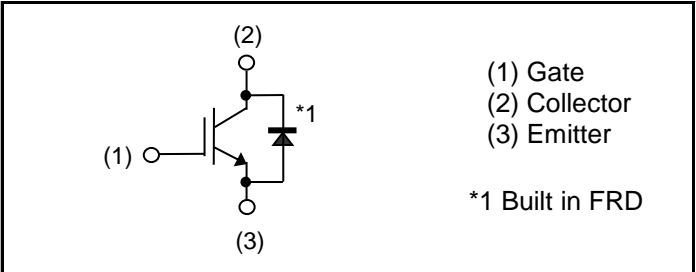

### ●Packaging Specifications

Type	Packaging	Tube
	Reel Size (mm)	-
	Tape Width (mm)	-
	Basic Ordering Unit (pcs)	450
	Packing Code	C11
	Marking	RGS30TSX2D

### ●Absolute Maximum Ratings (at $T_C = 25^\circ\text{C}$ unless otherwise specified)

Parameter	Symbol	Value	Unit
Collector - Emitter Voltage	$V_{CES}$	1200	V
Gate - Emitter Voltage	$V_{GES}$	$\pm 30$	V
Collector Current	$T_C = 25^\circ\text{C}$	$I_C$	30 A
	$T_C = 100^\circ\text{C}$	$I_C$	15 A
Pulsed Collector Current	$I_{CP}^{*1}$	45	A
Diode Forward Current	$T_C = 25^\circ\text{C}$	$I_F$	30 A
	$T_C = 100^\circ\text{C}$	$I_F$	15 A
Diode Pulsed Forward Current	$I_{FP}^{*1}$	45	A
Power Dissipation	$T_C = 25^\circ\text{C}$	$P_D$	267 W
	$T_C = 100^\circ\text{C}$	$P_D$	133 W
Operating Junction Temperature	$T_j$	-40 to +175	$^\circ\text{C}$
Storage Temperature	$T_{stg}$	-55 to +175	$^\circ\text{C}$

\*1 Pulse width limited by  $T_{jmax}$ .

### ●Thermal Resistance

Parameter	Symbol	Values			Unit
		Min.	Typ.	Max.	
Thermal Resistance IGBT Junction - Case	$R_{\theta(j-c)}$	-	-	0.56	°C/W
Thermal Resistance Diode Junction - Case	$R_{\theta(j-c)}$	-	-	1.10	°C/W

### ●IGBT Electrical Characteristics (at $T_j = 25^\circ\text{C}$ unless otherwise specified)

Parameter	Symbol	Conditions	Values			Unit
			Min.	Typ.	Max.	
Collector - Emitter Breakdown Voltage	$BV_{CES}$	$I_C = 10\mu\text{A}, V_{GE} = 0\text{V}$	1200	-	-	V
Collector Cut - off Current	$I_{CES}$	$V_{CE} = 1200\text{V}, V_{GE} = 0\text{V}$	-	-	10	$\mu\text{A}$
		$T_j = 175^\circ\text{C}^{*2}$	-	1	-	$\text{mA}$
Gate - Emitter Leakage Current	$I_{GES}$	$V_{GE} = \pm 30\text{V}, V_{CE} = 0\text{V}$	-	-	$\pm 500$	$\text{nA}$
Gate - Emitter Threshold Voltage	$V_{GE(th)}$	$V_{CE} = 5\text{V}, I_C = 2.3\text{mA}$	5.0	6.0	7.0	V
Collector - Emitter Saturation Voltage	$V_{CE(sat)}$	$I_C = 15\text{A}, V_{GE} = 15\text{V}$	-	1.70	2.10	V
		$T_j = 175^\circ\text{C}$	-	2.20	-	V

**●IGBT Electrical Characteristics (at  $T_j = 25^\circ\text{C}$  unless otherwise specified)**

Parameter	Symbol	Conditions	Values			Unit
			Min.	Typ.	Max.	
Input Capacitance	$C_{ies}$	$V_{CE} = 30\text{V}$	-	1272	-	pF
Output Capacitance	$C_{oes}$	$V_{GE} = 0\text{V}$	-	66	-	
Reverse transfer Capacitance	$C_{res}$	$f = 1\text{MHz}$	-	7.6	-	
Total Gate Charge	$Q_g$	$V_{CE} = 500\text{V}$	-	41	-	nC
Gate - Emitter Charge	$Q_{ge}$	$I_C = 15\text{A}$	-	11	-	
Gate - Collector Charge	$Q_{gc}$	$V_{GE} = 15\text{V}$	-	17	-	
Turn - on Delay Time	$t_{d(on)}$	$I_C = 15\text{A}, V_{CC} = 600\text{V},$ $V_{GE} = 15\text{V}, R_G = 10\Omega,$ $T_j = 25^\circ\text{C}$ Inductive Load * $E_{on}$ include diode reverse recovery	-	30	-	ns
Rise Time	$t_r$		-	8.5	-	
Turn - off Delay Time	$t_{d(off)}$		-	70	-	
Fall Time	$t_f$		-	128	-	
Turn-on Switching Loss	$E_{on}$		-	0.74	-	mJ
Turn-off Switching Loss	$E_{off}$		-	0.6	-	
Turn - on Delay Time	$t_{d(on)}$	$I_C = 15\text{A}, V_{CC} = 600\text{V},$ $V_{GE} = 15\text{V}, R_G = 10\Omega,$ $T_j = 175^\circ\text{C}$ Inductive Load * $E_{on}$ include diode reverse recovery	-	29	-	ns
Rise Time	$t_r$		-	10	-	
Turn - off Delay Time	$t_{d(off)}$		-	69	-	
Fall Time	$t_f$		-	120	-	
Turn-on Switching Loss	$E_{on}$		-	0.81	-	mJ
Turn-off Switching Loss	$E_{off}$		-	0.65	-	
Reverse Bias Safe Operating Area	RBSOA	$I_C = 45\text{A}, V_{CC} = 1050\text{V}$ $V_p = 1200\text{V}, V_{GE} = 15\text{V}$ $R_G = 50\Omega, T_j = 175^\circ\text{C}$	FULL SQUARE			-
Short Circuit Withstand Time	$t_{sc}$	$V_{CC} \leq 600\text{V}$ $V_{GE} = 15\text{V}, T_j = 25^\circ\text{C}$	10	-	-	$\mu\text{s}$
Short Circuit Withstand Time	$t_{sc}^{*2}$	$V_{CC} \leq 600\text{V}$ $V_{GE} = 15\text{V}, T_j = 150^\circ\text{C}$	8	-	-	$\mu\text{s}$

\*2 Design assurance without measurement

●FRD Electrical Characteristics (at  $T_j = 25^\circ\text{C}$  unless otherwise specified)

Parameter	Symbol	Conditions	Values			Unit
			Min.	Typ.	Max.	
Diode Forward Voltage	$V_F$	$I_F = 15\text{A}$ $T_j = 25^\circ\text{C}$	-	1.65	2.10	V
		$T_j = 175^\circ\text{C}$	-	1.85	-	
Diode Reverse Recovery Time	$t_{rr}$		-	157	-	ns
Diode Peak Reverse Recovery Current	$I_{rr}$	$I_F = 15\text{A}$ $V_{CC} = 600\text{V}$	-	12.8	-	A
Diode Reverse Recovery Charge	$Q_{rr}$	$di_F/dt = 500\text{A}/\mu\text{s}$ $T_j = 25^\circ\text{C}$	-	1.2	-	$\mu\text{C}$
Diode Reverse Recovery Energy	$E_{rr}$		-	281	-	$\mu\text{J}$
Diode Reverse Recovery Time	$t_{rr}$		-	257	-	ns
Diode Peak Reverse Recovery Current	$I_{rr}$	$I_F = 15\text{A}$ $V_{CC} = 600\text{V}$	-	15.4	-	A
Diode Reverse Recovery Charge	$Q_{rr}$	$di_F/dt = 500\text{A}/\mu\text{s}$ $T_j = 175^\circ\text{C}$	-	2.4	-	$\mu\text{C}$
Diode Reverse Recovery Energy	$E_{rr}$		-	775	-	$\mu\text{J}$

●Electrical Characteristic Curves

Fig.1 Power Dissipation vs. Case Temperature

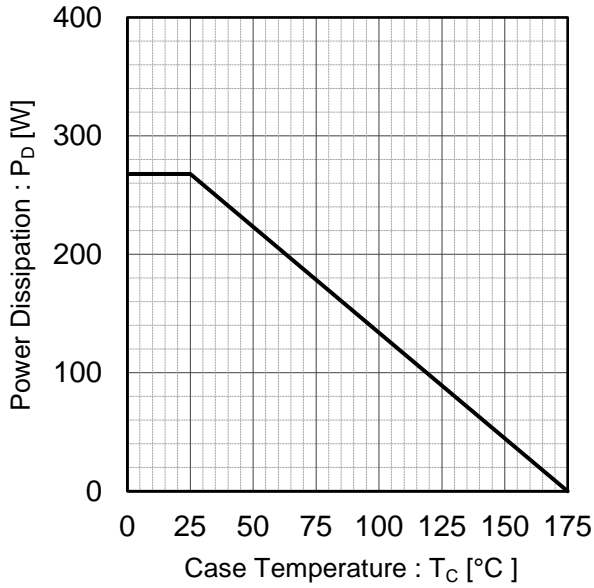

Fig.2 Collector Current vs. Case Temperature

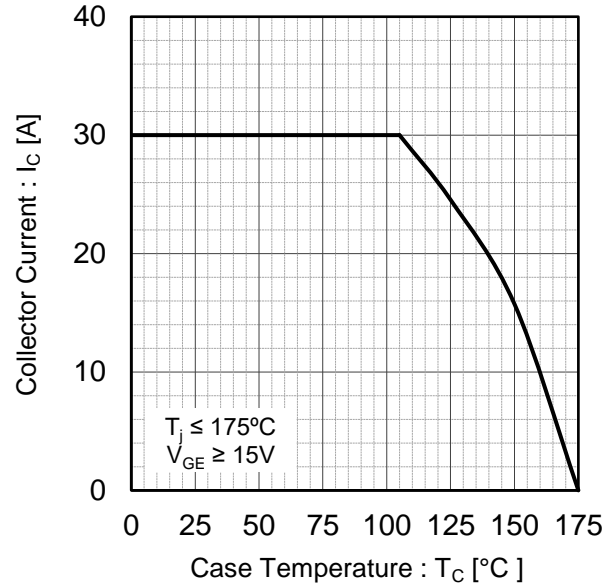

Fig.3 Forward Bias Safe Operating Area

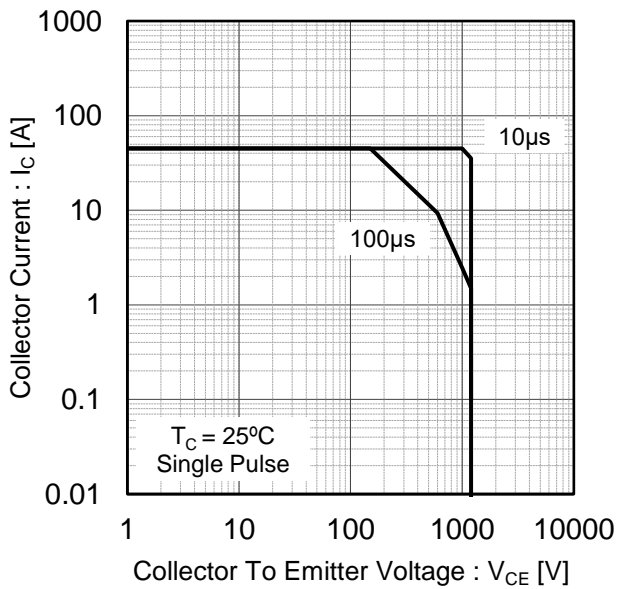
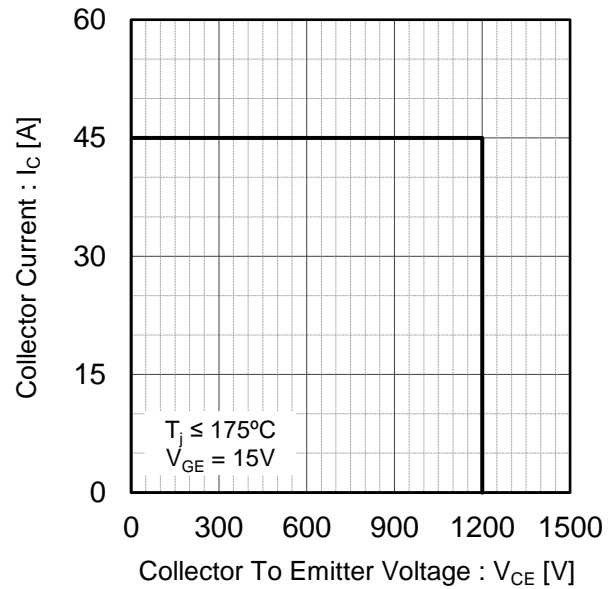

Fig.4 Reverse Bias Safe Operating Area



●Electrical Characteristic Curves

Fig.5 Typical Output Characteristics

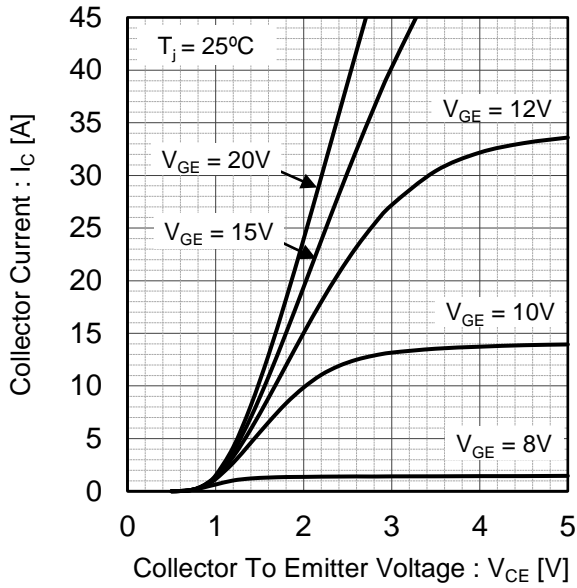

Fig.6 Typical Output Characteristics

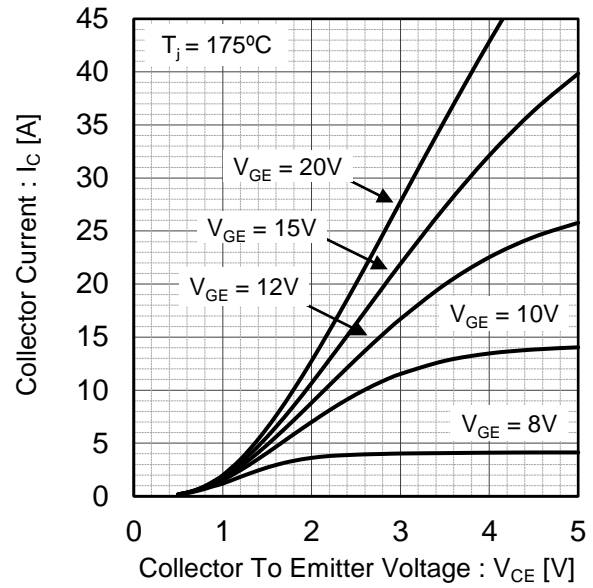

Fig.7 Typical Transfer Characteristics

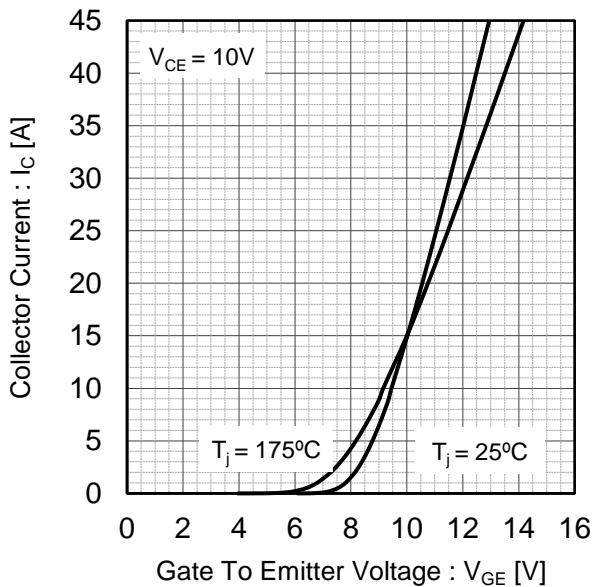
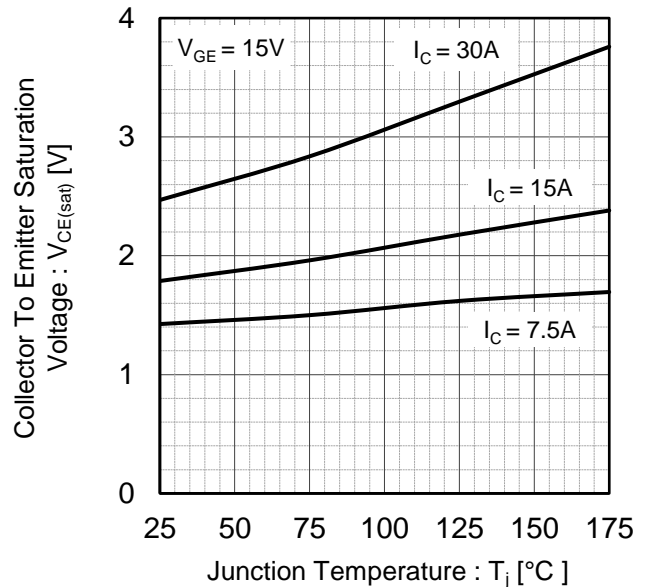

Fig.8 Typical Collector To Emitter Saturation Voltage vs. Junction Temperature



●Electrical Characteristic Curves

Fig.9 Typical Collector To Emitter Saturation Voltage vs. Gate To Emitter Voltage

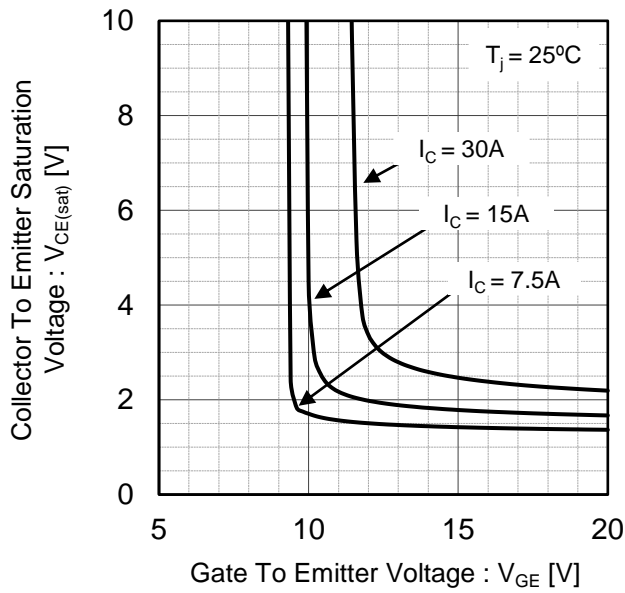

Fig.10 Typical Collector To Emitter Saturation Voltage vs. Gate To Emitter Voltage

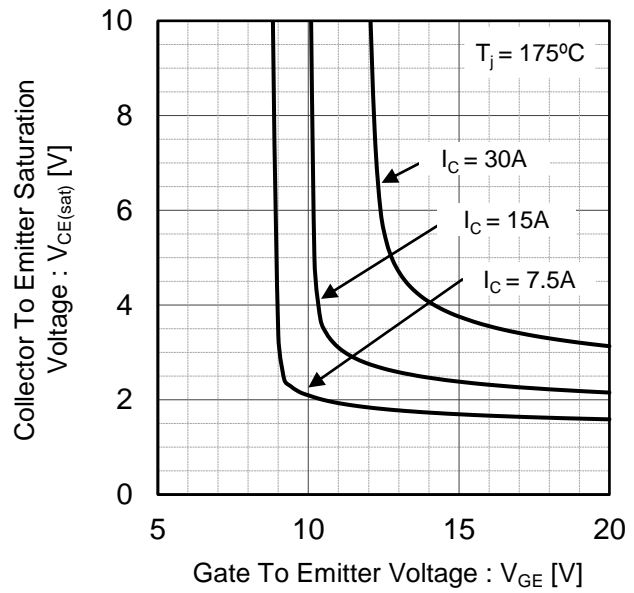

Fig.11 Typical Switching Time vs. Collector Current

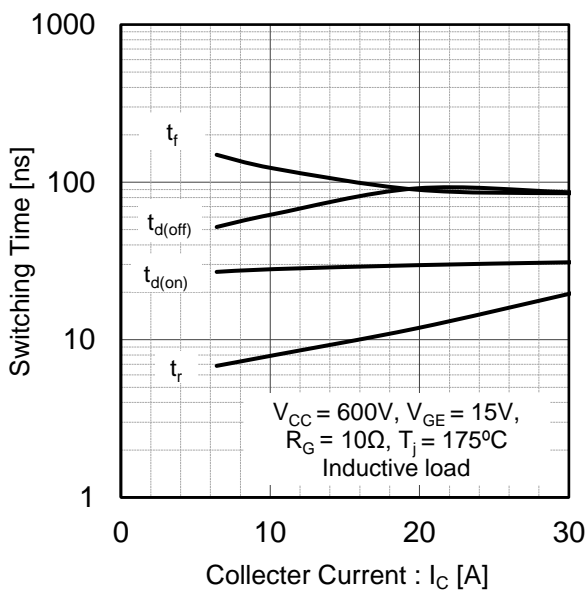
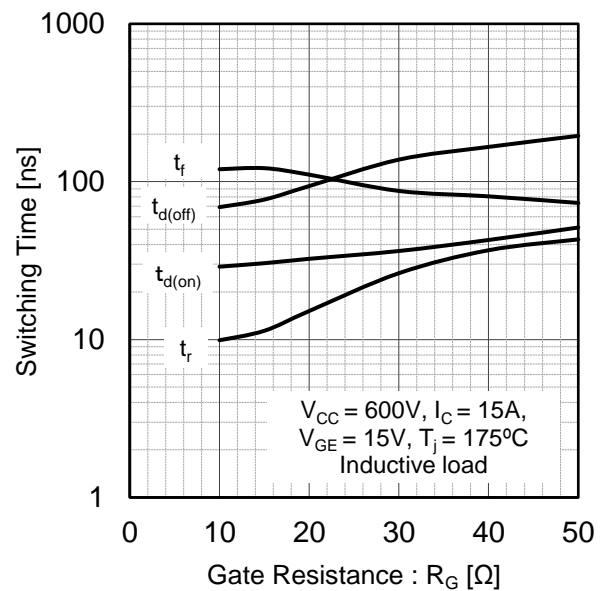

Fig.12 Typical Switching Time vs. Gate Resistance



●Electrical Characteristic Curves

Fig.13 Typical Switching Energy Losses vs. Collector Current

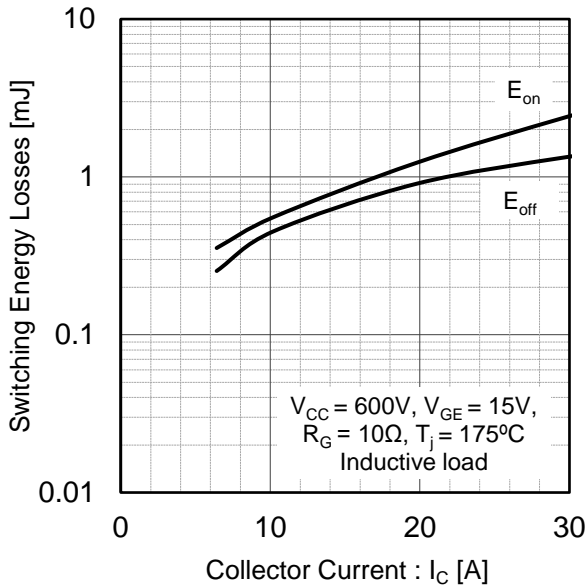

Fig.14 Typical Switching Energy Losses vs. Gate Resistance

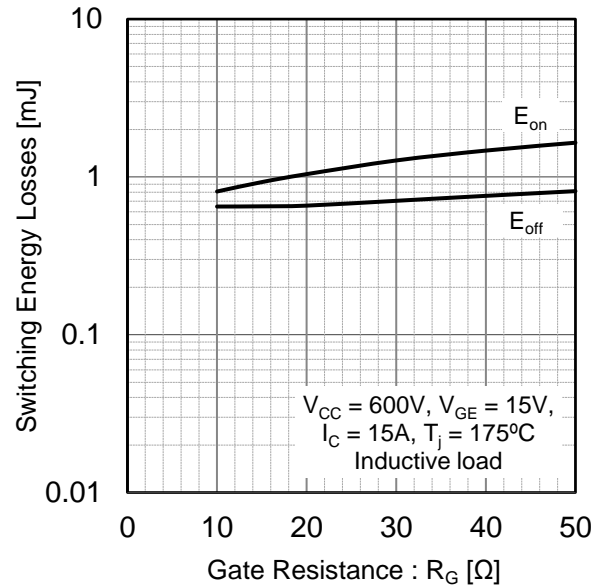

Fig.15 Typical Capacitance vs. Collector To Emitter Voltage

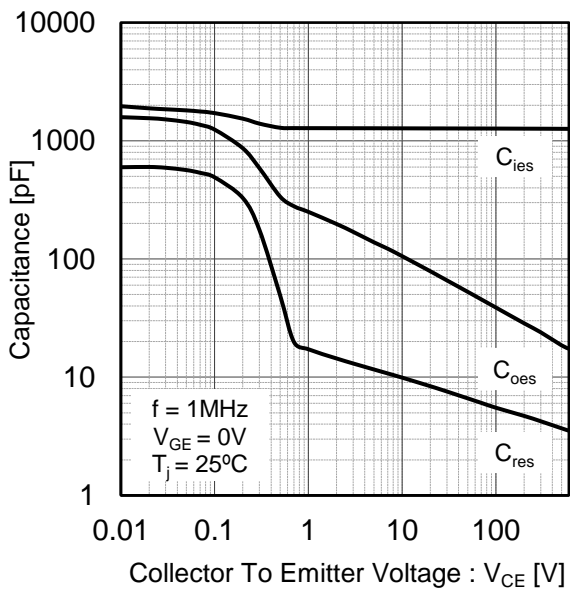
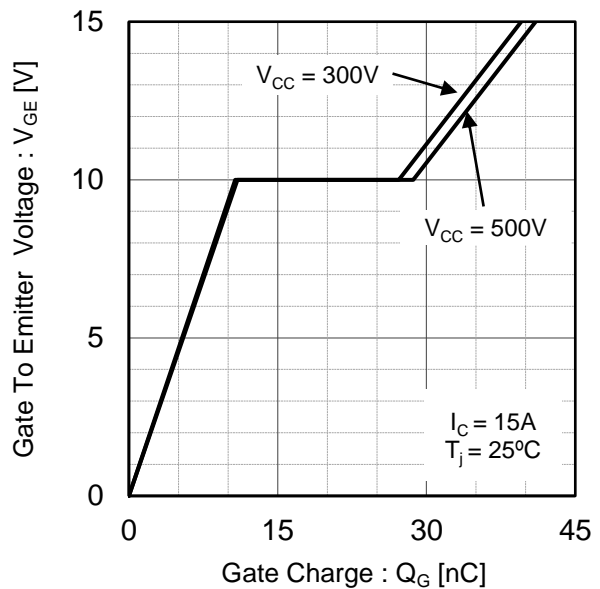

Fig.16 Typical Gate Charge





●Electrical Characteristic Curves

Fig.17 Typical Diode Forward Current vs. Forward Voltage

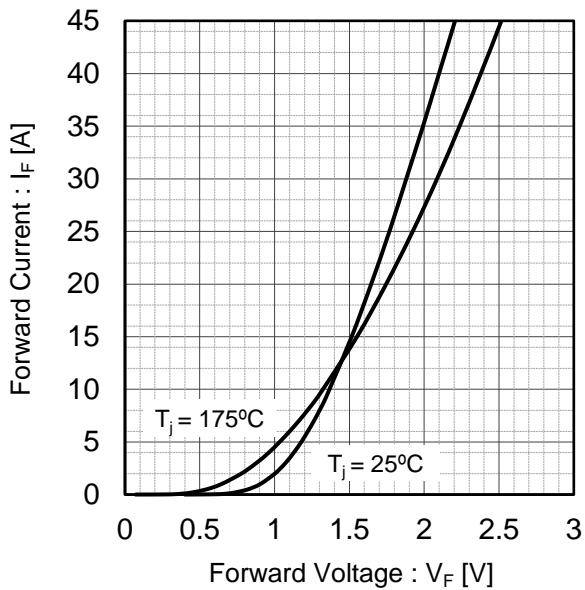

Fig.18 Typical Diode Reverse Recovery Time vs. Forward Current

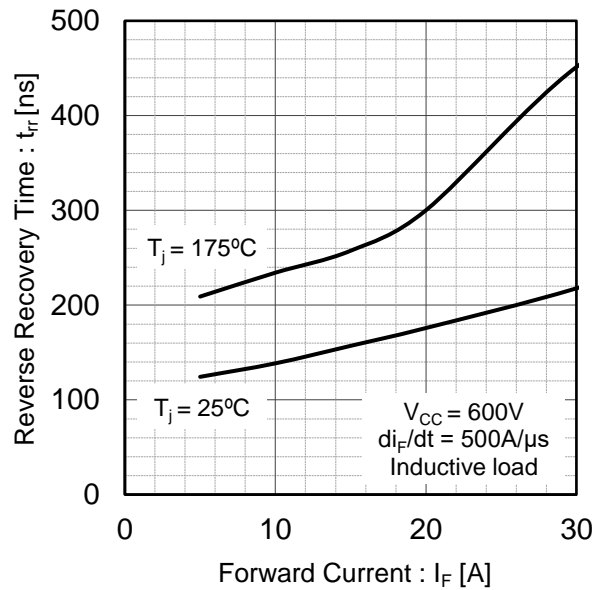

Fig.19 Typical Diode Reverse Recovery Current vs. Forward Current

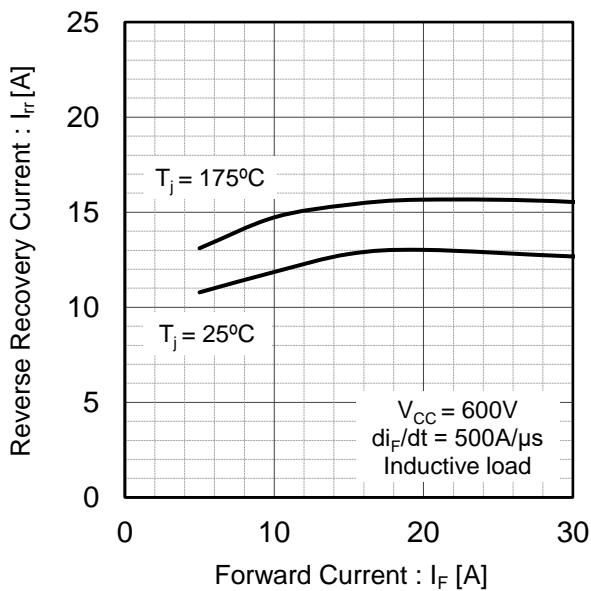
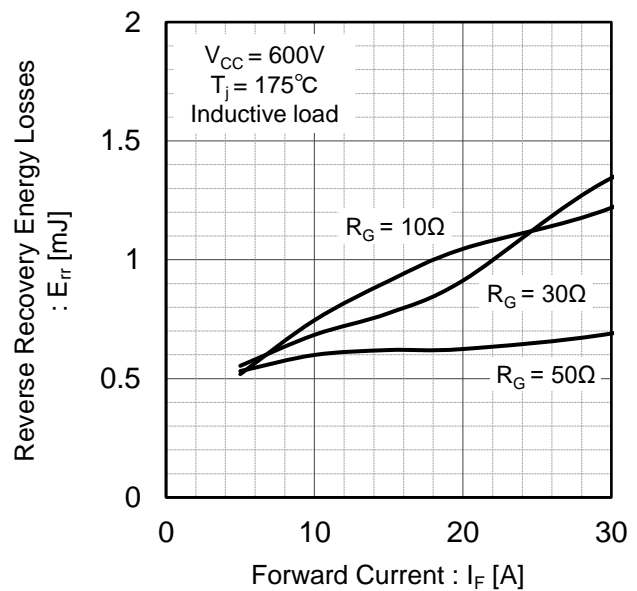

Fig.20 Typical Diode Reverse Recovery Energy Losses vs. Forward Current



●Electrical Characteristic Curves

Fig.21 IGBT Transient Thermal Impedance

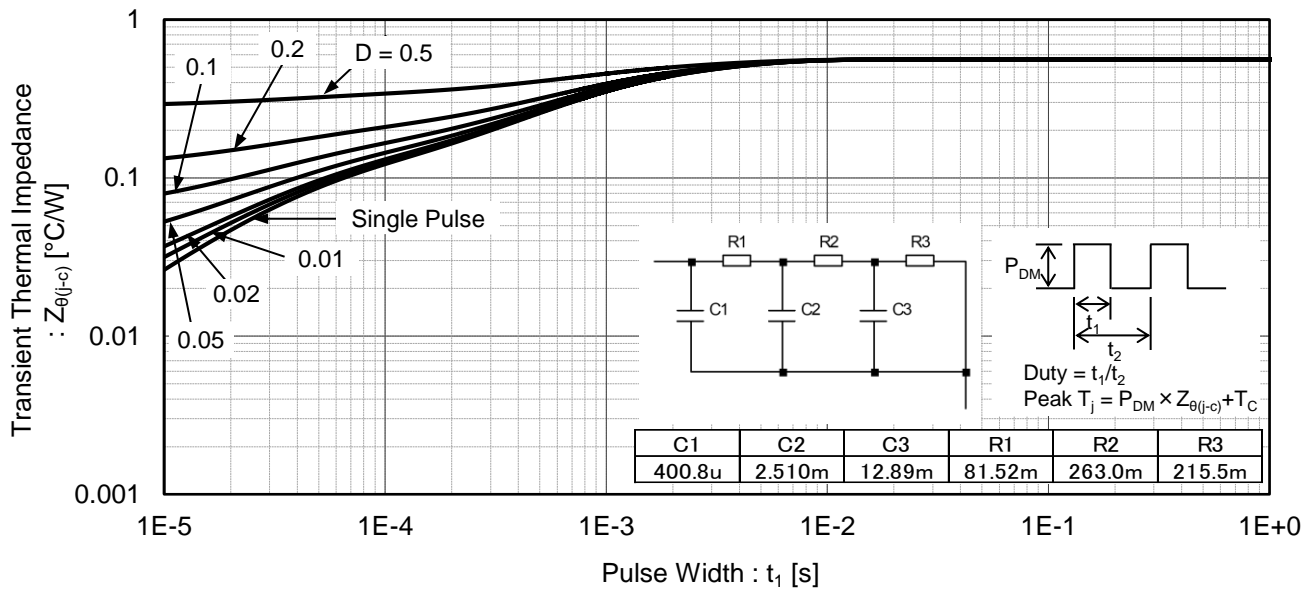
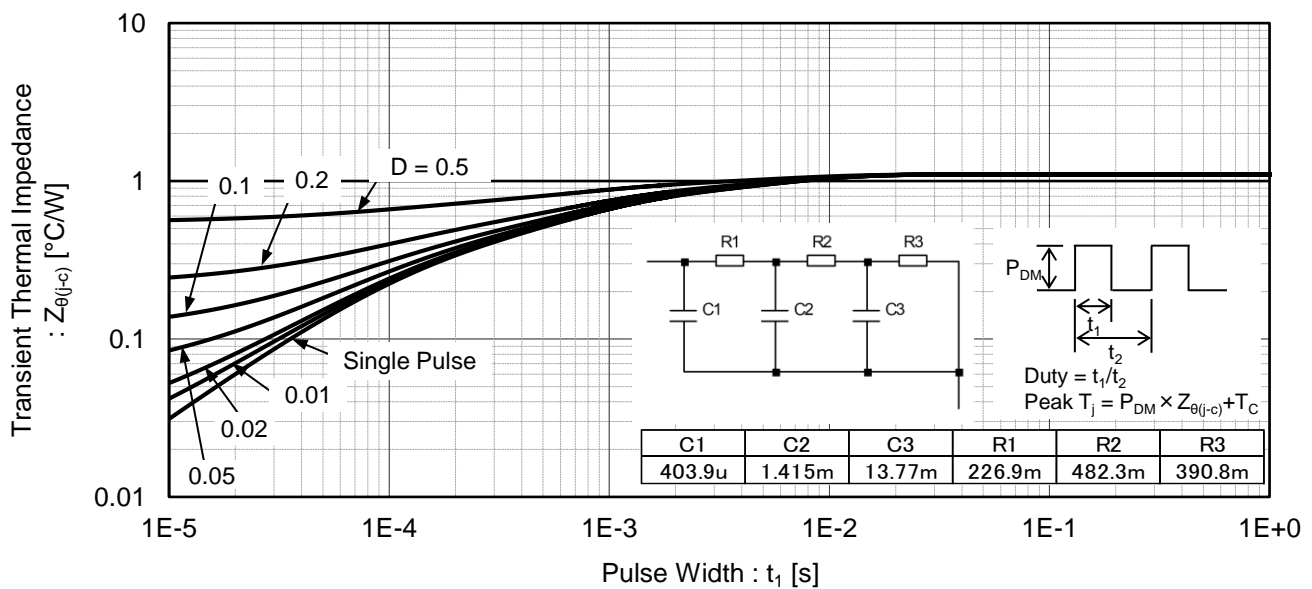

Fig.22 Diode Transient Thermal Impedance



● Inductive Load Switching Circuit and Waveform

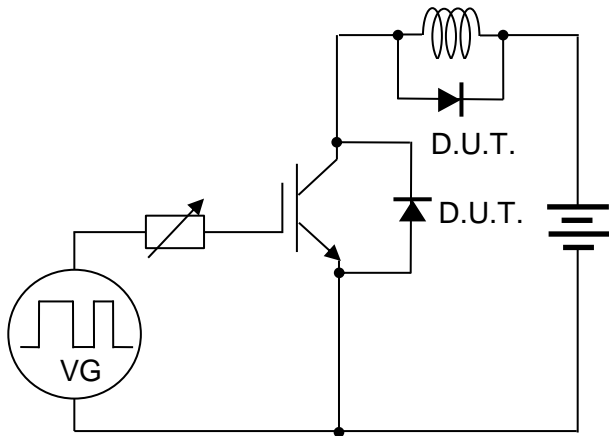

Fig.23 Inductive Load Circuit

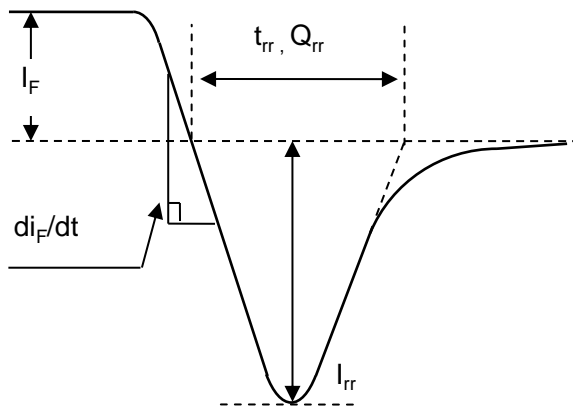

Fig.24 Diode Reverse Recovery Waveform

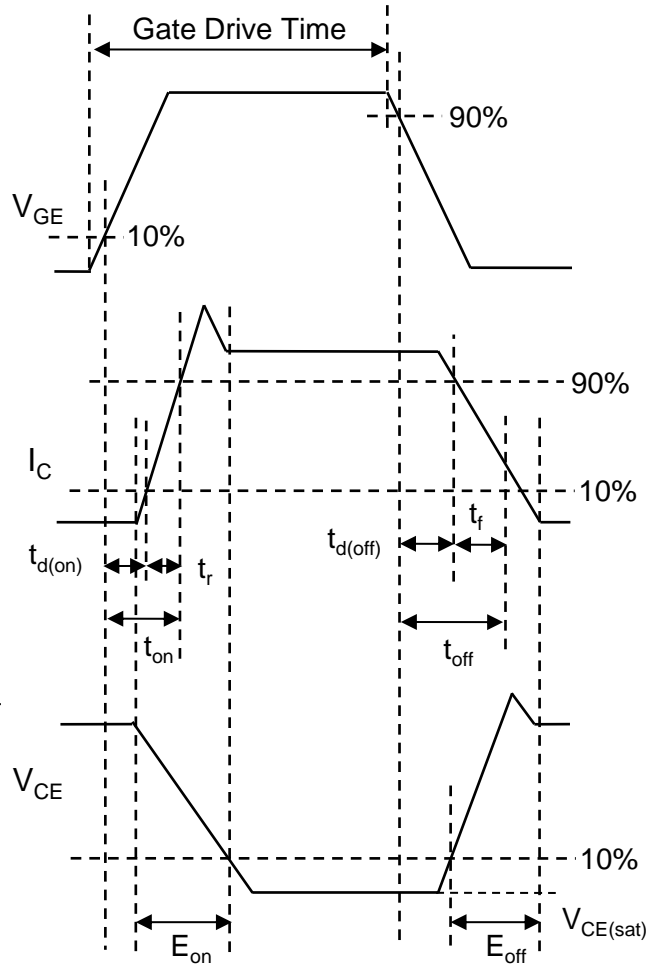

Fig.25 Inductive Load Waveform