

Thin Film Precision Chip Resistor 0805 Series

multicomp PRO

**RoHS
Compliant**

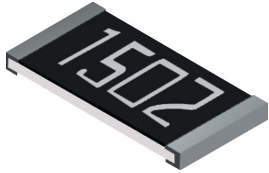

Features

- Advanced thin film technology
- Very tight tolerance down to $\pm 0.1\%$
- Extremely low TCR down to $\pm 5\text{PPM}/^\circ\text{C}$
- Wide resistance range 1Ω to $1\text{M}\Omega$

Applications

- Medical Equipment
- Testing / Measurement Equipment
- Printer Equipment
- Automatic Equipment Controller
- Converters
- Communication Device, Cell Phone, GPS, PDA

Construction

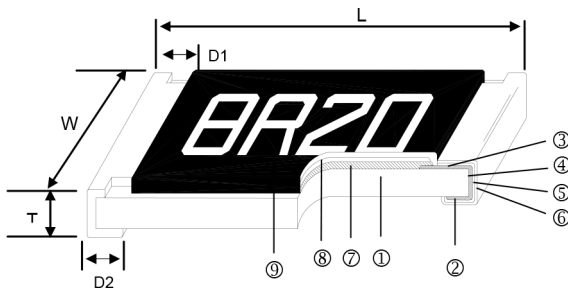

1	Alumina Substrate
2	Bottom Electrode (Ag)
3	Top Electrode (Ag-Pd)
4	Edge Electrode (NiCr)
5	Barrier Layer (Ni)
6	External Electrode (Sn)
7	Resistor Layer (NiCr)
8	Overcoat (Epoxy)
9	Marking

Dimensions

Type	Size (Inch)	L	W	T	D1	D2
MCTF	0805	2 ± 0.15	1.25 ± 0.15	0.55 ± 0.1	0.3 ± 0.2	0.4 ± 0.2

Dimensions : Millimetres

Derating Curve

Thin Film Precision Chip Resistor

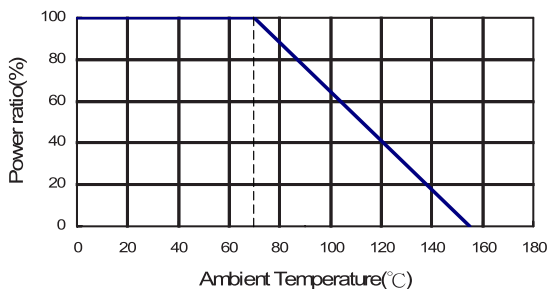

Newark.com/multicomp-pro
Farnell.com/multicomp-pro
Element14.com/multicomp-pro

multicomp PRO

Thin Film Precision Chip Resistor 0805 Series



Standard Electrical Specifications

Type \ Item	Power Rating at 70°C	Operating Temp. Range	Max. Operating Voltage	Max. Overload Voltage
MCTF0805	1/10W	-55°C to +155°C	100V	200V

Type \ Item	Resistance Range					TCR (PPM/°C)
	±0.05%	±0.1%	±0.25%	±0.5%	±1%	
MCTF0805	4.7Ω - 1MΩ	4.7Ω - 2MΩ	1Ω - 2MΩ			±25 ±50

Special Electrical Specifications

Type \ Item	Resistance Range						TCR (PPM/°C)
	±0.01%	±0.05%	±0.1%	±0.25%	±0.5%	±1%	
MCTF0805	24.9Ω to 30kΩ						±2 ±3 ±5
	24.9Ω to 200kΩ	4.7Ω to 1MΩ					±25 ±50

High Power Rating Electrical Specifications

Type \ Item	Resistance Range						TCR (PPM/°C)
	±0.01%	±0.05%	±0.1%	±0.25%	±0.5%	±1%	
MCTF0805	24.9Ω to 30kΩ						±2 ±3 ±5
	24.9Ω to 200kΩ	4.7Ω to 511kΩ	4.7Ω to 511kΩ				±10
			4.7Ω to 1MΩ				±15
			4.7Ω to 1MΩ	1Ω to 1MΩ			±25 ±50
	-	10Ω to 499kΩ					±25 ±50

Operating Voltage = $\sqrt{P \times R}$ or Max. operating voltage listed above, whichever is lower.

Overload Voltage = $2.5 \times \sqrt{P \times R}$ or Max. overload voltage listed above, whichever is lower.

Environmental Characteristics

Item	Requirement		Test Method
	Tol. ≤ 0.05%	Tol. > 0.05%	
Temperature Coefficient of Resistance (T.C.R.)	As Spec.		MIL-STD-202 Method 304 +25/-55/+25/+125/+25°C
Short Time Overload	ΔR±0.05%	ΔR±0.2%	JIS-C-5201-1 5.5 RCWV*2.5 or Max. overload voltage whichever is lower for 5 seconds
	ΔR±0.2% for high power rating		

Thin Film Precision Chip Resistor 0805 Series



Item	Requirement		Test Method
	Tol. $\leq 0.05\%$	Tol. $> 0.05\%$	
Insulation Resistance	$>1,000M\Omega$		MIL-STD-202 Method 302 Apply 100VDC for 1 minute
Endurance	$\Delta R \pm 0.05\%$	$\Delta R \pm 0.2\%$	MIL-STD-202 Method 108A 70 $\pm 2^\circ\text{C}$, RCWV for 1000 hrs with 1.5 hrs "ON" and 0.5 hrs "OFF"
	$>7k\Omega \Delta R \pm 0.5\%$		
	$\Delta R \pm 0.5\%$ for high power rating		
Damp Heat with Load	$\Delta R \pm 0.05\%$	$\Delta R \pm 0.3\%$	MIL-STD-202 Method 103B 40 $\pm 2^\circ\text{C}$, 90~95% R.H. RCWV for 1000 hrs with 1.5 $\Delta R \pm 0.5\%$ for high power rating hrs "ON" and 0.5 hrs "OFF"
	$\Delta R \pm 0.5\%$ for high power rating		
Bending Strength	$\Delta R \pm 0.05\%$	$\Delta R \pm 0.2\%$	JIS-C-5201-1 6.1.4 Bending amplitude 3 mm for 10 seconds
Solderability	95% min. coverage		MIL-STD-202 Method 208H 245 $\pm 5^\circ\text{C}$ for 3 seconds
Resistance to Soldering Heat	$\Delta R \pm 0.05\%$	$\Delta R \pm 0.2\%$	MIL-STD-202 Method 210E 260 $\pm 5^\circ\text{C}$ for 10 seconds
Dielectric Withstand Voltage	By Type		MIL-STD-202 Method 301 Max. overload voltage for 1 minute
Thermal Shock	$\Delta R \pm 0.05\%$	$\Delta R \pm 0.25\%$	MIL-STD-202 Method 107G -55 $^\circ\text{C}$ ~150 $^\circ\text{C}$, 100 cycles
Low Temperature Operation	$\Delta R \pm 0.05\%$	$\Delta R \pm 0.2\%$	JIS-C-5201-1 7.1 1 hour, -65 $^\circ\text{C}$, followed by 45 minutes of RCWV
	$\Delta R \pm 0.5\%$ for high power rating		

RCWV(Rated continuous working voltage) = $\sqrt{(P \cdot R)}$ or Max. Operating voltage whichever is lower

Storage Temperature: 25 $\pm 3^\circ\text{C}$; Humidity < 80%RH

Soldering Condition

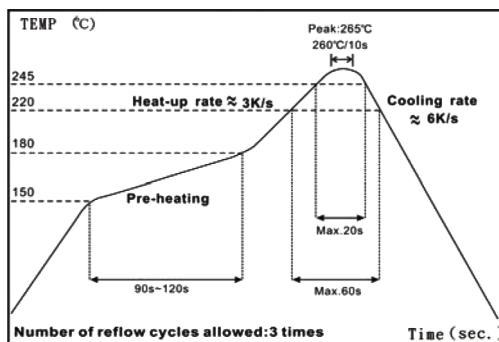

IR Reflow Soldering

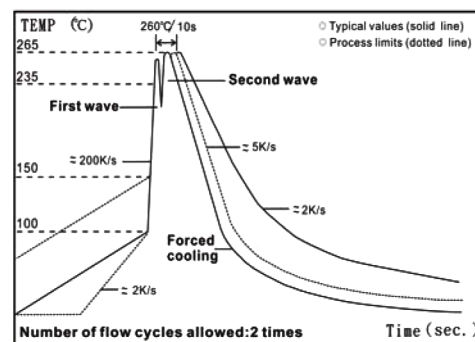

Wave Soldering (Flow Soldering)

(1) Time of IR reflow and wave soldering at maximum temperature point 260 $^\circ\text{C}$: 10s

(2) Time of soldering iron at maximum temperature point 410 $^\circ\text{C}$: 5s

Thin Film Precision Chip Resistor 0805 Series



Marking

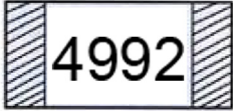

Example

Resistance	100Ω	2.2kΩ	10kΩ	49.9kΩ	100kΩ
Marking	1000	2201	1002	4992	1003

Packaging

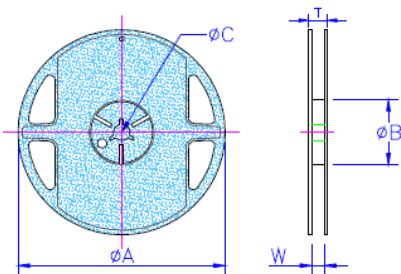

Packing Quantity & Real Specifications

Type	ØA	ØB	ØC	W	T	Paper Tape (EA)
MCTF0805	178 ±1	60 +1	13.5 ±0.7	9.5 ±1	11.5 ±1	5,000

Dimensions : Millimetres

Paper Tape Specifications

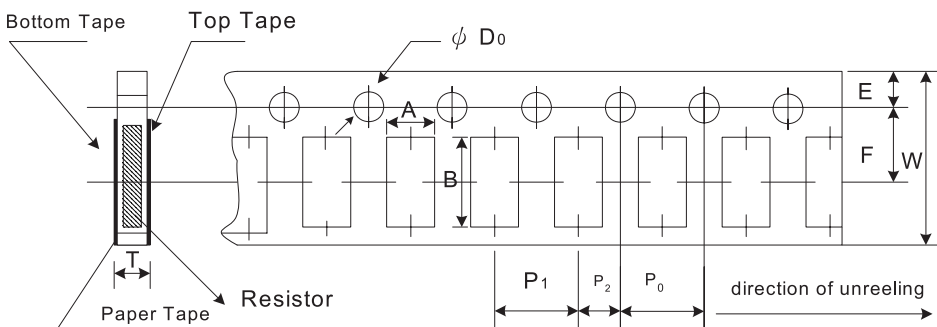

Type	A	B	w	E	F	P ₀	p ₁	p ₂	ΦD ₀	T
MCTF0805	1.6 ±0.05	2.37 ±0.05	8 ±0.1	1.75 ±0.05	3.5 ±0.05	4 ±0.1	4 ±0.1	2 ±0.05	1.55 ±0.05	0.75 ±0.05

Dimensions : Millimetres

Peel force of top cover tape

The peel speed shall be about 300mm/min ±5%

The peel force of top cover tape shall be between 8gf to 60gf

Thin Film Precision Chip Resistor 0805 Series

multicomp PRO

Recommend Land Pattern

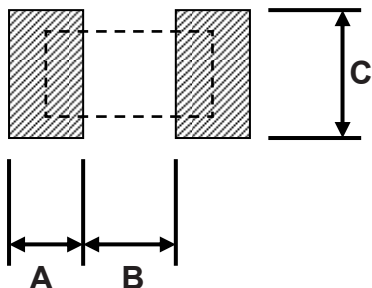

Type	A	B	C
MCTF0805	1mm	1mm	1.35mm ±0.2mm

Part Number Table

Description	Resistance	Resistance Tolerance	Voltage Range	Part Number
Thin Film Precision Chip Resistor 0805 Series	100Ω	±0.1%	100V	MCTF0805BTC1000
	1kΩ	±0.1%		MCTF0805BTC1001
	10kΩ	±0.1%		MCTF0805BTC1002
	100kΩ	±0.1%		MCTF0805BTC1003
	1MΩ	±0.1%		MCTF0805BTC1004
	12kΩ	±0.1%		MCTF0805BTC1202
	1.5kΩ	±0.1%		MCTF0805BTC1501
	15kΩ	±0.1%		MCTF0805BTC1502
	15kΩ	±0.1%		MCTF0805BTC1503
	2kΩ	±0.1%		MCTF0805BTC2001
	20kΩ	±0.1%		MCTF0805BTC2002
	200kΩ	±0.1%		MCTF0805BTC2003
	3kΩ	±0.1%		MCTF0805BTC3001
	4.99kΩ	±0.1%		MCTF0805BTC4991
	49.9kΩ	±0.1%		MCTF0805BTC4992
	100Ω	±0.5%		MCTF0805DTC1000
	1kΩ	±0.5%		MCTF0805DTC1001
	10kΩ	±0.5%		MCTF0805DTC1002
	100kΩ	±0.5%		MCTF0805DTC1003
	2kΩ	±0.5%		MCTF0805DTC2001
	49.9Ω	±0.5%		MCTF0805DTC49R9
	12kΩ	±0.05%		MCTF0805ATX1202
	1.5kΩ	±0.05%		MCTF0805ATX1501
	15kΩ	±0.05%		MCTF0805ATX1502
	150kΩ	±0.05%		MCTF0805ATX1503

Thin Film Precision Chip Resistor 0805 Series



Description	Resistance	Resistance Tolerance	Voltage Range	Part Number
Thin Film Precision Chip Resistor 0805 Series	20kΩ	±0.05%	100V	MCTF0805ATX2002
	200kΩ	±0.05%		MCTF0805ATX2003
	3kΩ	±0.05%		MCTF0805ATX3001
	499Ω	±0.05%		MCTF0805ATX499
	75Ω	±0.05%		MCTF0805ATX750
	12kΩ	±0.05%		MCTF0805ATY1202
	150kΩ	±0.05%		MCTF0805ATY1503
	2kΩ	±0.05%		MCTF0805ATY2001
	20kΩ	±0.05%		MCTF0805ATY2002
	200kΩ	±0.05%		MCTF0805ATY2003
	49.9Ω	±0.05%		MCTF0805ATY499
	4.99kΩ	±0.05%		MCTF0805ATY4991
	49.9kΩ	±0.05%		MCTF0805ATY4992
	12kΩ	±0.05%		MCTF0805ATZ1202
	15kΩ	±0.05%		MCTF0805ATZ1502
	2kΩ	±0.05%		MCTF0805ATZ2001
	20kΩ	±0.05%		MCTF0805ATZ2002
	49.9Ω	±0.05%		MCTF0805ATZ499
	100Ω	±0.01%		MCTF0805TTX1000
	1kΩ	±0.01%		MCTF0805TTX1001
	10kΩ	±0.01%		MCTF0805TTX1002
	100kΩ	±0.01%		MCTF0805TTX1003
	100Ω	±0.01%		MCTF0805TTY1000
	1kΩ	±0.01%		MCTF0805TTY1001
	10kΩ	±0.01%		MCTF0805TTY1002
	100kΩ	±0.01%		MCTF0805TTY1003
	100Ω	±0.01%		MCTF0805TTZ1000
	1kΩ	±0.01%		MCTF0805TTZ1001

Important Notice : This data sheet and its contents (the "Information") belong to the members of the AVNET group of companies (the "Group") or are licensed to it. No licence is granted for the use of it other than for information purposes in connection with the products to which it relates. No licence of any intellectual property rights is granted. The Information is subject to change without notice and replaces all data sheets previously supplied. The Information supplied is believed to be accurate but the Group assumes no responsibility for its accuracy or completeness, any error in or omission from it or for any use made of it. Users of this data sheet should check for themselves the Information and the suitability of the products for their purpose and not make any assumptions based on information included or omitted. Liability for loss or damage resulting from any reliance on the Information or use of it (including liability resulting from negligence or where the Group was aware of the possibility of such loss or damage arising) is excluded. This will not operate to limit or restrict the Group's liability for death or personal injury resulting from its negligence. Multicomp Pro is the registered trademark of Premier Farnell Limited 2019.

Newark.com/multicomp-pro
Farnell.com/multicomp-pro
Element14.com/multicomp-pro

