

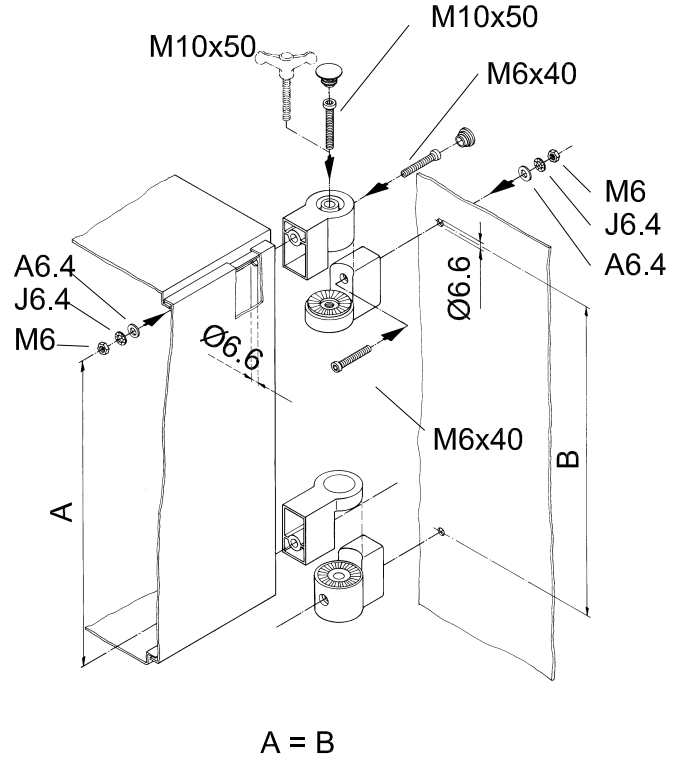

CP
6016.200

Raum für Verpackungsdatum
Area for date of packing
(MMJJTT / MMYDD)

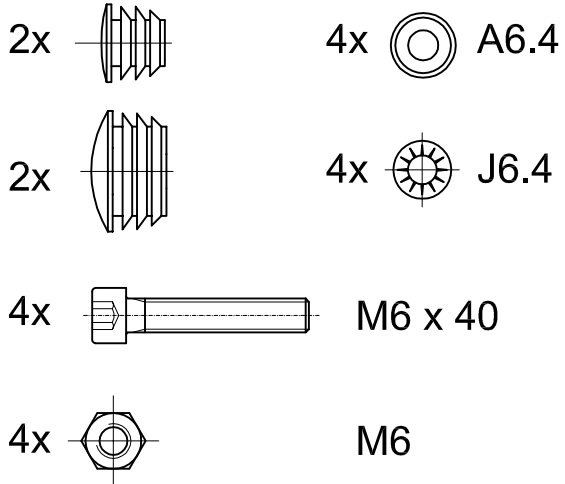

Zchnng.-Nr. / No. of dwg. : A2827201CP

Versandbeutel-Nr. / No. of accessory bag : 286931

Lieferanten-Nr. / No. of supplier :