

CLIFF

BLACK METAL FEEDTHROUGH CONNECTORS FT Series

The Black Metal FT Series of true feed through connectors are perfect for developing custom I/O configurations for wall-plates, rack panels, etc. ALL fit within a standard XLR panel cutout, and use common cabling for front and back connections. No soldering, no punch terminations, just use the standard cable for that particular connector style. Mount from the front or back, low rear profile accommodates the tightest "behind the panel" spaces. Available in a wide variety of styles. The frame has a matt black finish.

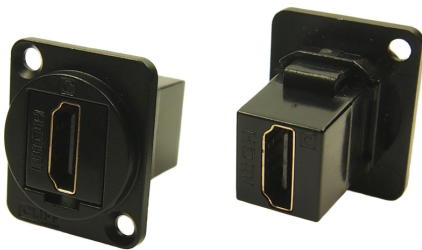
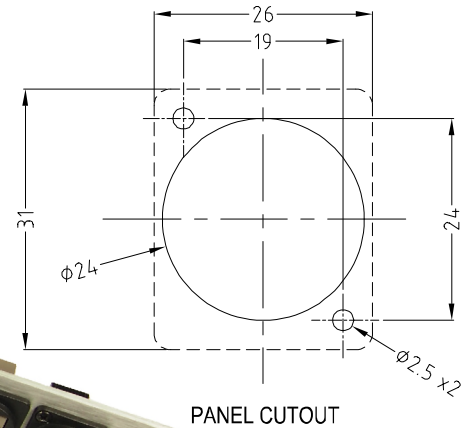
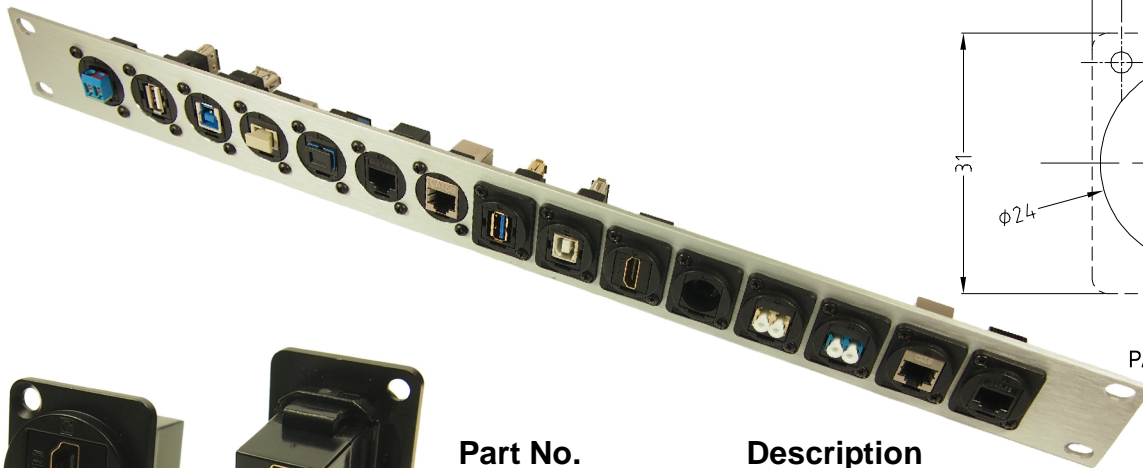

Part No.
CP30200GMB

Description
HDMI A Female to HDMI A, Gold Plated, CSK hole.



Part No.
CP30203NMB

Description
USB 2.0 B to USB 2.0 B, CSK hole.



Part No.
CP30204NMB

Description
USB 3.0 B to USB 3.0 B, CSK hole.



Part No.
CP30205NMB

Description
USB 3.0 A to USB 3.0 A, CSK hole.



Part No.
CP30206NMB

Description
USB 3.0 B to USB 3.0 A, CSK hole.



Part No.
CP30207NMB

Description
USB 2.0 B to USB 2.0 A, CSK hole.



Part No.
CP30208NMB

Description
USB 2.0 A to USB 2.0 A, CSK hole.

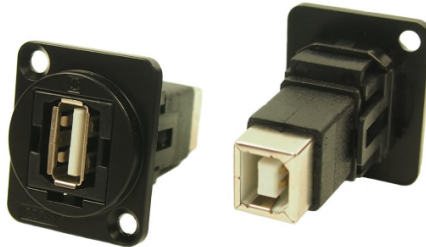

Part No.
CP30209NMB

Description
USB 2.0 A to USB 2.0 B, CSK hole.

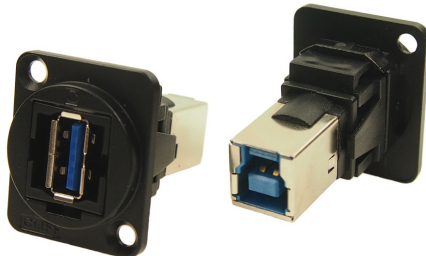

Part No.
CP30210NMB

Description
USB 3.0 A to USB 3.0 B, CSK hole.



Part No.
CP30211MB

Description
USB C Female to Male, CSK hole.



Part No.
CP30212MB

Description
Dual USB C Female to Male, CSK hole.

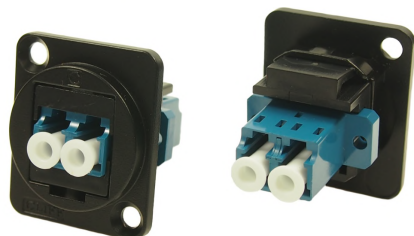

Part No.
CP30213MB

Description
LC Duplex SM adaptor, CSK Hole

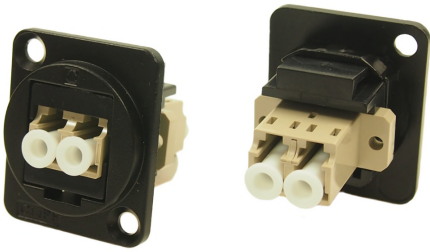

Part No.
CP30214MB

Description
LC Duplex MM, CSK Hole



Part No.
CP30215MB

Description
SC Simplex SM, CSK Hole

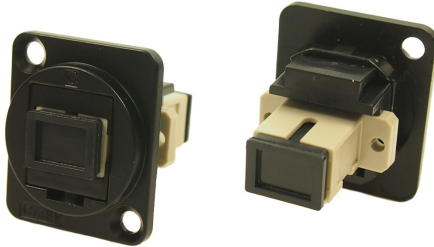

Part No.
CP30216MB

Description
SC Simplex MM, CSK Hole



Part No.
CP30217MB

Description
Toslink, CSK Hole

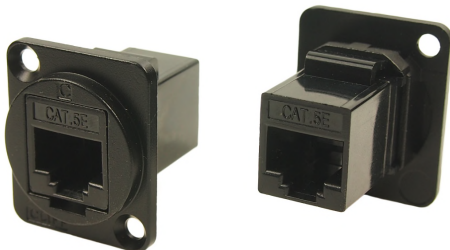

Part No.
CP30220MB

Description
UTP Cat5e RJ45-RJ45, CSK Hole



Part No.
CP30220SMB

Description
FTP Cat5e RJ45-RJ45, Shielded, CSK Hole



Part No.
CP30222MB

Description
UTP Cat6 RJ45-RJ45, CSK Hole



Part No.
CP30222SMB

Description
FTP Cat6 RJ45-RJ45, Shielded, CSK Hole



Part No.
CP30230MB

Description
RCA Phono RED, CSK Hole



Part No.
CP30231MB

Description
RCA Phono WHITE, CSK Hole



Part No.
CP30232MB

Description
RCA Phono YELLOW, CSK Hole

Other colours available on request.



Part No.
CP30241MB

Description
Blanking Plate, CSK Hole



Part No.
CP30114

Description
XLR USB A to USB B, CSK Hole



Part No.
CP30115

Description
XLR USB B to USB A, CSK Hole



Part No.
CP30120

Description
XLR 50 OHM BNC, CSK Hole

NEW



Part No.
CP30121

Description
XLR 75 OHM BNC, CSK Hole

NEW



Part No.
CP30122

Description
XLR HDMI A-A, CSK Hole

NEW



Part No.
CP30112

Description
Sealing Cover for CP30114, CP30115 and CP30122 only.

For further information, contact sales@cliffuk.co.uk

Cliff Electronic Components Limited

76 Holmethorpe Avenue, Holmethorpe Ind. Estate,
Redhill, Surrey RH1 2PF U.K.

Tel: +44 (0)1737 771375 Fax: +44 (0)1737 766012



Visit us online at:



www.cliffuk.co.uk