



- ⊕ IP68 rating tested at 1.054kg/sq cm (15lb/sq in) 10m depth for 2 weeks
- ⊕ IP69K, Tested in accordance with DIN 40050/Part 9 IP6k9k
- ⊕ 32A, 600V AC/DC rating
- ⊕ 2, 3, 4, 5, 7 and 10 Contact
- ⊕ Plug or socket connection in each body style
- ⊕ Water and dustproof to IP68 when mated
- ⊕ 'Scoop proof' contacts
- ⊕ Field termination - screw terminations
- ⊕ Positive locating keyways - cannot be mis-connected
- ⊕ Sealing caps available to maintain IP68 rating of unmated connectors
- ⊕ Leading earth contact for 3, 4, 5 and 7 Contact versions
- ⊕ EN60068-2-52 Test Kb Salt Mist (Cyclic) Marine Severity Level 1
- ⊕ Trailing Neutral on 5 Contact
- ⊕ Compact design
- ⊕ Easy assembly - no special tools required
- ⊕ Single or 3 phase applications
- ⊕ Bulkhead moulding available for use with flange mounting body for 45° or 90° mounting (order each separately)
- ⊕ Cost effective solution
- ⊕ Cable accommodation 7-22mm O/D
- ⊕ Two cable connector versions for 15mm and 22mm (maximum) cable diameters
- ⊕ Separate strain relief on large cable version
- ⊕ UL, CSA and VDE approvals

Flex Cable Connector



PX0911

Flex Cable Connector



PXA911

- Mates with Inline or panel mounting versions
- Positive, fast acting locking ring - can be turned with a gloved hand
- Plug or socket versions
- PX0 Series 13-15mm cable dia. as standard, 7-13mm with additional Gland Pack PX0980
- PXA Series 20-22mm cable dia. as standard, 14-20mm with additional Gland Pack PXA980
- Strain Relief Clamp

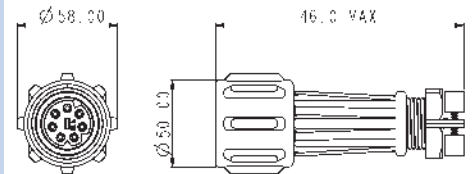
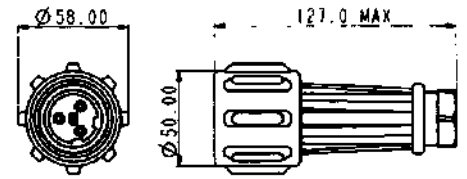

Standard Cable	Large Cable	Description	Standard Cable	Large Cable	Description
PX0911/02/P	PXA911/02/P	2 Contact Plug	PX0911/02/S	PXA911/02/S	2 Contact Socket
PX0911/03/P	PXA911/03/P	3 Contact Plug	PX0911/03/S	PXA911/03/S	3 Contact Socket
PX0911/04/P	PXA911/04/P	4 Contact Plug	PX0911/04/S	PXA911/04/S	4 Contact Socket
PX0911/05/P	PXA911/05/P	5 Contact Plug	PX0911/05/S	PXA911/05/S	5 Contact Socket
PX0911/07/P	PXA911/07/P	7 Contact Plug	PX0911/07/S	PXA911/07/S	7 Contact Socket
PX0911/10/P	PXA911/10/P	10 Contact Plug	PX0911/10/S	PXA911/10/S	10 Contact Socket

Inline Cable Connector



PX0921

Inline Cable Connector



PXA921

- Mates with either PX0911 or PXA911 connectors
- Plug or socket versions
- PX0 Series 13-15mm cable dia. as standard, 7-13mm with additional Gland Pack PX0980
- PXA Series 20-22mm cable dia. as standard, 14-20mm with additional Gland Pack PXA980
- Strain Relief Clamp

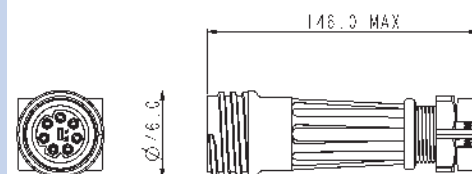
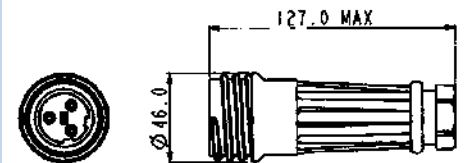

Standard Cable	Large Cable	Description	Standard Cable	Large Cable	Description
PX0921/02/P	PXA921/02/P	2 Contact Plug	PX0921/02/S	PXA921/02/S	2 Contact Socket
PX0921/03/P	PXA921/03/P	3 Contact Plug	PX0921/03/S	PXA921/03/S	3 Contact Socket
PX0921/04/P	PXA921/04/P	4 Contact Plug	PX0921/04/S	PXA921/04/S	4 Contact Socket
PX0921/05/P	PXA921/05/P	5 Contact Plug	PX0921/05/S	PXA921/05/S	5 Contact Socket
PX0921/07/P	PXA921/07/P	7 Contact Plug	PX0921/07/S	PXA921/07/S	7 Contact Socket
PX0921/10/P	PXA921/10/P	10 Contact Plug	PX0921/10/S	PXA921/10/S	10 Contact Socket

Front Panel Mounted Connector



PX0931

- Mates with PX0911 and PXA911 connectors
- Single hole fixing
- Anti-rotation key
- High grade sealing gasket
- 3-7mm panel thickness

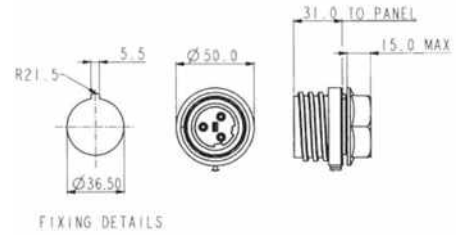

Panel Mounting

PX0931/02/P	2 Contact Plug	PX0931/02/S	2 Contact Socket
PX0931/03/P	3 Contact Plug	PX0931/03/S	3 Contact Socket
PX0931/04/P	4 Contact Plug	PX0931/04/S	4 Contact Socket
PX0931/05/P	5 Contact Plug	PX0931/05/S	5 Contact Socket
PX0931/07/P	7 Contact Plug	PX0931/07/S	7 Contact Socket
PX0931/10/P	10 Contact Plug	PX0931/10/S	10 Contact Socket

Flange Mounted Connector



PX0941

- Mates with PX0911 and PXA911 connectors
- Supplied with high grade sealing gasket
- Supplied with sealing grommets for panel fixing screws (M6 thread recommended)

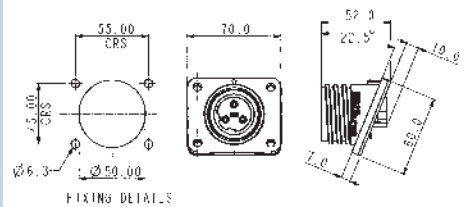

Flange Mounting

PX0941/02/P	2 Contact Plug	PX0941/02/S	2 Contact Socket
PX0941/03/P	3 Contact Plug	PX0941/03/S	3 Contact Socket
PX0941/04/P	4 Contact Plug	PX0941/04/S	4 Contact Socket
PX0941/05/P	5 Contact Plug	PX0941/05/S	5 Contact Socket
PX0941/07/P	7 Contact Plug	PX0941/07/S	7 Contact Socket
PX0941/10/P	10 Contact Plug	PX0941/10/S	10 Contact Socket

Additional Bulkhead Adaptor Moulding



PX0950

Additional Bulkhead Adaptor Moulding



PX0950 & PX0941

- For use with flange mounting connector PX0941, to give 45° or 90° angle
- Supplied with high grade sealing gasket
- Supplied with sealing grommets for panel fixing screws (M6 thread recommended)

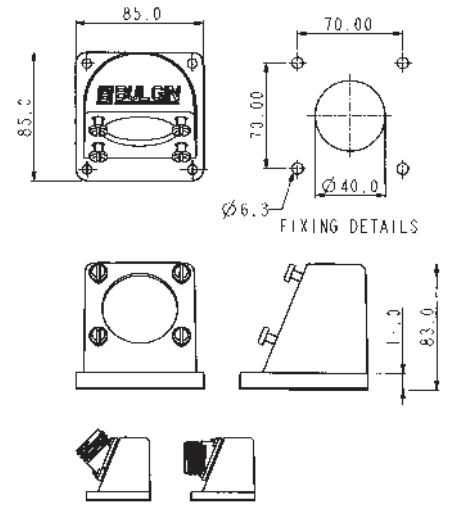

Sealing Caps



PX0960, PX0970, PX0990, PX0991, PX0992

- Sealing caps to maintain IP68 rating of unmated connectors, with plastic straps
- Heavy duty sealing caps to maintain IP68 rating of unmated connectors, with stainless steel straps

Sealing Caps

- PX0960 Sealing cap for use with PX0911/xx/x and PXA911/xx/x
- PX0970 Sealing cap for use with all other styles
- PX0990 Heavy duty sealing cap for use with PX0911/xx/x and PXA911/xx/x
- PX0991 Heavy duty sealing cap for use with PX0921/xx/x and PXA921/xx/x
- PX0992 Heavy duty sealing cap for use with PX0931W and PX0941

Cable Glands



PX0980, PXA980

- Packs of 3 additional pairs Cable Glands

Gland Packs

- PX0980 Pack of 3 additional cable glands for PX0911 and PX0921 to suit cable sizes: 7-9mm (dark grey), 9-11mm (white) and 11-13mm (Black) diameter
- PXA980 Pack of 3 additional cable glands for PXA911 and PXA921 to suit cable sizes: 14-16mm (dark grey), 16-18mm (white) and 18-20mm (black) diameter

BUCCANEER FOR POWER

900 Series Buccaneer

Specifications



Electrical

No Contacts:	2, 3	4, 5	7	10†
Current Rating:	32A 30A, CSA	32A 25A, CSA	32A 25A, CSA*	10A UL
Voltage Rating:	600V AC/DC	600V AC/DC	430V AC/DC	250V AC/DC
Contact Resistance:	<10m Ω (initial)			
Insulation Resistance:	>10 ⁹ MΩ (@ 500V DC)			
Dielectric strength:	2.2kV AC min			
AC Breakdown voltage:	6kV			
Operating Temperature Range:	-40°C to +85°C			
Approvals:	<ul style="list-style-type: none"> UL (Underwriters Laboratory) E214972 CSA (Canadian Standards Association) 1211899 VDE (Verband der Elektrotechnik) 40003148 			
	*with 75°C min. rated cable			

Material

Body Mouldings:	Polyamide
Flammability Rating:	UL94V-0
UV Resistance:	To EN50021: 1999
Contacts:	Machined Solid Brass, Nickel plated
O Rings:	Nitrile
Panel Sealing Gasket:	Silicone Rubber
RoHS	Compliant

Contact Layout

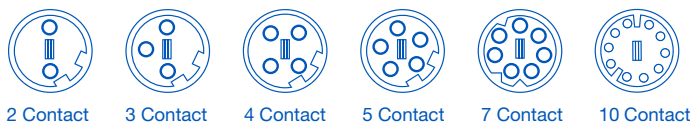

Dimensions

Overall dimensions of connectors when mated together

PX0911 + PX0921 230 mm max.
PXA911 + PXA921 270 mm max.

PX0911 + PX0931 135 mm max. (to panel)
PXA911 + PX0931 175 mm max. (to panel)

PX0911 + PX0941 145 mm max.
(to panel, mid point on flange)

PXA911 + PX0941 174 mm max.
(to panel, mid point on flange)

Mechanical:

Sealing:	IP69K, Tested in accordance with DIN 40050/Part 9 IP6K9K. IP68, EN60529:1992+A2:2013 tested @ 1.054kg/sq.cm. (15lb/sq.in.) 10m depth for 2 weeks
Salt Mist:	EN60068-2-52 Test Kb Salt Mist (Cyclic) Marine Severity Level 1
Cable Acceptance:	PX0911-PX0921 13 - 15mm O/D standard, 7-13mm with gland pack PX0980 PXA911-PXA921 20 - 22mm O/D standard, 14 - 20mm with gland pack PXA980
Contact Accommodation:	2-7 Contact - 2.5 to 4mm ² (14 to 10AWG) conductor, single or multi stranded 10 Contact - 0.75 to 2.5mm ² (14 to 18AWG) conductor, single or multi stranded

Termination: Axial screw terminals

Cable Retention force: 22mm dia, 150N
15mm dia, 150N
7mm dia, 80N

Gland Nut Torques:

PX0 range	
13-15mm (Yellow - std.)	3.16Nm (28 lbf.in.)
11-13mm (black)	3.16Nm (28 lbf.in.)
7-9mm (dark grey)	3.16Nm (28 lbf.in.)
PXA range	
20-22mm (Yellow - std.)	3.16Nm (28 lbf.in.)
18-20mm (black)	3.16Nm (28 lbf.in.)
16-18mm (white)	3.16Nm (28 lbf.in.)
14-16mm (dark grey)	3.16Nm (28 lbf.in.)

Tightening Torques:

Panel mount nut	2.25Nm (20 lbf.in.)
Flange & Bulkhead fixing screws	0.9Nm (8 lbf.in.)
Inserts into Bodies	1.13Nm (10 lbf.in.) to 1.36Nm (12 lbf.in.)
Term screws - 2 to 5 Contacts	1.0Nm (9 lbf.in.) max
Term screws - 7 Contact	0.4Nm (3.5 lbf.in.) max
Term screws - 10 Contact	0.25Nm (2.2 lbf.in.) max

Rear thread PX0931 series M36 x 2-6g

