

# MSA-2111

## Cascadable Silicon Bipolar MMIC Amplifier



### Data Sheet

#### Description

The MSA-2111 is a low cost silicon bipolar Monolithic Microwave Integrated Circuit (MMIC) housed in a surface mount plastic SOT-143 package. This MMIC is designed for use as a general purpose 50  $\Omega$  gain block. Typical applications include narrow and broad band IF and RF amplifiers in commercial and industrial applications.

The MSA-series is fabricated using Avago's 10 GHz  $f_T$ , 25 GHz  $f_{MAX}$ , silicon bipolar MMIC process which uses nitride self-alignment, ion implantation, and gold metallization to achieve excellent performance, uniformity and reliability. The use of an external bias resistor for temperature and current stability also allows bias flexibility.

#### Features

- Cascadable 50  $\Omega$  Gain Block
- Medium Power: 10 dBm at 900 MHz
- High Gain: 16.5 dB Typical at 900 MHz
- Low Noise Figure: 3.3 dB Typical at 900 MHz
- Low Cost Surface Mount Plastic Package
- Tape-and-Reel Packaging Option Available
- Lead-free Option Available

#### SOT-143 Package

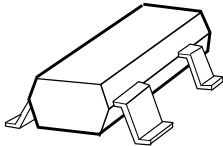

#### Pin Connections and Package Marking

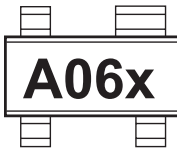

#### Notes:

Top View. Package Marking provides orientation and identification. "x" is the date code.

#### Typical Biasing Configuration

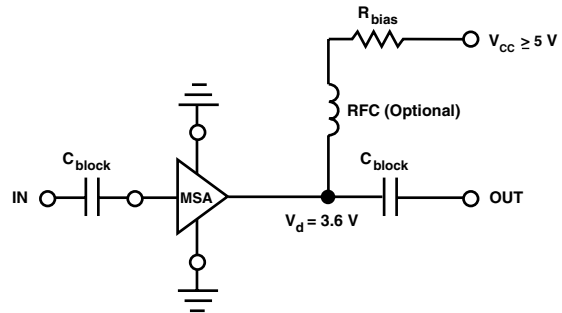

## MSA-2111 Absolute Maximum Ratings

Parameter	Absolute Maximum <sup>[1]</sup>
Device Current	40 mA
Power Dissipation <sup>[2,3]</sup>	125 mW
RF Input Power	+13 dBm
Junction Temperature	150°C
Storage Temperature	-65°C to 150°C

<b>Thermal Resistance<sup>[2]</sup>:</b> $\theta_{jc} = 505^{\circ}\text{C}/\text{W}$
--

### Notes:

1. Permanent damage may occur if any of these limits are exceeded.
2.  $T_{\text{CASE}} = 25^{\circ}\text{C}$ .
3. Derate at 2.0 mW/°C for  $T_{\text{C}} > 85^{\circ}\text{C}$ .

## Electrical Specifications<sup>[1]</sup>, $T_{\text{A}} = 25^{\circ}\text{C}$

Symbol	Parameters and Test Conditions: $I_{\text{d}} = 29 \text{ mA}$ , $Z_0 = 50 \Omega$	Units	Min.	Typ.	Max.
$G_{\text{P}}$	Power Gain ( $ S_{21} ^2$ ) $f = 900 \text{ MHz}$	dB	16.0	17.5	
$\Delta G_{\text{P}}$	Gain Flatness $f = 0.1 \text{ to } 0.3 \text{ GHz}$	dB		$\pm 0.5$	
$f_{3 \text{ dB}}$	3 dB Bandwidth	GHz		0.5	
VSWR	Input VSWR $f = 0.1 \text{ to } 2.5 \text{ GHz}$			1.8:1	
	Output VSWR $f = 0.1 \text{ to } 2.5 \text{ GHz}$			1.8:1	
NF	50 $\Omega$ Noise Figure $f = 900 \text{ MHz}$	dB		3.3	
$P_{1 \text{ dB}}$	Output Power at 1 dB Gain Compression $f = 900 \text{ MHz}$	dBm		10	
$\text{IP}_3$	Third Order Intercept Point $f = 900 \text{ MHz}$	dBm		20	
$t_{\text{D}}$	Group Delay $f = 900 \text{ MHz}$	psec		158	
$V_{\text{d}}$	Device Voltage	V	2.9	3.6	4.3
dV/dT	Device Voltage Temperature Coefficient	mV/°C		-8.0	

### Notes:

1. The recommended operating current range for this device is 12 to 35 mA. Typical gain performance as a function of current is on the following page.

## Ordering Information

Part Numbers	No. of Devices	Comments
MSA-2111-BLK	100	Bulk
MSA-2111-BLKG	100	Bulk
MSA-2111-TR1	3000	7" Reel
MSA-2111-TR1G	3000	7" Reel
MSA-2111-TR2	10000	13" Reel
MSA-2111-TR2G	10000	13" Reel

**Note:** Order part number with a "G" suffix if lead-free option is desired.

**MSA-2111 Typical Scattering Parameters ( $Z_0 = 50 \Omega$ ,  $T_A = 25^\circ\text{C}$ ,  $I_d = 29 \text{ mA}$ )**

Freq. GHz	$S_{11}$		$S_{21}$			$S_{12}$			$S_{22}$		k
	Mag	Ang	dB	Mag	Ang	dB	Mag	Ang	Mag	Ang	
0.1	.28	171	23.0	14.1	167	-26.0	.050	9	.27	177	1.03
0.2	.26	163	22.5	13.4	156	-25.5	.053	18	.27	175	1.03
0.3	.24	156	21.9	12.5	145	-24.9	.057	25	.26	173	1.03
0.4	.21	152	21.2	11.5	136	-24.0	.063	30	.26	171	1.03
0.5	.18	149	20.5	10.6	128	-23.4	.068	35	.24	170	1.03
0.6	.15	148	19.7	9.7	120	-22.6	.074	38	.24	169	1.03
0.7	.13	148	19.0	8.9	114	-21.8	.081	40	.22	169	1.04
0.8	.11	152	18.3	8.2	108	-21.1	.088	42	.21	169	1.04
0.9	.09	158	17.6	7.6	102	-20.4	.095	43	.20	168	1.04
1.0	.07	169	16.9	7.0	98	-19.9	.101	44	.19	169	1.05
1.5	.08	-123	14.0	5.0	79	-17.3	.136	45	.10	179	1.06
2.0	.11	-124	11.8	3.9	63	-15.5	.167	42	.06	-147	1.08
2.5	.15	-167	10.1	3.2	56	-14.3	.193	43	.06	-177	1.10
3.0	.27	158	8.3	2.6	43	-13.5	.211	38	.12	149	1.13
3.5	.38	145	6.8	2.2	32	-13.1	.222	34	.16	145	1.14
4.0	.46	135	5.6	1.9	21	-12.6	.234	30	.17	144	1.14

**Typical Performance,  $T_A = 25^\circ\text{C}$**

(unless otherwise noted)

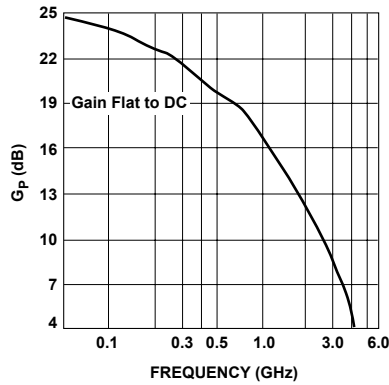

Figure 1. Power Gain vs. Frequency,  $I_d = 29 \text{ mA}$ .

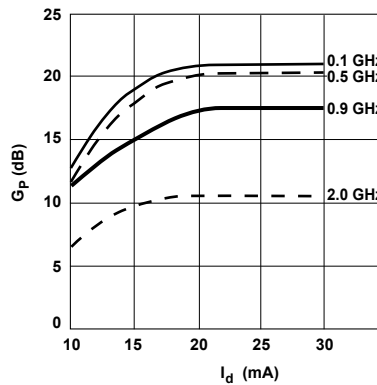

Figure 2. Power Gain vs. Current.

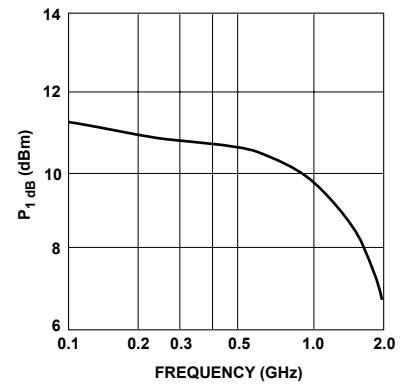

Figure 3. Output Power at 1 dB Gain Compression vs. Frequency,  $I_d = 29 \text{ mA}$ .

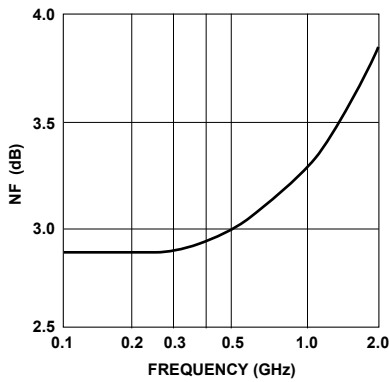
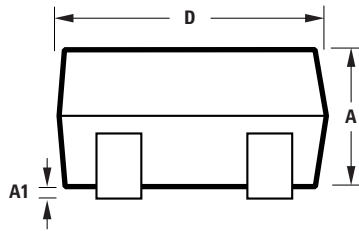
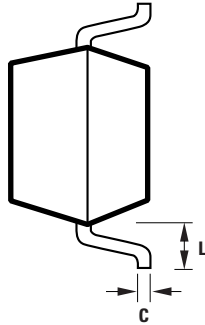
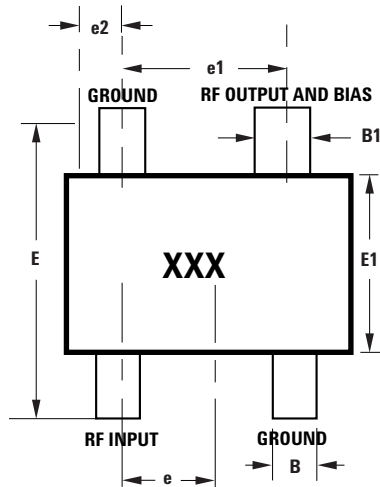

Figure 4. Noise Figure vs. Frequency,  $I_d = 29 \text{ mA}$ .

## SOT-143 Package Dimensions



Notes:  
 XXX-package marking  
 Drawings are not to scale

SYMBOL	DIMENSIONS (mm)	
	MIN.	MAX.
A	0.79	1.097
A1	0.013	0.10
B	0.36	0.54
B1	0.76	0.92
C	0.086	0.152
D	2.80	3.06
E1	1.20	1.40
e	0.89	1.02
e1	1.78	2.04
e2	0.45	0.60
E	2.10	2.65
L	0.45	0.69

For product information and a complete list of distributors, please go to our web site: [www.avagotech.com](http://www.avagotech.com)

Avago, Avago Technologies, and the A logo are trademarks of Avago Technologies, Limited in the United States and other countries. Data subject to change. Copyright © 2006 Avago Technologies, Limited. All rights reserved. Obsoletes 5989-4455EN AV02-0792EN - October 30, 2007

