

**We care for
your environment.**

Fume Extraction Solutions



Weller[®]FT
FILTER SYSTEMS



Content

Why Fume Extraction?	4
Solutions for clean air	5
Filter Technology	6
Filter Process	7
Volume Extraction	8
Volume Extraction Units	9–17
Volume Extraction / Technical Data	10–11
Installation Options	18
Clean Bench Concept CBC-A	19
Acryl Exhaust Cabinets	20
Extraction Hood	21
Fume Extraction / Pressure Drop	22
Easy-Click 60 Extraction Arms	23–26
Volume Extraction Accessories	27–32
Extraction Units Accessories	33
Tip Extraction	34
Tip Extraction Units	35–38
Tip Extraction Accessories	39–43
Pipe Systems	44
Tip Extraction Installation Options	45
Accessories Filters	46–51

Why Fume Extraction?

Many work environments today, including soldering and adhesives application, create particles and gases that can be harmful to the work place and the environment. Most people think that the move to leadfree soldering would be more nature friendly. In reality leadfree soldering smoke emissions contain more breathable fine dust particles. More smaller particles are produced due to higher working temperatures required and because more flux is used in the soldering process.

In many countries legal regulations governing clean air in the work place require that hazardous substances are removed from the air in order to avoid harmful effects on people and machines.

It is important to use the correct safety equipment to remove these hazardous substances. Inhaling fine particles is more dangerous than big particles as these get caught more easily and block the alveoli in the lungs.

To protect the operator it is important to use an extraction system that is able to separate these particles and gases and then re-circulates the cleaned air back into the work place. This also saves energy and reduces energy costs.

- > The smaller particles are, the deeper they penetrate into the respiratory system
- > The deeper particles penetrate, the higher are the health risks
- > The smallest particles travel via alveoli into the bloodstream

Fine dust accumulation in the human body

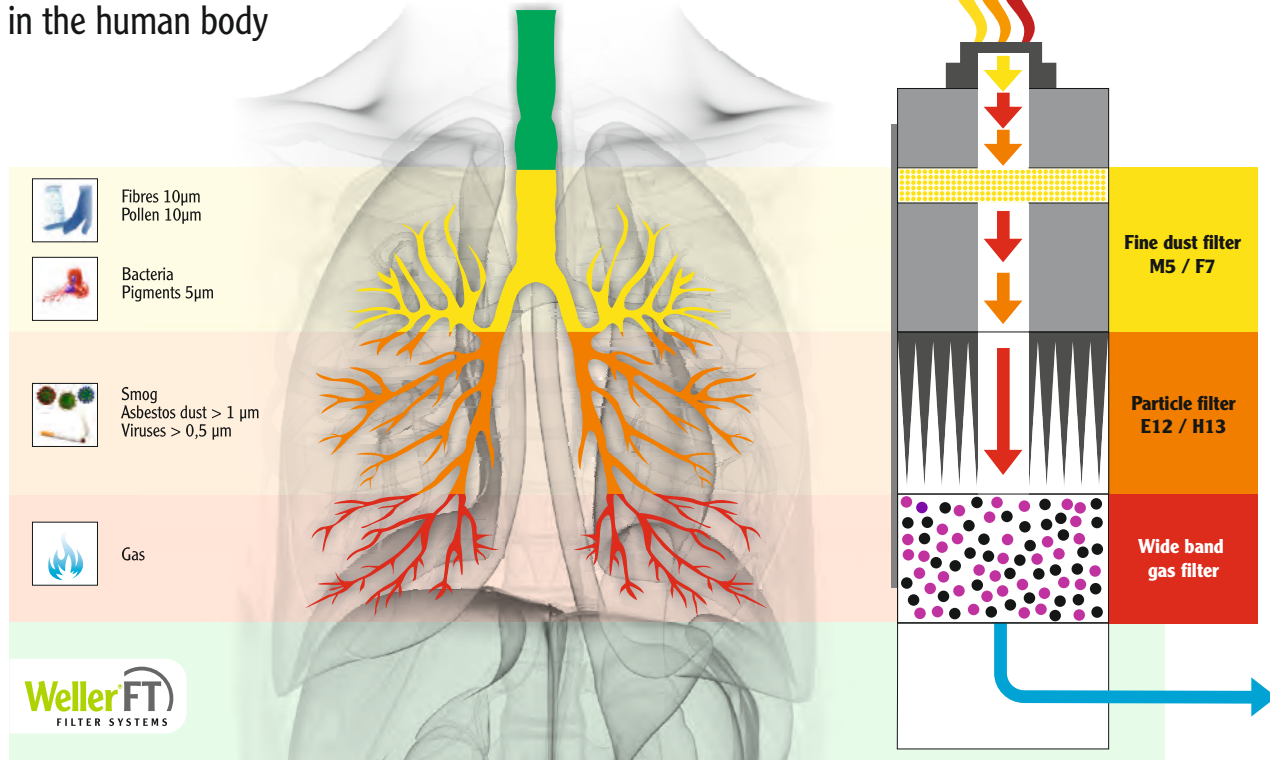

90 minutes soldering
with leadfree solder wire



Why fume extraction? See the movie on
www.youtube.com/wellersoldering



WellerFT offers two types of Fume Extraction solutions:

Volume Extraction



ESD safe

Set up your volume extraction solution with our configurator www.weller.eu



- > Large areas can be covered
- > Low maintenance
- > Mobile
- > Quick & easy installation
- > Economic for 1 to 8 work places
- > Extraction cabinets
- > Remote control



More suitable for applications involving, for example hand soldering, solder baths, hot air soldering, micro solders and gluing and cleaning work. WellerFT offers various mobile systems up to a maximum of 8 workplaces that purify the air.

For 1 extraction arm Ø 60

Volume flow rate = 50–80 m³/h
Underpressure = 300–700 Pa

For 6 extraction arms Ø 60

Volume flow rate = 300–480 m³/h
Underpressure = 300–700 Pa

Tip Extraction



ESD safe

- > Low investment per work place
- > Extract pollution direct at the source
- > Up to 20 soldering points with one system (max. 200 m apart)
- > Ergonomic with easy access to work piece
- > No noise
- > Minimal air movement



WellerFT FE (Fume extraction) soldering irons have a smoke tube integrated into the handle. When soldering the tube is positioned directly above the tip and collects any fumes produced. Fume extraction attachments can be retro fitted to non fume extraction Weller soldering irons.

For 1 FE soldering iron

Volume flow rate = 1–1,5 m³/h
Underpressure = 10.000 Pa

For 25 FE soldering irons

Volume flow rate = 25–30 m³/h
Underpressure = 10.000 Pa

Filter Technology

WellerFT Zero-Smog® Systems are specifically designed for continuous operation in industrial environments. Care and attention at the design stage plus careful component choice and a high quality manufacturing process have given Weller extraction systems a world wide reputation for reliability and longevity.

WellerFT Zero-Smog® Systems have a **three stage filter system (excl. MG 100S)** for removing small particles, fumes and gases that are produced in different working processes:

The hazardous substances are efficiently captured by the nozzle and are absorbed into the filter.

Bigger particles get caught in the pre-filter and smaller particles get caught in the HEPA (High Efficiency Particulate Air) filter.

The wide band gas filter removes fumes and adhesives.

End product – clean air – is re-circulated into the workplace.

Filter Class	Recommended Application
M5	For standard applications
F7	For applications with high flux or dust content
E12 / H13	For applications with high flux or dust content
Gas	For applications with extracting adhesive fumes and solvents applications

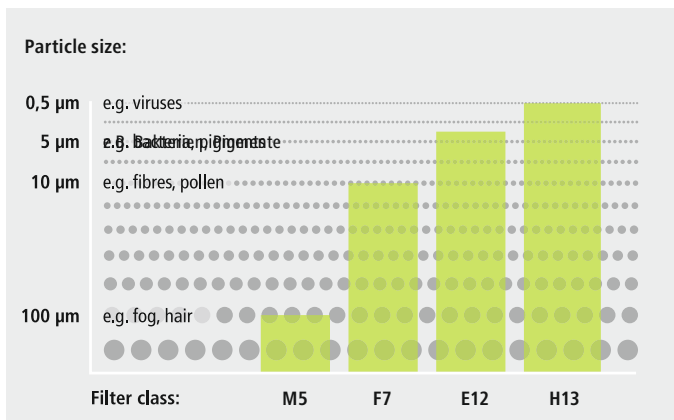

Filter Class M5, F7: Fine dust filter as per EN 779:2012
Filter Class E12/H13: According EN 1822:2009 HEPA (High Efficiency Particulate Air) Filter

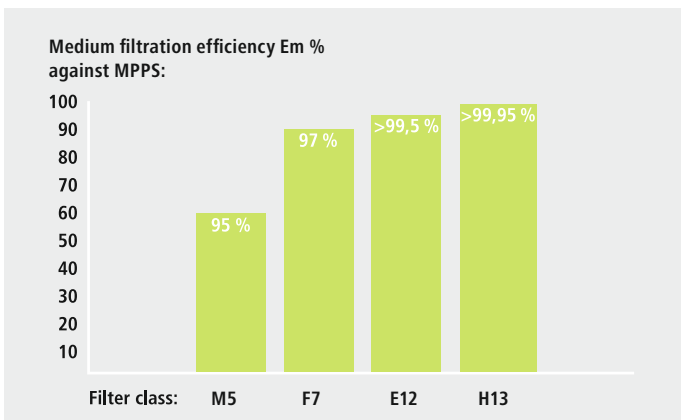

Special Filter



Cleanroom Filter
Filter for use in cleanroom



VOC Filter
Filter for solvents



MEK Filter
Filter for Methyl, Ethyl, Ketone



Adhesive Fume Filter
Filter for gluing and dry processes

Before using special filters MSD sheet must be checked. Please contact WellerFT for support.



1. Medium / fine dust filter

For standard applications with a small amount of flux and pollution gases with high solid content, WellerFT offers filter classes M5 or F7.



2. Compact filter consisting of:

Particle filter H13 with deposition performance according EN 1822:2009
 > 99,95 % in MPPS (particles 0,16 µm)
 > 99,994 % particles 0,3 µm

Wide band gas filter

For cleaning harmful fumes and vapours. The WellerFT wide band gas filter consists of **50 % active carbon and 50 % Chemisorb (potassium permanganate)**. Harmful gases with a high molecular weight are cleaned by the active carbon. Chemisorb is suitable for absorbing gases of lower molecular weight. Because of its composition, Chemisorb is able to convert a large number of chemical pollutants (e.g. formaldehyde) by means of molecular modification into non-polluting gases.



3. Gas filter (option)

The gas filter is used for extracting adhesive fumes and solvents. Experience has shown that filtering suspended particles is not so vital in this respect. The gas filter is filled with **50 % active carbon and 50 % Chemisorb**. The particle filter is omitted.

Filter classification according EN norm EN 1822:2009

Filter Class	Recommended Application
M5	For standard applications
F7	For applications with high flux or dust content
E12 / H13	For applications with high flux or dust content
Gas	For applications with extracting adhesive fumes and solvents applications

Group	Filter Class	Integral value	
		Degree of separation	Transmittance degree
EPA	E10	85 %	15 %
	E11	95 %	5 %
	E12	99,5 %	0,5 %
HEPA	H13	99,95 %	0,05 %
	H14	99,995 %	0,005 %

FT 12, WFE P

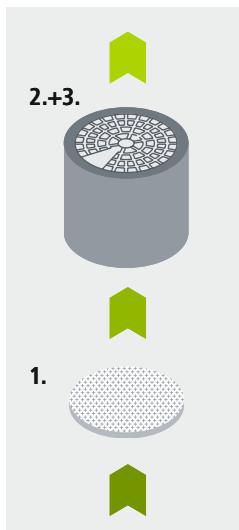

MG 100S

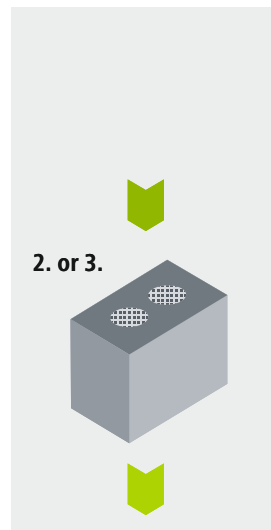

ZS 2, MG 130, MG 140, ZS 4V, ZS 6V, ZS 20T

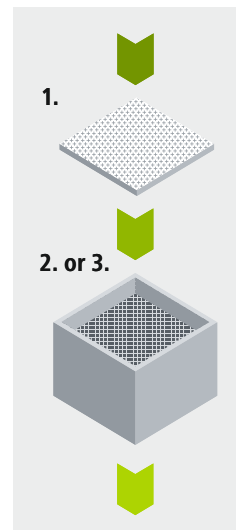

Filter drawings not true to original

Volume extraction

- › Volume extraction is the best choice where extraction over a wide area is required.
- › It is an economical way to eliminate polluted process air as there is no need for fixed installations and maintenance requirements are minimal.
- › Arms and nozzles do not require daily cleaning.
- › Energy costs are saved because the cleaned air is re-circulated back into the work area and does not need to be heated or cooled like external air.
- › Weller has a broad range of filter units for volume extraction applications
- › Speed control allows optimal air flow regulation for each working place independent of the connected workplaces (excl. ZS 2).
- › Units can be remotely controlled via a remote control system (available as accessory) or by a PC (RS232) connection (excl. ZS 2)
- › Easy-Click-System for fast and easy installation of workplaces



Characteristics

- > For applications where extraction over a wide working area is required
- > Mobile units suitable for stand alone and central applications
- > All units equipped with maintenance free brushless turbine
- > Connectable to external air outlet (only ZS 4V/6V)
- > Vacuum up to 4.200 Pa and high volume for efficient volume extraction
- > Maximum bridging distance 30 m (Zero Smog 6V using Weller pipe system 70) equally distributed to all connected extraction device
- > Cost saving through automatic air flow control which provides each workplace with intelligent air flow regulation regardless of the connected workplaces (excl. ZS 4V/6V)
- > Filter condition monitoring on the unit or by remote control (accessory)

Areas of application

- > Hand soldering processes
- > Soldering machines, robots, solder baths
- > Adhesive fumes
- > Clean room applications (on request)
- > Microscope workplaces
- > Other fume emitting processes



Zero Smog 2



MG 140



MG 130



Zero Smog 4V



MG 100S



Zero Smog 6V

Volume Extraction / Technical Data

Standard systems



1–2 workplaces



1–2 workplaces



up to 2 workplaces

	Zero Smog 2	MG 130	MG 100S
Dimensions L x B x H (mm / in)	360 x 330 x 415 mm 14,17 x 12,99 x 16,33 in	460 x 210 x 500 mm 18,11 x 8,26 x 19,68 in	460 x 210 x 610 mm 18,11 x 8,26 x 24,15 in
Weight (kg / lb)	9 kg / 19.8 lb	11 kg / 24.3 lb	15 kg / 33.1 lb
Voltage	230 V, 50 Hz (120 V, 60 Hz)	100–240 V, 50/60 Hz	100–240 V, 50/60 Hz
Noise level at 1 m *	50 dB (A)	< 52 dB (A)	< 52 dB (A)
Electrical power	200 W	100 W	100 W
Max. blower vacuum	3.000 Pa	2.300 Pa	2.300 Pa
Max. blower capacity	190 m ³ /h	140 m ³ /h	140 m ³ /h
Pre-filter	Medium dust filter M5	Fine dust filter F7	–
Compact filter	Particle filter E12 + gas filter (active carbon foam) low	Particle filter H13 + gas filter (50 % active carbon + 50 % Chemisorb)	Particle filter H13 + gas filter (50 % active carbon + 50 % Chemisorb)
Gas filter volume	low	low	high
Particle filter separation degree MPPS	> 99,5 %	> 99,95 %	> 99,95 %

* At typical operating speed

Selection guide based on particle- and gas filter capacity

Application	Zero Smog 2	MG 130	MG 100S
Hand soldering	++	++	+++
Heavy duty soldering (solder bath, selective wave)	+	+	+
Soldering, Gluing, Cleaning, Filling	+	++	+++
Gluing, Cleaning, Filling	+	++	+++
Finedust	++	++	+
MEK (Methyl Ethyl Keton)		+	+++
VOC (Volatile Organic Compounds)		+	+++
Cleanroom			+++

+ short term use ++ medium term use +++ long term use

Central system with
automatic flow control



up to 2 workplaces



up to 4 workplaces



up to 8 workplaces

	MG 140	Zero Smog 4V	Zero Smog 6V
Dimensions L x B x H (mm / in)	350 x 335 x 655 mm 13,77 x 13,18 x 25,78 in	345 x 325 x 505 mm 13,58 x 12,79 x 19,88 in	460 x 460 x 665 mm 18,11 x 18,11 x 26,18 in
Weight (kg / lb)	18 kg / 39.7 lb	19 kg / 41.9 lb	40 kg / 88.2 lb
Voltage	100 – 240 V, 50/60 Hz	230 V / 50 Hz (120 V / 60 Hz)	230 V / 50 Hz (120 V / 60 Hz)
Noise level at 1 m *	< 50 dB (A)	48 dB (A)	51 dB (A)
Electrical power	100 W	275 W	460 W
Max. blower vacuum	2.300 Pa	2.700 Pa	3.000 Pa
Max. blower capacity	140 m ³ /h	230 m ³ /h	645 m ³ /h
Pre-filter	Fine dust filter F7	Fine dust filter F7	Fine dust filter F7
Compact filter	Particle filter H13 + gas filter (50 % active carbon + 50 % Chemisorb)	Particle filter H13 + gas filter (50 % active carbon + 50 % Chemisorb)	Particle filter H13 + gas filter (50 % active carbon + 50 % Chemisorb)
Gas filter volume	high	medium	high
Particle filter separation degree MPPS	> 99,95 %	> 99,95 %	> 99,95 %

* At typical operating speed

Application	MG 140	Zero Smog 4V	Zero Smog 6V
Hand soldering	+++	+++	+++
Heavy duty soldering (solder bath, selective wave)	++	++	+++
Soldering, Gluing, Cleaning, Filling	+++	++	+++
Gluing, Cleaning, Filling	+++	+++	+++
Finedust	+++	++	+++
MEK (Methyl Ethyl Keton)	+++	+	+
VOC (Volatile Organic Compounds)	+++	+	+++
Cleanroom	+++		+++

+ short term use ++ medium term use +++ long term use

Zero Smog 2

Applications:

- > Hand soldering
- > Heavy duty and general soldering
- > Fine dust



The fume extraction unit Zero Smog 2 is easy to install and operate. It is designed as a small, economical central system for two workplaces. The Zero Smog 2 is available in a beneficial kit.

Technical Data	
Max. capacity	1–2 work places
Max. blower extraction rate	190 m³/h
Noise level	50 db (A) at 1 m distance
Voltage	230 V, 50 Hz (120 V, 60 Hz)
Electrical power	200 W
Max. blower vacuum	3.000 Pa
Dimensions (L x W x H)	360 x 330 x 415 mm
Weight	9 kg



Scope of supply

- > Zero Smog 2 Fume extraction unit 240 V / 50/60 Hz
- > Particle filter E12 and active carbon
- > Medium dust pre-filter M5

Order No. 230 V FT91004699

Order No. 120 V (USA) Zero Smog 2

Option:

- > Zero Smog 2 Fume extraction unit
- > Adhesive fume filter (50 % active carbon + 50 % Chemisorb)
- > Medium dust pre-filter F7

Order No. 230 V FT91005699



Attributes

- > Economical unit purifies air up to 2 workplaces
- > Easy filter exchange
- > Quick and simple installation
- > Portable fume extraction unit

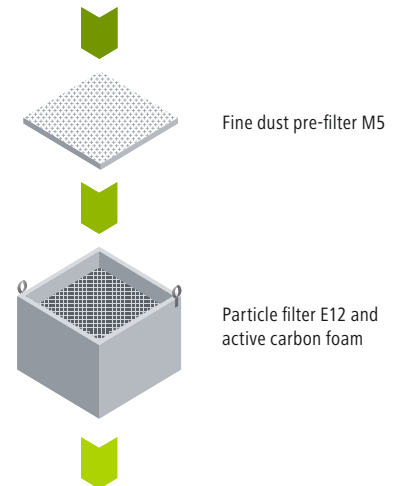

Zero Smog 2 Kit



Scope of supply

- Zero Smog 2 Kit consists of:
- > Zero Smog 2
 - > Kit 1 WF Funnel (see page 23)

Order No. 230 V FT91006699

Order No. 120 V (USA) Zero Smog 2 KIT 1

MG 130

Applications:

- > Hand soldering
- > Heavy duty and general soldering
- > Gluing, cleaning, filling
- > Fine dust
- > MEK
- > VOC



The fume extraction unit MG 130 Kit is easy to install and operate. Is supplied complete with flexible arms, ready to place close to the workbench.



Attributes

- > Unit purifies air up to 2 workplaces
- > Filter alarm and 3 steps speed control
- > Small design
- > 100–240 power supply

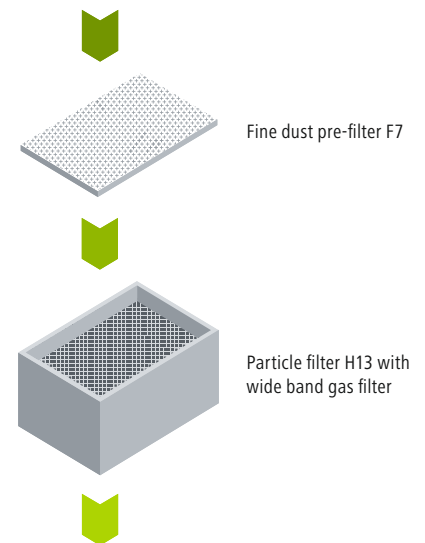

Technical Data	
Max. capacity	1–2 work places
Max. blower extraction rate	140 m ³ /h
Noise level	< 52 dB (A) at 1 m distance
Voltage	100–240 V, 50/60 Hz
Electrical power	100 W
Max. blower vacuum	2.300 Pa
Dimensions (L x W x H)	460 x 210 x 500 mm
Weight	11 kg

Scope of supply	
MG 130 Fume extraction unit 100–240 V / 50/60 Hz	
> Compact filter	
consists of: Particle filter H13 and Wide band gas filter (50 % active carbon + 50 % Chemisorb)	
> Pre-filter F7	
Order No. 100–240 V	130-1000-ESD

MG 130 Kit Nozzle	
consists of:	
> MG 130 fume extraction unit	
> 0F10 Extraction arm, 2 x	
> FT-NL Nozzle, 2 x	
Order No.	130-1055-ESD

MG 130 Kit Funnel	
Same as 130-1055-ESD but with ALFA nozzle	
Order No.	FT91000103



ESD safe



low sound level

MG 100S

Applications:

- > Hand soldering
- > Gluing, cleaning, filling
- > Fine dust
- > MEK
- > VOC



Attributes

- > Unit purifies air at up to 2 workplaces
- > High Gasfilter volume
- > Electronic filter control with filter alarm
- > Variable speed setting
- > Minimized foot print
- > Switching power supply 100 – 240 V
- > Optimized filter lifetime



MEK



SOLVENTS/VOC



CLEANROOM

Can be equipped with a special filter suitable for different applications.

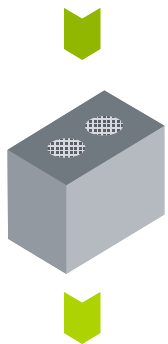

Particle filter H13 and wide band gas filter

The MG 100S fume extraction unit is suitable for applications with a high demand of gases.

Variable speed and alarm function for filter exchange can be set via the remote control. To make installation easier, the MG 100S can be suspended at the work table with special table mounting set (780-3001-ESD).



ESD safe



low sound level

Technical Data

Max. capacity	1–2 work places
Max. blower extraction rate	140 m ³ /h
Noise level	< 52 db (A) at 1 m distance
Voltage	100–240 V / 50/60 Hz
Electrical power	100 W
Max. blower vacuum	2.300 Pa
Dimensions (L x W x H)	460 x 210 x 610 mm
Weight	15 kg

Scope of supply

- > MG 100S Fume extraction unit 100–240 V / 50/60 Hz
- > Compact filter consists of: Particle filter H13 and Wide band gas filter (50 % active carbon / 50 % Chemisorb)

	Order No.
MG 100S Filter System 230 V	100-1000-ESD
MG 100S Filter System 120 V (USA)	U-100-1000-ESD

Accessories:

Remote control with 1 m cable	Order No. 700-3057
-------------------------------	--------------------

MG 100S Kit 1 / Kit 2



Scope of supply

MG 100S Kit 1 consists of:

- > MG 100S extraction unit
- > Kit 1 WF Funnel (see page 23)

Order No. 230 V	100-1056-ESD
Order No. 120 V (USA)	U-100-1056-ESD

MG 100S Kit 2 consists of:

- > MG 100S extraction unit
- > 2 x 0F15 Flexible arm length 1,5 m
- > 2 x ALFA Funnel nozzle

Order No. 230 V	100-1055-ESD
Order No. 120 V (USA)	U-100-1055-ESD

MG 140

Applications:

- > Hand soldering
- > Heavy duty and general soldering
- > Gluing, cleaning, filling
- > Fine dust
- > MEK
- > VOC
- > Clean room



Attributes

- > Unit purifies air at up to 2 workplaces
- > High gasfilter volume
- > Electronic filter control with alarm function
- > Variable speed setting
- > 3 Step Filter System
- > Quick and simple installation
- > 4 Wheels for easy movement
- > Switch power supply 100 – 240V



MEK



SOLVENTS/VOC



CLEANROOM

Can be equipped with a special filter suitable for different applications.

The MG 140 is suitable of applications with a high demand of gas and particle filtration, e.g. soldering, adhesives, clean room work.

It can be placed and be moved easily between different work places. Variable speed and alarm function for filter exchange can be set via the remote control.



ESD safe



low sound level

Technical Data

Max. capacity	2 work places
Max. blower extraction rate	140 m ³ /h
Noise level	< 50 db (A) at 1 m distance
Voltage	100–240 V / 50/60 Hz
Electrical power	100 W
Max. blower vacuum	2.300 Pa
Dimensions (L x W x H)	350 x 335 x 655 mm
Weight	18 kg

Scope of supply

- > MG 140 Fume extraction unit 100–240 V / 50/60 Hz
- > Compact filter consists of: Particle filter H13, Wide band gas filter (50 % active carbon / 50 % Chemisorb)
- > Pre-filter F7

	Order No.
MG 140 Filter unit 230 V	145-1000-ESD
MG 140 Filter unit 230 V with cleanroom filter	145-1002-ESD
MG 140 Filter unit 120 V (USA)	U-145-1000-ESD
MG 140 Filter unit 120 V with cleanroom filter (USA)	U-145-1002-ESD

Accessories:

Remote control with cable	Order No. 700-3057
---------------------------	--------------------

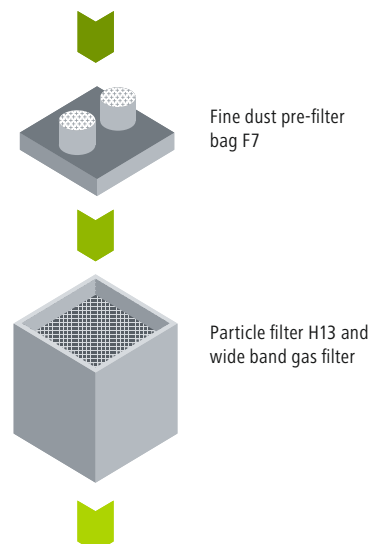

Zero Smog 4V

Applications:

- > Hand soldering
- > Heavy duty and general soldering
- > Gluing, cleaning, filling
- > Fine dust
- > MEK
- > VOC

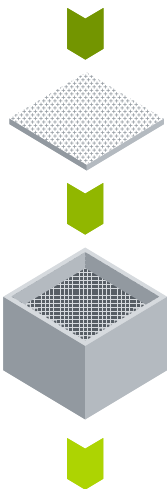

Fine dust pre-filter F7

Particle filter H13 and wide band gas filter



ESD safe



low sound level

Technical Data

Max. capacity	4 work places
Max. blower extraction rate	230 m ³ /h
Noise level	48 db (A) at 1 m distance
Standard Connection	Easy-Click 60
Voltage	230 V / 50 Hz (120 V / 60 Hz)
Electrical power	275 W
Max. blower vacuum	2.700 Pa
Dimensions (L x W x H)	345 x 325 x 505 mm
Weight	19 kg

The fume extraction unit Zero Smog 4V (ZS 4V) is easy to install and operate. It is designed for use as a small central system. The kits supplied complete with flexible hose, arm and bracket, ready for installation at the workplace. A powerful, maintenance-free turbine provides continuous fume extraction at a maximum air extraction rate of 230 m³/h. With setting constant flow control the adjustable turbine speed avoiding unnecessary waste of suction power and saving energy.

Scope of supply Zero Smog 4V

- > ZS 4V Fume extraction unit
- > Compact filter consists of: Particle filter H13 and wide band gas filter (50 % active carbon / 50 % Chemisorb)
- > Fine dust Pre-filter F7

Order No. 230 V T005 36 606 99

Order No. 100–120 V (USA) T005 36 602 99

Option Zero Smog 4V with gas filter

Wide band gas filter (50 % active carbon / 50 % Chemisorb)

Order No. 230 V T005 36 616 99

Order No. 100–120 V (USA) T005 36 612 99



Attributes

- > Unit purifies air at up to 4 workplaces
- > Constant Flow Control (CFC) guarantees automatic air flow regulation for each working place independent of the connected workplaces
- > Electronic filter control with optical and acoustical filter alarm
- > Efficiency test via USB port
- > 4 wheels to allow easy movement of the unit
- > Remote control via RS 232 port
- > Low noise level
- > 4 kits available

Zero Smog 4V kits with nozzle or funnel



Scope of supply

Kit 1 Nozzle consists of:

- > ZS 4V Fume extraction unit
- > KIT 1 Nozzle (see page 23)

Order No. 230 V T005 36 636 99

Order No. 100–120 V (USA) T005 36 632 99

Kit 2 Nozzle consists of:

- > ZS 4V Fume extraction unit
- > 2 x KIT 1 Nozzle (see page 23)

Order No. 230 V T005 36 656 99

Order No. 100–120 V (USA) T005 36 652 99

Kit 1 Funnel consists of:

- > ZS 4V Fume extraction unit
- > KIT 1 Funnel (see page 23)

Order No. 230 V T005 36 626 99

Order No. 100–120 V (USA) T005 36 622 99

Kit 2 Funnel consists of:

- > ZS 4V Fume extraction unit
- > 2 x KIT 1 Funnel (see page 23)

Order No. 230 V T005 36 646 99

Order No. 100–120 V (USA) T005 36 642 99

Zero Smog 6V

Applications:

- > Hand soldering
- > Heavy duty and general soldering
- > Gluing, cleaning, filling
- > Fine dust
- > MEK
- > VOC
- > Clean room

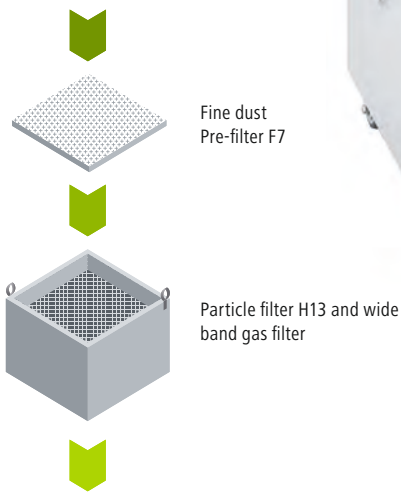

Attributes

- > Unit purifies air at up to 8 workplaces
- > The Constant Flow Control (CFC) guarantees optimal air flow regulation for each working place independent of the connected workplaces
- > Efficiency test via USB port
- > Electronic filter control with optical and acoustical filter alarm
- > 4 wheels to allow easy movement of the unit
- > Remote control via RS 232 port
- > Low noise level

The powerful maintenance free variable speed turbine is electronically controlled and has a maximum blower capacity of 645 m³/h. It has 3 operating modes:

1. Standard speed control – selected by the user irrespective of the load on the system.
2. Speed limiting control – the turbine speed is automatically varied to match the load on the system.
3. Economy control – the rate of fume absorption is maintained at a constant value. The operating hours and the filter condition are recorded for maintenance purposes.

Pre-filter to extend capacity of Zero Smog 6V and WFE 4S



The Pre-filter is recommended for use with solder bath, automatic soldering or other major dust emitting applications. It acts as a first stage in the filter process increasing the lifetime of the main filter units. The Pre-filter can be fixed directly to the top of the ZS 6V or in conjunction with all WellerFT volume extraction units as an external part of the fume extraction system.

Scope of supply

- > Filter box
 - > 1 x Easy Click 60 connector
- Filters must be ordered separately (see page 48)

Order No. T005 87 358 62

The fume extraction system Zero Smog 6V (ZS 6V) is user-friendly with quick and simple installation and filter exchange. It has a low noise emission level and is small and convenient to locate within the work area.

The high quality components used in the ZS 6V result in low servicing requirements and long system life. To increase filter lifetime and save on energy, the ZS 6V is fitted with an constant flow control (CFC) – depending on the number of connected workplaces. To extend the capacity an external pre-filter can be fixed directly to the ZS 6V.



ESD safe



low sound level

Technical Data

Max. capacity	8 work places
Max. blower extraction rate	645 m ³ /h
Noise level	51 db (A) at 1 m distance
Standard Connection	Easy-Click 60
Voltage	230 / 50 Hz (120 V / 60 Hz)
Electrical power	460 W
Max. blower vacuum	3.000 Pa
Dimensions (L x W x H)	460 x 460 x 665 mm
Weight	40 kg

Scope of supply

- > ZS 6V Fume extraction unit
- > Compact filter consists of: Particle filter H13 and wide band gas filter (50 % active carbon / 50 % Chemisorb)
- > Fine dust Pre-filter F7

Order No. 230 V T005 36 666 99

Order No. 100–120 V (USA) T005 36 662 99

Option ZS 6V with gas filter

- > Compact filter for adhesive fumes. Consists of: Wide band gas filter (50 % active carbon / 50 % Chemisorb)
- > Fine dust filter F7

Order No. 230 V T005 36 676 99

Order No. 100–120 V (USA) T005 36 672 99

Installation Options with Easy-Click-System

Installation option for a central system on a soldering work bench with Zero-Smog 4V

Total pipe length max. 15 m (590.55 in)

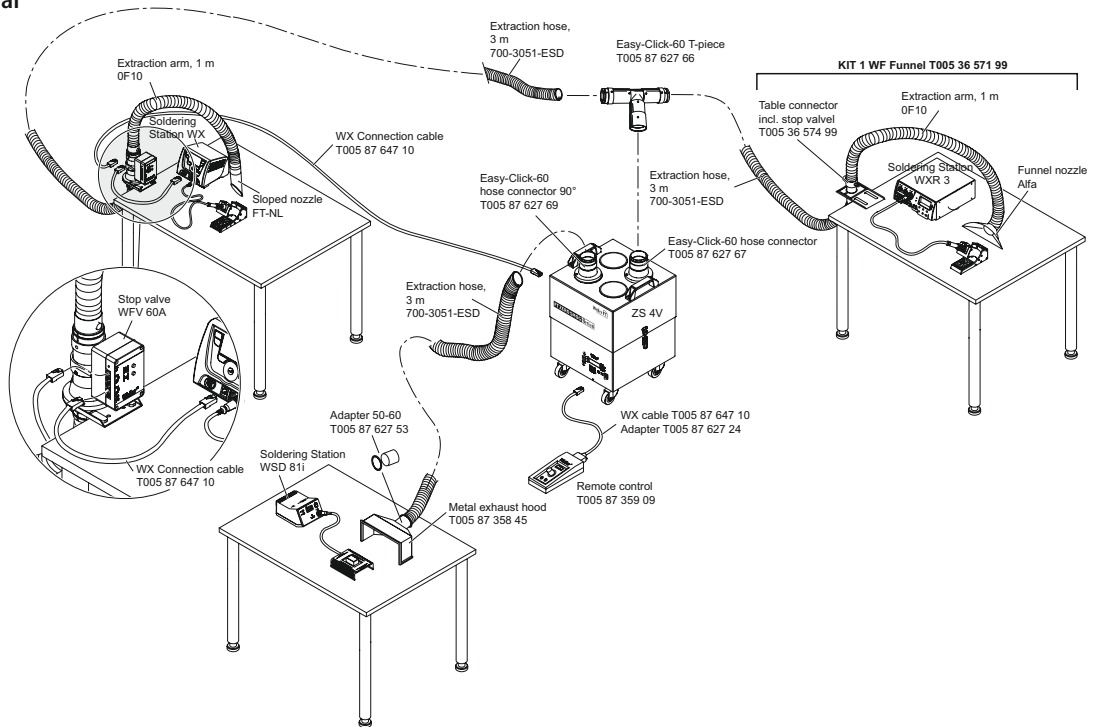

Installation option for a central and stand alone system on a soldering work bench with Zero-Smog 6V

Total pipe length max. 30 m (1181.10 in)

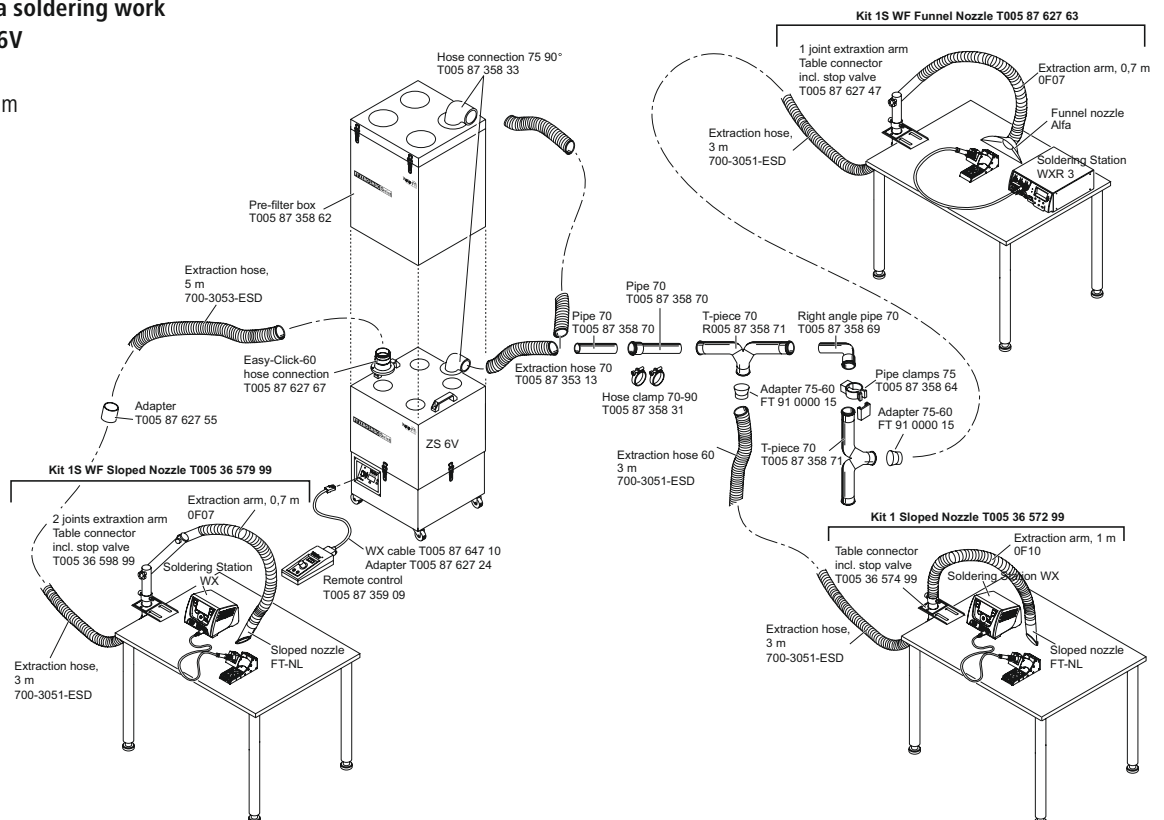

Applications:

- > Soldering
- > Gluing, cleaning, filling
- > Laboratories



The air curtain cabinet CBC-A has a unique ventilation concept that separates the operator from the process by a dual air curtain system, giving unlimited accessibility on the workbench. It stands directly on the workbench and is easily connected to WellerFT mobile filter system or to central ventilation.

Technical Data

Height, int. / ext.	525 / 625 mm
Width, int. / ext.	1.120 / 1.275 mm
Depth, int. / ext.	580 / 760 mm
Weight	53 kg
Sound level	< 49 dB (A) at 1 m

For CBC-A 112 G04 2 pieces MG 100S or 1 ZS 6V extraction units with high gas filter volume are needed. Minimum extraction volume 180 m³/h maximum 230 m³/h.



ESD safe



Blue = Clean air
Yellow = Polluted air

Order No.	Description
CBCA112G02G65I2	Model CBC-A-112 , cabinet supplied with a sheet top cover with one Ø 160 mm connection, sheet back panel and tube lighting (2 x 39 W), 230 V
CBCA112G02G65I2115	Model CBC-A-112 , 120 V version
CBCA112G04G65I2	Model CBC-A-112 , cabinet supplied with a sheet top cover with 4 Easy-Click 60 connections to fit 2 x MG 100S, sheet back panel and tube lighting (2 x 39 W), 230 V.
CBCA112G04G65I2115	Model CBC-A-112 , 120 V version

Accessories and spare parts

Order No.	Description
G02	Topcover in sheet for CBC, 1160 x 580 x 1,25 mm with one Ø 160 mm connection, ESD-safe
G04	Topcover for CBC, same as G02 but with 4 Easy-Click 60 connections, ESD-safe
I2	Lighting appliance with fluorescent tube lighting (2 x 39 W), 230 V
F02	Tube lighting 39 W , (4 pcs) suitable for CBC-A with lighting I2
300-6001	Power supply CBC-A

Acryl Exhaust Cabinets

The ESD safe **WESDA Acryl exhaust cabinets** are designed to store components during the drying time after gluing or epoxy resin filling processes. The gas emissions are extracted by an extraction unit connected via an easy click 60 hose adapter at the back of the cabinet.



WESDA 402

Acryl Extraction cabinet 400 Ltr.



WESDA 402 Acryl Extraction cabinet 400 Ltr.

Order No. FT91000021

Needed Accessories:

Order No.

Easy Click extraction hose (see page 29)

Extraction unit Zero-Smog 4V with adhesive fume filter part T005 36 616 99

Technical Data

Housing	ESD-Polycarbonat
Dimensions (L x W x H)	517 x 574 x 1960 mm 20,3 x 22,5 x 77,16 in
Volume	400 Ltr.
Weight	59 kg / 130 lb
No. lower shelf	4

WESDA 201

Acryl Extraction cabinet 200 Ltr.



WESDA 201 Acryl Extraction cabinet 200 Ltr.

Order No. FT91000020

Needed Accessories:

Order No.

Easy-Click extraction hose (see page 29)

Extraction unit Zero-Smog 4V with adhesive fume filter part T005 36 616 99

Technical Data

Housing	ESD-Polycarbonat
Dimensions (L x W x H)	517 x 574 x 750 mm 20,3 x 22,5 x 29,5 in
Volume	200 Ltr.
Weight	30 kg / 66 lb
No. lower shelf	2

Extraction Hood Top

WEHT Extraction Hood Top for applications where fumes spread rapidly due to a drafty work environment. The hood can enclose the source, enabling fumes to be captured before they contaminate the workplace.



Technical Data	
Housing	PET not ESD safe
Dimensions (L x W x H)	860 x 510 x 460 mm 33,8 x 20,0 x 18,1 in

Zero Smog 4 V Kit Extraction Hood Top

Scope of supply

- > 700-3051-ESD WEHT Extraction hood top
- > 700-3051-ESD Extraction Hose Easy-Click 60, 3 m
- > T005 36 606 99 Zero-Smog 4 V Extraction unit (see page 16)

Order No. **FT91000024**

Extraction Hood Bottom

WEHB Extraction Hood Bottom for gluing or cleaning applications where gases from solvents or glue, lighter than air have to be extracted from below. The work place is covered with a punched stainless steel plate.



Technical Data	
Housing	PET not ESD safe
Dimensions (L x W x H)	860 x 510 x 460 mm 33,8 x 20,0 x 18,1 in

Zero Smog 4 V Kit Extraction Hood Bottom

Scope of supply

- > 700-3051-ESD WEHB Extraction hood bottom
- > 700-3051-ESD Extraction Hose Easy-Click 60, 3 m
- > T005 36 616 99 Zero-Smog 4 V Extraction unit with adhesive fume filter (see page 16)

Order No. **FT91000025**

To guarantee sufficient extraction results an extraction unit with minimum 230 m³/h must be connected to the hoods (WellerFT Zero Smog 4V).

Fume Extraction / Pressure Drop

Extraction Arms from WellerFT feature very slow pressure drop and are excellent for connecting to central ventilation systems.

The diagram below shows the pressure drop in some of the standard arms.



Kit 1 WF Funnel / Sloped



700-3051-ESD



Kit 1S WF Funnel
(1 Joint)



Kit 1 WF 32



Kit 1S WF Sloped Nozzle
(2 Joints)

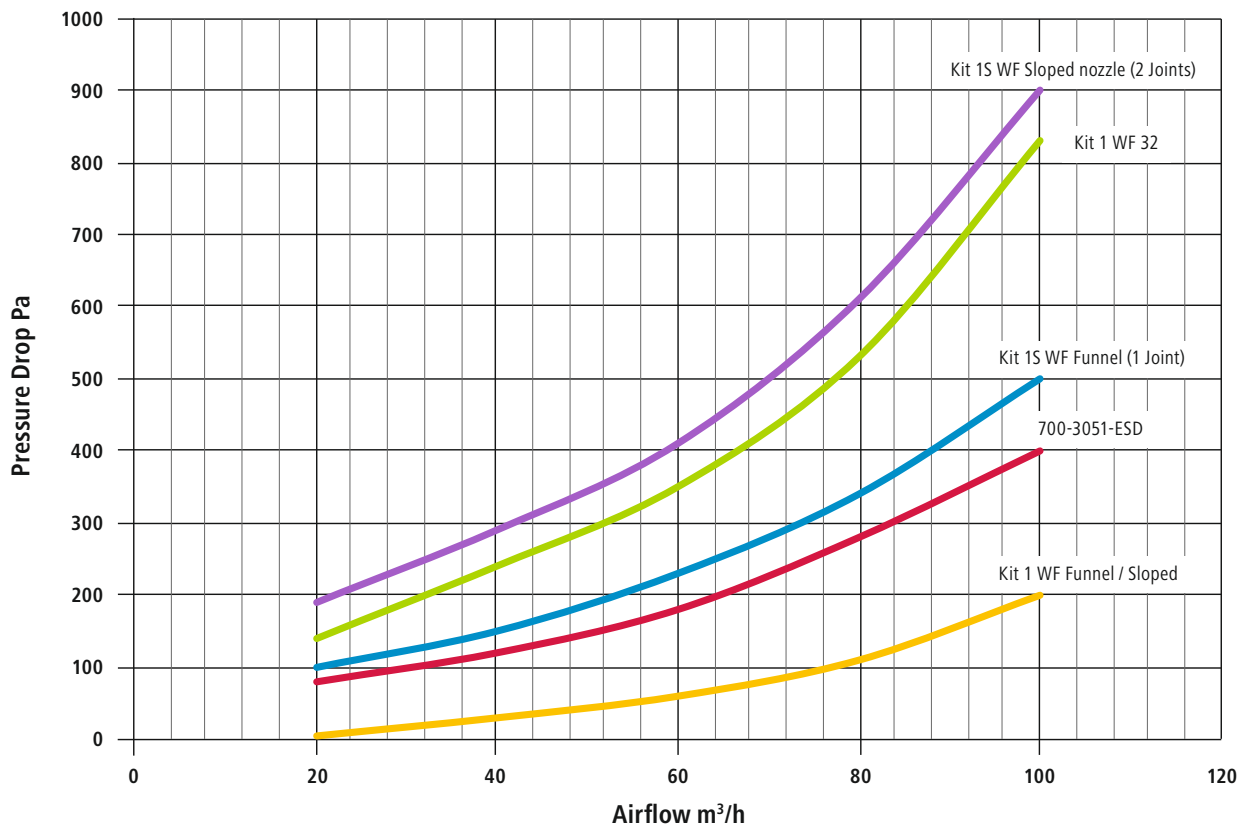

> Extraction arm for application with less space



Kit 1 WF 32



Order No.	Description
T005 87 627 70	Easy-Click 60 extraction arm with sloped nozzle Ø 60 mm, length 1 m, Ø 32 mm, stop valve
Consists of:	
T005 36 574 99	Stop valve with bench mounting brackets
700-3051-ESD	Extraction hose, flexible, 3 m, Ø 60 mm
T005 36 580 99	Extraction arm Ø 32 mm, 1 m
T005 87 628 34	Sloped Nozzle

> Extraction arm with funnel nozzle



Kit 1 WF Funnel



Order No.	Description
T005 36 571 99	Easy-Click 60 extraction arm with funnel, width 230 mm, height 100 mm, flexible arm, Ø 60 mm, length 1 m, with stop valve
Consists of:	
T005 36 574 99	Stop valve with bench mounting brackets
700-3051-ESD	Extraction hose, flexible, 3 m, Ø 60 mm
0F10	Extraction arm Ø 60 mm, 1 m
ALFA	Funnel nozzle

> Extraction arm with sloped nozzle



Kit 1 Sloped Nozzle



Order No.	Description
T005 36 572 99	Easy-Click 60 extraction arm with sloped nozzle, Ø 60 mm, length 1 m, stop valve
Consists of:	
T005 36 574 99	Stop valve with bench mounting brackets
700-3051-ESD	Extraction hose, flexible, 3 m, Ø 60 mm
0F10	Extraction arm Ø 60 mm, 1 m
FT-NL	Sloped nozzle

Easy-Click 60 Extraction Arms

> 2 joint arm and sloped nozzle



> 1 joint arm and funnel nozzle



Kit 1S Sloped Nozzle



Order No.	Description
T005 36 579 99	Easy-Click 60 2 joint aluminium extraction arm with sloped nozzle, stop valve, length 1,5 m
Consists of:	
T005 36 598 99	2 joint arms with stop valve and bench mounting brackets
700-3051-ESD	Extraction hose, flexible, 3 m, Ø 60 mm
OFO7	Flex. extraction arm Ø 60 mm, 0,7 m
FT-NL	Sloped nozzle

Kit 1S Funnel Nozzle



Order No.	Description
T005 87 627 63	Easy-Click 60 1 joint aluminium extraction arm with funnel nozzle, stop valve, length 1,14 m
Consists of:	
T005 87 627 47	1 joint arm with stop valve and bench mounting brackets
700-3051-ESD	Extraction hose, flexible, 3 m, Ø 60 mm
OFO7	Flex. extraction arm Ø 60 mm, 0,7 m
ALFA	Funnel nozzle

Extraction Tripod



Order No.	Description
FT91000026	Easy-Click 60 1 joint extraction tripod for volume extraction in higher work area like soldering in switch cabinets. Ready for mounting on Zero Smog 4 V and WFE 2S. Measurements with extraction unit: High 1300 mm, Joint 213 mm

> **1 Joint Arm**



1 Joint Extraction Arm



Order No.	Description
T005 87 627 47	Easy-Click 60 1 joint aluminium extraction arm with valve and bench mounting brackets

> **2 Joint Arm**



2 Joint Extraction Arm



Order No.	Description
T005 36 598 99	Easy-Click 60 2 joint aluminium extraction arm with valve and bench mounting brackets

> **Ball Joint Arm**



Ball Joint Extraction Arm



Order No.	Description
FT-3446	Easy-Click 60 ball joint aluminium extraction arm with valve and ball joint bracket

> **1 Joint Double Arm**



1 Joint Double Arm



Order No.	Description
FT-4402	Easy-Click 60 1 joint double aluminium extraction arm with valve and bench mounting brackets

Easy-Click 60 Extraction Arms

> 1 Joint Extension



Extension Rotating Joint



Order No.	Description
FT-3417	Easy-Click 60 extension joint rotating for all Easy-click aluminium extraction arms

> 1 Joint Extension



Extension Rotating Joint with P nozzle



Order No.	Description
FT-3475	Easy-Click 60 extension rotating joint with length adjustable sloped 45° P nozzle for all Easy-click aluminium extraction arms

> Wall Mounting Arm



1 Joint Wall Mounting Arm



Order No.	Description
FT-3470	Easy-Click 60 1 joint aluminium extraction arm for wall mounting with valve



WF 32 Extraction Arm, Ø 32 mm, with nozzle



Order No.	Description
T005 36 580 99	ESD microscope extraction arm , flexible, Ø 32 mm, aluminium nozzle sloped 45°, length 1 m



Flexible Extraction Arm, Ø 32 mm



Order No.	Description
3-0F05	Flexible, adjustable arm, Ø 32 mm, length 0,5 m
3-0F07	Flexible, adjustable arm, Ø 32 mm, length 0,7 m
3-0F15	Flexible, adjustable arm, Ø 32 mm, length 1,5 m



Flexible Extraction Arm, Ø 60 mm



Order No.	Description
0F05	Flexible, adjustable arm, length 0,5 m incl. connection (female) in both ends
0F07	Flexible, adjustable arm, length 0,7 m incl. connection (female) in both ends
0F10	Flexible, adjustable arm, length 1,0 m incl. connection (female) in both ends
0F15	Flexible, adjustable arm, length 1,5 m incl. connection (female) in both ends
0F20	Flexible, adjustable arm, length 2,0 m incl. connection (female) in both ends

Extraction Arm Nozzles



Order No.	Description
ALFA	Easy-Click 60 funnel nozzle* 225 mm x 100 mm
ALFA-T	Easy-Click 60 transparent funnel nozzle* 225 mm x 100 mm











Not ESD safe

* to be mounted on an aluminium extraction arm without flexible hose, adapter Z is needed. See extractions arms accessories.

Extraction Arm Accessories



Order No.	Description	
FT-N	Easy-Click 60 metal sloped nozzle* Ø 50 mm, length 130 mm	 ESD safe
FT-NL	Easy-Click 60 metal sloped nozzle* Ø 60 mm, length 130 mm	 ESD safe
FT-NS	Easy-Click 60 metal tube nozzle, sloped with grid* Ø 50 mm, length 130 mm	 ESD safe
FT-P	P nozzle, metal tube nozzle sloped for aluminium arms, Ø 50 mm, length adjustable (105–235 mm)	 ESD safe
T005 87 628 34	Metal sloped nozzle 32 for 32 mm flex arms, Ø 31 mm, length 100 mm	 ESD safe
FT-U	Easy-Click 60 nozzle* width 190 mm, length 100 mm	 ESD safe
T005 87 358 45	Metal exhaust hood 200 x 100 mm (7.87 x 3.93 in), recommended for use with hot air soldering operations incl. adapter T005 87 627 53	 ESD safe
Z	Adapter to mount nozzles on aluminium arm with possibility to turn the nozzle (360°)	 ESD safe

* to be mounted on an aluminium extraction arm without flexible hose, adapter Z is needed.
See extraction arms accessories.

Accessories



Order No.	Description
700-3026	Cleaning Brush with Ø 60 mm flexible arms



ESD safe



T005 87 627 67	Easy-Click 60 hose connector male, straight for ZS 4V, ZS 6V, WFE 2S, WFE 4S and pre-filter box
----------------	---



ESD safe



T005 87 627 69	Easy-Click 60 hose connector male, angle 90° for ZS 4V, ZS 6V, WFE 2S, WFE 4S and pre-filter box
----------------	--

Extraction hose



ESD safe



Order No.	Description
700-3040-ESD	Easy-Click 60 extraction hose, Ø 60 mm incl. quick connections, length 1 m
700-3041-ESD	Easy-Click 60 extraction hose, Ø 60 mm incl. quick connections, length 2 m
700-3051-ESD	Easy-Click 60 extraction hose, Ø 60 mm incl. quick connections, length 3 m
700-3053-ESD	Easy-Click 60 extraction hose, Ø 60 mm incl. quick connections, length 5 m

Accessories

Easy-Click 60



Order No.	Description
T005 87 627 55	Easy-Click 60 male adapter for hose extension, Ø 60 mm
T005 87 627 72	Easy-Click 60 female adapter
T005 87 627 73	Easy-Click 60 male adapter 90°
T005 87 620 36	Extraction hose 60 m heavy construction, sold by meter (max. length 15 m)
T005 87 627 68	Easy-Click 60 hose connection female 60 mm for flexible hose T005 87 620 36
300-3011	Easy-Click 60 hose connection female 60 mm for flex arms with 2 rivets

Pipe system 50



T005 87 358 47	Hose connection 50 for WFE 2S, WFE 4S, ZS 4V and ZS 6V. For connection to 50 mm (1.96 in) pipe or extraction hose
T005 87 358 48	Hose connection 50, 90° for WFE 2S, WFE 4S, ZS 4V and ZS 6V. For connection to 50 mm (1.96 in) pipe or extraction hose
T005 87 353 27	Extraction hose 50 Ø 50 mm (1.96 in), for connection to pipe system 50, sold by meter
T005 87 358 79	Hose clamps 50–70 mm (1.96–2.75 in), 2 units, for securing extraction hose 50

Pipe system 75







T005 87 358 32	Hose connection 75 for WFE 2S, WFE 4S, ZS 4V, ZS 6V e.g. for connection to a stand alone system by means 75 mm (2.95 in) pipe or 75 mm (2.95 in) extraction hose. Plastic, black.
T005 87 358 33	Hose connection 75, 90° for WFE 2S, WFE 4S, ZS 4V, ZS 6V e.g. for connection to a stand alone system by means 75 mm (2.95 in) pipe or 75 mm (2.95 in) extraction hose. Plastic, black.
T005 87 353 13	Extraction hose 75 Ø 75 mm (2.95 in), for connection to pipe system 75. Sold by metre. Plastic, grey/black, flexible.
T005 87 358 31	Hose clamps 70–90 mm (2.75–3.54 in), 2 units, for securing extraction hose 75

75 mm Pipe System see page 44

Accessories Installation Volume Extraction



Order No.	Description	
T005 87 627 66	Easy-Click 60 T-piece with 2 male connections and 1 female connection	
T005 87 627 74	Easy-Click 60 end cap female, 60 mm, click connection	 ESD safe
T005 87 627 71	Adapter male, Ø 75 mm to Easy-Click 60 female	 ESD safe
FT91000015	Adapter male 75 to male 60	 ESD safe
T005 87 627 50	Adapter 40/60 for Easy-Click 60 extraction arms on 50 mm WFEMP50 power socket	 ESD safe
T005 87 627 53	50/60 Adapter with silicone O-ring to connect Easy-Click 60 mm hoses to WFE 2ES, WFE 2CS, WFE 2S, MP or MG units or 50 mm tubes	 ESD safe

Accessories

Order No.	Description
800-5001	Connection hose aluminium coated Ø 100 mm by meter (max length 6 m/pc)
800-5011-ESD	Connection hose aluminium coated Ø 160 mm by meter (max length 6 m/pc)
800-5002	Reduction 100/63 mm incl. quick connection
800-5004	Reduction 80/63 mm incl. quick connection
800-5012	Reduction 160/100 mm

Volume Extraction Accessories



Order No.

Description

T005 36 574 99

Easy-Click 60 Stop valve

Table connector for 60 mm (2.36 in) flex arm and extraction hose including air flow valve and 2 bench mounting brackets, male / male



ESD safe



T005 36 575 99

Bench mounting brackets, 2 x

Maximum width of clamp 100 mm (3.93 in), Ø 100 mm (3.93 in), metal



T005 87 627 46

Easy-Click WFV 60 A Automatic valve

including 2 bench mounting brackets, WX soldering station controlled automatic valve, male / male



ESD safe

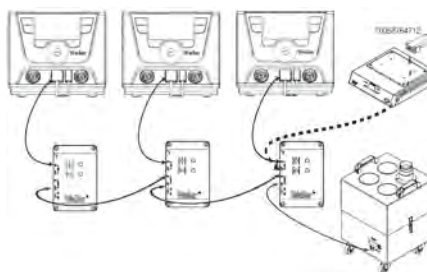

T005 87 627 65

Easy-Click WFV 60 Stop valve

male/female for extraction arms without valve



ESD safe



T005 87 628 08

Replacement butterfly valve plate

for stop valve



ESD safe



FT-W

Replacement butterfly valve

axis rod and handle



780-3001-ESD

Hanging device

for table mounting for fume extraction unit WFE 2X, MG 100, MP 140 including 2 brackets



Exhaust accessories to blow waste air out of a building

Order No.	Description
T005 87 359 20	Exhaust adapter of pipe 100 to fume extraction unit WFE 20D, ZS 20T
T005 87 358 40	Exhaust adapter of pipe 100 to fume extraction unit WFE 4S, ZS 6V
T005 87 359 15	Exhaust adapter of pipe 75 for fume extraction unit WFE 2S, ZS 4V

Remote control for tip and volume extraction units



Order No.	Description
T005 87 359 09	Remote control for fume extraction units WFE 20D, WFE 2S, WFE 4S, WFE 8S, ZS 4V, ZS 6V, ZS 20T. Switching unit on/off, speed setting (only WFE 2S, WFE 4S, ZS 4V, ZS 6V) filter status display.
T005 31 191 99	Interface cable RS 232 , 2 m (78.74 in) for remote control (T005 87 359 09)
700-3057	Remote control with cable for MG unit and WFE 2X
T005 87 627 24	Adapter remote control for ZS 4V, ZS 6V
T005 87 647 12	WX adapter for ZS 4V, ZS 6V
T005 87 647 10	Cable adapter cord for WX adapter (T005 87 647 12)
T005 87 647 26	WX HUB

Tip Extraction

Weller FE (Fume Extraction) soldering irons have a smoke tube adapted to the handle. When soldering the tube is positioned directly above the tip and collects any fumes produced. Fume extraction irons can be connected to the Weller FT 12 and WFE P / WFE2P systems (both table top units driving up to 2 irons) or ZS 20T – a mobile unit driving up to 20 irons.

A safety rest with Stop + Go function switches the extraction system on when the FE soldering iron is removed from the safety rest and off after a short delay when the iron is replaced (WFE P / WFEP2) and FT 12). Fume extraction attachments can be retro-fitted to non fume extraction Weller soldering irons.

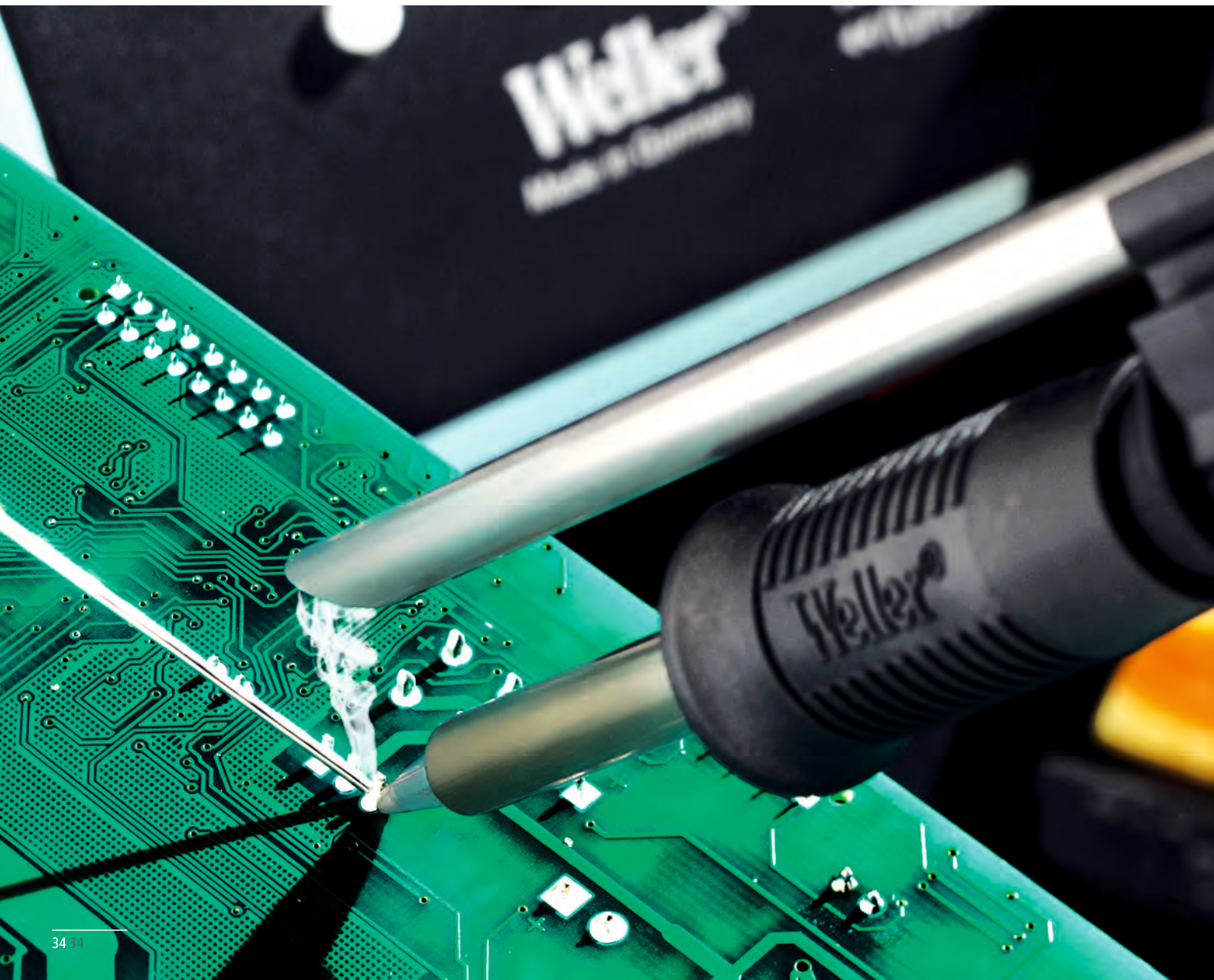

Characteristics

- > FE (Fume Extraction) soldering irons extract fumes directly at the soldering tip.
- > Less airflow and high vacuum, up to 12.000 Pa for efficient fume extraction.
- > Maximum bridging distance 200 m (656 ft.), ZS 20T requires Weller pipe system 50.
- > Filter condition warning – LED on the unit or remote control via RS 232 and PC (ZS 20T).
- > Variable electronically controlled pump speed, adjustable at the unit or by remote control via RS 232 and PC (ZS 20T).

Areas of application

- > Hand soldering



WFE P / WFE2P
up to 2 workplaces



FT 12
up to 2 workplaces



Zero Smog 20T
up to 20 workplaces

FT 12

Small, portable, compressed air driven fume extraction unit



ESD safe



low sound level

Technical Data

Maximum capacity	2 FE soldering irons
Noise level	< 37 db (A) at 1 m distance
Maximum vacuum	20.000 Pa
Operating pressure	3,5–7 bar
Air consumption	27 l/min
Height	200 mm
Diameter	120 mm
Weight	1,7 kg

Scope of supply

- > FT 12 Fume extraction unit
- > Compressed air cleaning filter
- > Compact filter consists of: Particle filter H13, Wide band gas filter (50 % active carbon, 50 % Chemisorb)
- > Fine dust filter F7

Order No. 112-0000-ESD

Spare parts & Accessories

	Order No.
Throttle valve FT 12	300-2000
Hose set FT- and FE-series	300-2001
Ejector for FT 12	300-2002



Attributes

- > Up to 2 FE soldering irons can be connected
- > Maintenance-free compressed air converter
- > Portable unit for stand alone applications
- > for industrial long term use

The fume extraction unit FT 12 requires clean and oil-free compressed air. The vacuum is generated by a maintenance-free compressed air converter. The contaminated air is purified by a pre-filter and main filter system. A compressed air cleaning filter removes additional odours caused by the compressed air. This highly efficient filter system makes the FT 12 a genuine air recovery system.

The FE (Fume Extraction) soldering irons are connected directly to the unit – additional leads are not required.

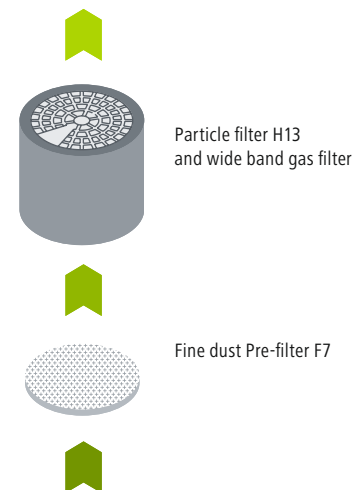

WFE P / WFE2P

Small, portable, electrically driven fume extraction unit



Attributes

- > Up to 2 FE soldering irons can be connected
- > Electric vacuum pump to produce the required vacuum
- > 2 power stages for higher extraction performance with 2 FE soldering irons
- > Portable unit for stand alone applications

The Weller WFE P is a line voltage fume extraction unit designed to run with one or two FE (Fume Extraction) soldering irons. The WFE P has an electric, long-life, soundproofed vacuum pump to produce the required vacuum – it does not need a compressed air supply. The vacuum pump has two power settings which can be selected by means of rocker switches depending on the number of FE soldering irons connected to the unit. This saves energy. The motor is maintenance-free and has a thermal over load to protect the unit. The filter lift system allows fast and convenient main filter replacement.

FE soldering irons are connected directly to the unit – additional leads are not required.



ESD safe



low sound level

Technical Data

Maximum capacity	2 FE soldering irons
Noise level	< 45 db (A) at 1 m distance
Operating voltage	230 V / 50 Hz 120 V / 60 Hz (USA)
Power input	70 W
Maximum vacuum	30.000 Pa
Height	295 mm
Diameter	140 mm
Weight	4 kg

Scope of supply

- > WFE P / WFE2P Fume extraction unit
- > Compact filter consists of: Particle filter H13 and wide band gas filter (50 % active carbon, 50 % Chemisorb)
- > Fine dust filter F7

Order No. 230 V T005 36 386 99

Order No. 120 V, WFE2P (USA) T005 36 232 99

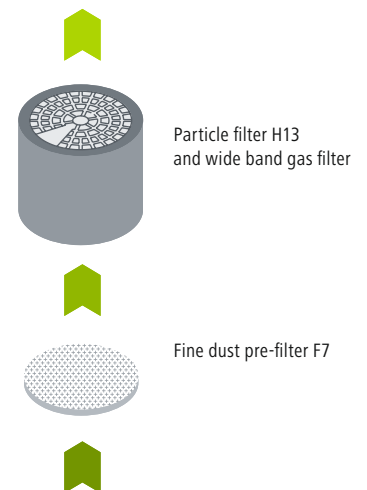

Zero Smog 20T

Mobile, powerful, electronically driven fume extraction unit



ESD safe



low sound level

Up to 6 WellerFT (Fume Extraction) soldering irons can be connected directly to the fume extraction unit ZS 20T. Using the Pipe System 50 (available as accessory) up to 20 FE soldering irons can be supported by the unit. The powerful maintenance-free turbine generates a vacuum of 10.000 Pa and is

electronically controlled. Operating hours and filter contamination level are also recorded electronically.

The filter system achieves a filtration rate of 99,95 % as per EN 1822 with a particle size of 0,16 µm.

Technical Data

Maximum capacity	20 FE soldering irons
Noise level	< 51 db (A) at 1 m distance
Operating voltage	230 V / 50 Hz, 120 V / 60 Hz
Power input	630 W
Maximum vacuum	10.000 Pa
Maximum delivery rate	100 m³/h
Dimension (L x W x H)	450 x 450 x 695 mm
Weight	45 kg

Scope of supply

- > ZS 20T Fume extraction unit
- > Compact filter consists of: Particle filter H13 and wide band gas filter (50 % active carbon, 50 % Chemisorb)
- > Fine dust filter F7

Order No. 230 V T005 36 706 99

Order No. 120 V (USA) T005 36 702 99



Attributes

- > Up to 20 FE soldering irons can be connected
- > Electric driven, maintenance free turbine produces the required vacuum
- > 4 wheels to allow easy movement of the unit
- > Mobile unit for central and stand alone applications
- > Central installation for pipe systems up to 200 m (656 ft.)

Characteristics

- > **Two operating modes:**
Mode 0: Vacuum regulated to 10.000 Pa
Mode 1: Extraction performance can be set between 20 %–100 % with the control buttons.
- > Electronic filter check (LED) through differential pressure measurement. If the specified degree of contamination is exceeded, the unit switches off.
- > Electronic filter operation status display. For better management of filter change intervals – the filter operating hours can be pre-specified. The need for filter change is indicated in good time allowing adequate time for filter procurement and replacement.
- > Interface RS 232 for remote monitoring or remote control. Remote control available as accessory.

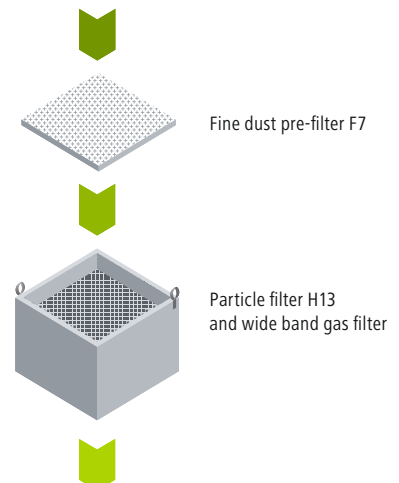



ESD safe

FE (Fume Extraction) Soldering Irons

The smoke absorption tube is integrated into the handle. It can be placed over the joint when soldering but can be retracted when access to the joint is a problem and can also be removed for cleaning. FE 75 iron is temperature controlled, ergonomic and allow precise handling. These electronically controlled iron can be driven from any Weller FE 80 W power

unit compatible with the rating of the iron or any Weller station. The range of iron power ratings and the extensive range of solder tips mean that there is an iron to suit all applications. The FE soldering irons are supplied with a burn proof hose 5 mm (0.19 in) diameter, 2,5 m (8.2 ft.) long.



Order No.	Description
T005 33 151 99	FE 75 Soldering iron set 80 W / 24 V with safety rest KH 20* for use with LT tips
T005 25 125 99	FE-attachment for Weller soldering irons LR 21, TCPS, W 61, W 101, WP 200, WXP 200, WSP 150
T005 28 126 99	FE-attachment for Weller WSF 80D5/D8 with AKS safety rest
T005 13 125 99	FE-attachment for Weller desoldering irons DS 22, DS 80 and DSX 80

Universal FE attachments



Order No.	Description
T005 29 186 99	FE-attachment with tube Ø 6,5 mm for Weller soldering irons WSP 80, WP 80, WMP, WP 120
T005 29 214 99	FE-attachment with tube Ø 6,5 mm for Weller WX soldering irons
T005 29 185 99	FE-attachment with tube Ø 4,5 mm for Weller WMRP and WSP 80, WP 80, MLR 80, WMP soldering irons, for fine soldering applications
T005 87 448 75	FE-Clip-Set for FE-attachment, tube Ø 4,5 mm
T005 87 448 76	FE-Clip-Set for FE-attachment, tube Ø 6,0 mm
T005 87 657 98	FE-attachment with tube Ø 6,5 mm, for WXP 120 soldering iron
T005 87 657 99	FE-attachment with tube Ø 6,5 mm, for WXP 65 soldering iron

* Cleaning brush for FE tubes and fume extraction funnels are included in the scope of supply of the soldering irons.

Tip Extraction Accessories

Order No.	Description
001-0043-ESD	Clip-on kit universal (model 3) for soldering irons from ERSA, Hakko, Weller, Metcal etc.
001-0044-ESD	Clip-on kit universal (model 4)
001-0051-ESD	Clip-on kit ERSA Micro tool
001-0093	Clip-on kit Weller WSP80, MLR21, MT1500, Hakko 907/912
010-2825-ESD	Spot suction nozzle for clip-on kit Metcal/Universal 1 length: 200 mm; Ø 5,0 / 4,6 mm
010-2827-ESD	Spot suction nozzle for clip-on kit ERSA Micro tool length: 140 mm; Ø 5,0 / 4,6 mm
010-2828-ESD	Spot suction nozzle clip-on kit Filtronic universal 2 & 3 length: 220 mm; Ø 5,0 / 4,6 mm
010-2833-ESD	Spot suction nozzle for clip-on kit Pace PS80/SP2A length: 220 mm; Ø 4,5 / 3,9 mm
010-2834-ESD	Spot suction nozzle for clip-on kit Weller WSP80 / MLR21 / MT1500, Hakko 907 / 912, length: 180 mm; Ø 6,3 / 5,4 mm
001-0001	E-clips , 6/8 mm
001-0014	E-clips , 4/6 mm
010-1038	On/off-tap for MG units
010-1041	Conductive silicone hose Ø 7/4,5 mm, by meter
010-1042	Conductive silicone hose Ø 8/5 mm , by meter
010-9901-ESD	Cleaning brush , 4 mm
010-9902-ESD	Cleaning brush , 5 mm



Order No.	Description
T005 36 352 99	Locking clip for extraction hose
T005 25 410 00	Extraction hose (spare) , Ø 5 mm, by meter

Accessories for workbench installations



Order No.	Description
T005 36 316 99	Extraction hose 40 , 1 m (39.37 in), Ø 40 mm (1.5 in) complete with 2 connecting elements for direct connection of unit (WFE 20D) ZS 20T to pipe system 50, plastic, grey/black, flexible
T005 36 414 00	Extraction hose 40 , Ø 40 mm (1.5 in) without connecting elements, sold by metre, plastic, grey / black, flexible
T005 36 415 99	Connecting element 40 – 50 for connecting extraction hose 40 and pipe system 50, rubber, black
T005 36 326 99	Extension hose , length 5 m (198.85 in), Ø 13 mm (0.51 in), used where the fume extraction iron is further than 2,5 m (8.2 ft.) from the pipe system 50. Note: Connection nipple (T005 87 358 65) and adapter (T005 36 343 99) will be required
T005 87 358 65	Connection nipple for extension hose 13, G 3/8"
T005 87 358 66	Nut G 3/8" for connection nipple
T005 36 343 99	Adapter 13/5 mm for connection extension hose with Ø 13 mm (0.51 in) extension hose of FE irons
T005 36 338 99	Connection nipple for Ø 5 mm (0.19 in) extraction hose to connect FE soldering irons directly to pipe system 50. The connection nipple is screwed at any point into the pipe system. (metric thread M8 x 1)
T005 87 350 50	End cap to close off to connection nipple 5 mm
T005 87 628 10	Connection adapter for ZS 20T (including 3 x end cap), 3 x 5 mm hose



Safety Rests with Stop+Go function for FE Irons with FT 12 or WFE P

The Weller safety rests with Stop+Go function are recommended accessories for FE irons using the WFE or WFE P extraction units. A fibre optic sensor switches the extraction unit on when the FE iron is removed from the safety rest and when the FE iron is replaced in the safety rest, after a short delay to gather the fumes from any solder on the tip it switches the unit off. This reduces running costs.



Order No.	Description
T005 15 086 99	KHP Basic unit pneumatic (for FT 12) safety rest with Stop+Go function with fibre optic sensor for FE 75
T005 15 076 99	KHE Basic unit electric (for WFE P) safety rest with Stop+Go function with fibre optic sensor for FE 75
T005 15 080 99	KHE/P Second safety Rest with fibre optic sensor for extending to 2 workplaces
T005 15 168 99	KHP 81 Basic unit pneumatic (for FT 12) safety rest with Stop+Go function with fibre optic sensor for WSP 80, WP 80, WP 120



Order No.	Description
T005 15 167 99	KHE 81 Basic unit electric (for WFE P) safety rest with Stop+Go function for soldering irons WSP 80, WP 80, WP 120 with fibre optic sensor



T005 15 161 72	WDH 10T OPTO Second safety rest for KHE / KHP with fibre optic sensor for extending to 2 workplaces
----------------	---



T005 15 152 99	WDH 30 Safety rest for FE 75 and LR 21, LR 82 and TCPS with FE attachment
----------------	---

Cord Support

The cord support keeps the soldering iron cord out of the direct working area. This allows easier handling of the soldering iron.



Order No.	Description
T005 15 066 99	Cord support for safety rest KH 20/23

Pipe System 50 Tip Extraction

Tip extraction systems demand a high quality, constant level of vacuum across the installation. To achieve this it is necessary to use a pipe system with a relatively small diameter. The Weller pipe system 50 allows extraction **installations of up to 200 m (656 ft.)** when used with the ZS 20T unit in a stand alone system. The pipe sections are designed to join together and have internal sealing bushes. In a central system, the FE soldering irons are connected directly to the fume extraction units.



Pipe System 70 Volume Extraction

Volume extraction systems require a large volume of air to be extracted and the level of vacuum is of lesser importance. This means that a relatively large diameter pipe system is required. If the pipe diameter is too small the flow resistance is increased and extraction capacity reduced. The pipe system 70 allows **installations up to 30 m (99,26 ft.)** with the WFE 4S used in a stand alone system. The pipe sections are designed to join together and have internal sealing bushes.

Order No. Pipe System 50	Order No. Pipe System 75	Description
T005 36 323 99	T005 87 358 70	Pipe , 2 m (78.74 in), with seal at one end, PEHD*, black
T005 36 322 99	T005 87 358 69	Right angle pipe , 90°, 0,2 m (7.87 in), with seal at one end, PEHD*, black
T005 36 344 99	T005 87 358 71	T-piece , 2 x 90°, 0,5 m (19.68 in), with 3 seals, PEHD*, black
T005 36 321 99		Branch , 2 x 45°, 0,3 m (11.81 in), with 2 seals, PEHD*, black
T005 36 319 99		Double socket , PEHD*, black
T005 36 324 99	T005 87 358 55	End seal , plastic, transparent
T005 36 329 99	T005 87 358 64	Pipe clamps for pipes , e.g. for securing to wall, plastic, grey
	T005 87 358 63	Adapter pipe system 75 to pipe system 50 with seals
	T005 87 358 56	Adapter PEHD* pipe system 75 to pipe system 50, without seals

*PEHD = Polyethylen High Density

Table top solution with WFE P

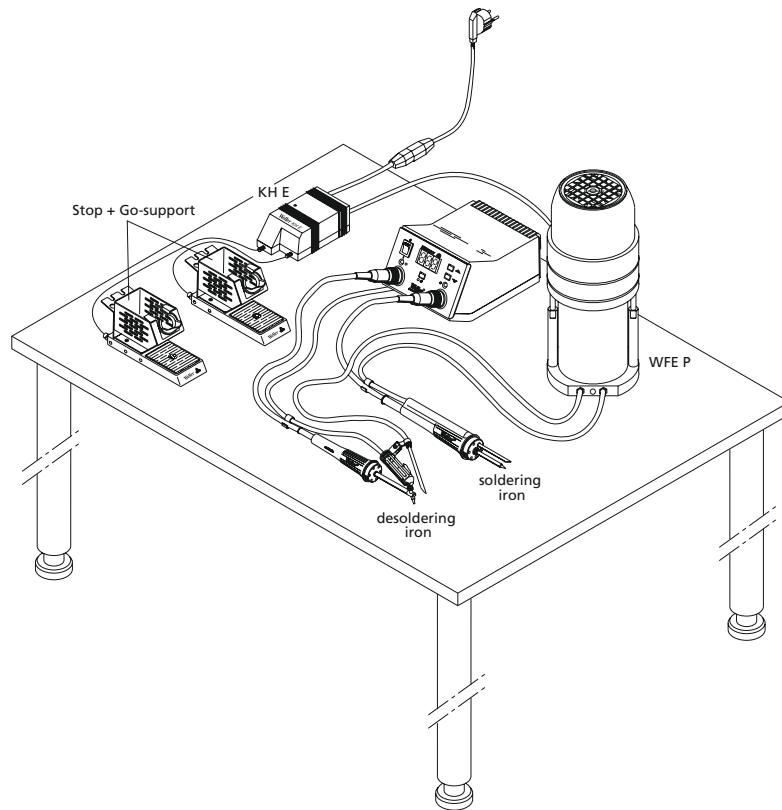

Installation option for Zero Smog 20T

decentralized system

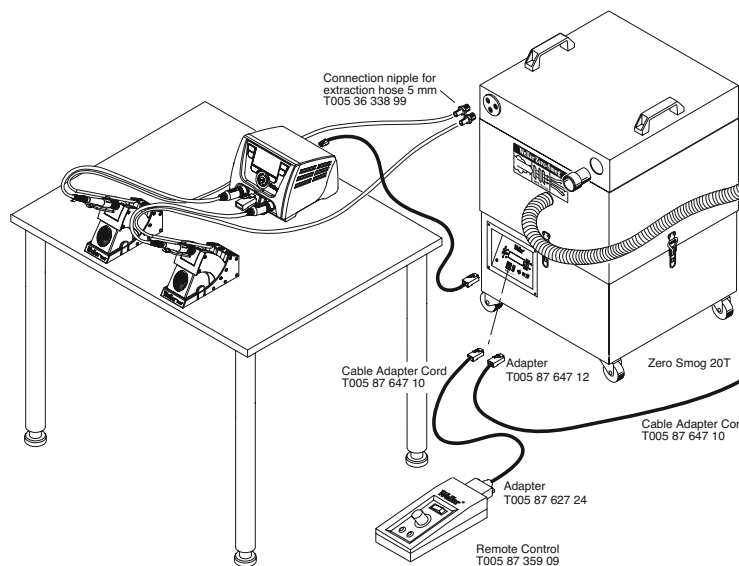

central system to about 50 m

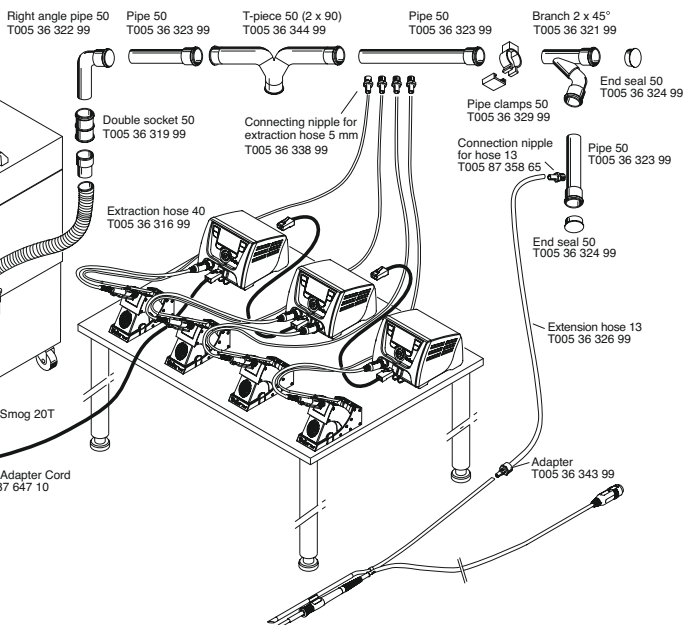

Accessories Filters

Filter Class	Recommended Application
M5	For standard applications
F7	For applications with high flux or dust content
E12 / H13	For applications with high flux or dust content
Gas	For applications with extracting adhesive fumes and solvents applications

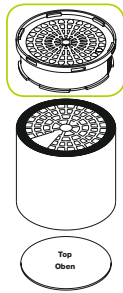

Spare Filter

Compressed air cleaning filter for WFE, WFE P, WFE2P, FT 12, FT 12-PF

Order No.	Description
T005 87 357 57	Compressed air cleaning filter (active carbon) for WFE and WFE P
210-0323-ESD	Compressed air cleaning filter (active carbon) for FT 12
210-0310	Compressed air cleaning filter (active carbon) for FT 12 (Modell 93)

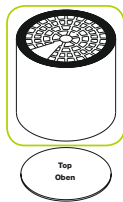

Compact filter for WFE, WFE P, WFE2P, FE 4000, FT 11, FT 12

Order No.	Description
T005 36 410 99	Particle filter H13 and wide band gas filter (50 % active carbon / 50 % Chemisorb)
212-5001-ESD	Main filter FT 12-PF

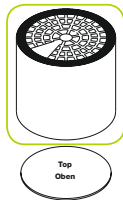

Compact filter for adhesive fumes, WFE, WFE P, WFE2P, FE 4000, FT 11, FT 12

Order No.	Description
T005 36 407 99	Adhesive filter (active carbon)
212-4012-ESD	Main filter FE 3000

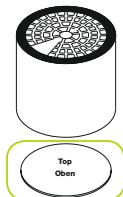

Fine dust filter F7 for WFE, WFE P, WFE2P, FE 4000, FE 3000, FT 11, FT 12, FT 12-PF

Order No.	Description
T005 36 421 99	Fine dust filter F7 (3 pcs)



FT 1

Order No.	Description
210-0323-ESD	Top filter FT 1
211-0011-ESD	Main filter FT 1
210-0315	Filter discs FT 1 (pink, 10 pcs)

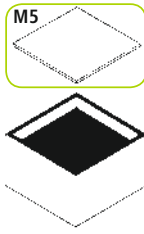

Medium dust filter M5

Order No.	Description
T005 87 358 37	Medium dust filter M5 for ZS 20T / WFE 20D, FC 800 and ZS 6V / WFE 4S, 10 pcs
T005 87 359 37	Medium dust filter M5 for WFE 2S, ZS 4V, 10 pcs
T005 87 627 03	Medium dust filter M5 for WFE 2ES / CS, ZS 2, 10 pcs

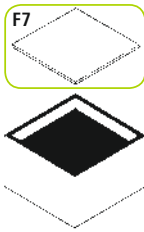

Fine dust filter F7

Order No.	Description
T005 87 358 36	Fine dust filter F7 for ZS 20T / WFE 20D, FC 800 and ZS 6V / WFE 4S, 10 pcs
T005 87 359 38	Fine dust filter F7 for WFE 2S and ZS 4V, 10 pcs

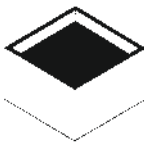

Compact filter

Order No.	Description
T005 87 358 38	Compact filter for ZS 6V / WFE 4S, ZS 20T / WFE 20D and FC 800 Particle filter H13 and wide band gas filter (50% active carbon, 50% Chemisorb)
T005 87 359 36	Compact filter for ZS 4V, WFE 2S Particle filter H13 and wide band gas filter (50% active carbon, 50% Chemisorb)

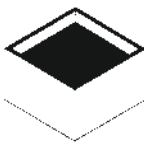

Adhesive fume filter

Order No.	Description
T005 87 358 35	Wide band gas filter for ZS 6V / WFE 4S, FC 800 (50% active carbon, 50% Chemisorb)

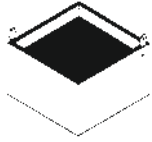

Adhesive fume filter

Order No.	Description
T005 87 358 95	Wide Band Gas Filter for ZS 4V,WFE 2S, WFE 2ES (50 % active carbon, 50 % Chemisorb)

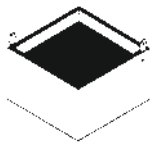

Filterset E12 for WFE 2ES / CS, ZS 2

Order No.	Description
T005 87 627 01	Filterset E12 with 10 pre-filter M5, particle filter E12 and wide band gas filter (10 % active carbon)



Pocket filter F7

Order No.	Description
T005 87 358 60	Pocket filter F7 for applications with a high fine dust rate, for pre-filter box, WFE 2S / WFE 4S, ZS 4V / ZS 6V

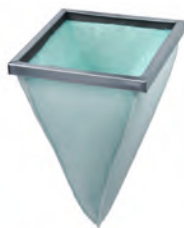

Pocket filter

Order No.	Description
T005 87 359 24	Filtering fine dust for sticky particles (e.g. large quantities of liquid flux) for pre-filter box, WFE 2S / WFE 4S, ZS 4V / ZS 6V

Filter Class	Recommended Application
M5	For standard applications
F7	For applications with high flux or dust content
E12 / H13	For applications with high flux or dust content
Gas	For applications with extracting adhesive fumes and solvents applications

How to change a WellerFT filter?
See the movie on www.youtube.com/wellersoldering



Replacement filters for MG filter systems

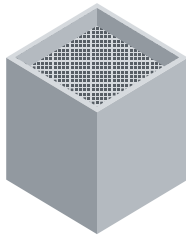

MG 140

Order No.	Description
145-2000-ESD	Particle filter H13 and gas filter MG 140, Standard
145-2002-ESD	Particle filter H13 and gas filter MG 140, Cleanroom
145-2012-ESD	Particle filter H13 and gas filter MG 140, Solvents / VOC
145-2003-ESD	Particle filter H13 and gas filter MG 140, MEK

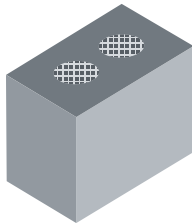

MG 100 / MG 100S / MG 80S

Order No.	Description
100-2000-ESD	Particle filter H13 and gas filter MG 100 and WFE 2 x, Standard
100-2003-ESD	Particle filter H13 and gas filter MG 100 and WFE 2 x, MEK
100-2012-ESD	Particle filter H13 and gas filter MG 100 and WFE 2 x, Solvents / VOC

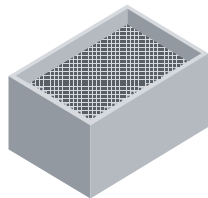

MG 130 / Tiger

Order No.	Description
130-2000-ESD	Particle filter H13 and gas filter MG 130, standard

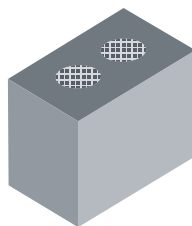

MG 200 / MG 400

Order No.	Description
200-2000-ESD	Particle filter H13 and gas filter MG 200, Standard, (2 pcs)
200-2002-ESD	Particle filter H13 and gas filter MG 200, Cleanroom, (2 pcs)
200-2003-ESD	Particle filter H13 and gas filter MG 200, MEK, (2 pcs)
200-2012-ESD	Particle filter H13 and gas filter MG 200, Solvents / VOC, (2 pcs)

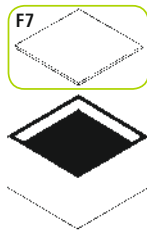

Pre-filter MG-series

Order No.	Description
145-4000	Pre-filter MG 140 / F8 (2 pcs)
200-4000	Pre-filter MG 200 / F8 (1 pcs)
450-2000	Pre-filter MG 400 / F8 (2 pcs)
130-2010	Pre-filter MG 130 (5 pcs)

FT 13

Order No.	Description
210-0323-ESD	Top filter FT 13
210-0310	Top filter FT 13 (model 93)
T0053642199	Filter discs FT 13 (3 pcs)

MP 140

Order No.	Description
140-2000-ESD	Particle filter E12 MG 140

Pre-filter for MP 140 / MG 100

Order No.	Description
PF-1000	Pre-filter box for MP 140 / MG 100 Is delivered with brackets and 2 m connection hose
500-4000	Pre-filter bags (5 pcs) for PF-1000

CBC-R

Order No.	Description
F01	Replacement filter CBC-R

Filter Class	Recommended Application
M5	For standard applications
F7	For applications with high flux or dust content
E12 / H13	For applications with high flux or dust content
Gas	For applications with extracting adhesive fumes and solvents applications

How to change a WellerFT filter?
See the movie on www.youtube.com/wellersoldering



Replacement filters for discontinued MG filter systems

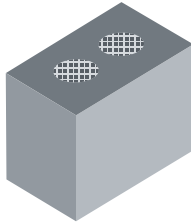

MG 75

Order No.	Description
750-2000-ESD	Particle filter H13 and gas filter MG 75, Standard
750-2002-ESD	Particle filter H13 and gas filter MG 75, Cleanroom
750-2003-ESD	Particle filter H13 and gas filter MG 75, MEK

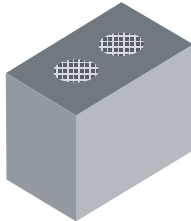

MG 95

Order No.	Description
950-2000-ESD	Particle filter H13 and gas filter filter MG 95, Standard
950-2002-ESD	Particle filter H13 and gas filter MG 95, Cleanroom
950-2003-ESD	Particle filter H13 and gas filter MG 95, MEK



BT 75

Order No.	Description
500-4000	Pre-filter BT 75 (5 pcs)



Pre-filters MG-series

Order No.	Description
750-4100	Replacement filter for pre-filter MG 75 / MG 95 (5 pcs)

GERMANY

Weller Tools GmbH
Carl-Benz-Straße 2
74354 Besigheim

Tel: +49 (0)7143 580-0
Fax: +49 (0)7143 580-108

GREAT BRITAIN

Apex Tool Group (UK Operations) Ltd
4th Floor Pennine House
Washington, Tyne & Wear
NE37 1LY

Tel: +44 (0) 191 419 7700
Fax: +44 (0) 191 417 9421

FRANCE

Apex Tool Group S.N.C.
25 Avenue Maurice Chevalier B.P. 46
77832 Ozoir-la-Ferrière Cedex

Tel: +33 (0) 1.64.43.22.00
Fax: +33 (0) 1.64.43.21.62

ITALY

Apex Tool S.r.l.
Viale Europa 80
20090 Cusago (MI)

Tel: +39 (02)9033101
Fax: +39 (02)90394231

SWEDEN

Apex Tool Group AB
William Gibsons Väg 1C
43376 Jonsered

Tel: +46 (0) 31-725 6430

CHINA

Apex Tool Group
A-8 building
No. 38 Dongsheng Road
Heqing Industrial Park, Pudong
Shanghai PRC 201201

Tel: +86 (21)60880288
Fax: +86 (21)60880289

INDIA

Apex Tool Group India Pvt. Ltd.
Regus business centre,
Level 2, Elegance, Room no. 214,
Mathura Road, Jasola,
New Delhi - 110025
India

USA

Apex Tool Group, LLC
1000 Lufkin Road
Apex, NC 27539-8160

Tel: +1 (866)498-0484
Fax: +1 (919)387-2639

CANADA

Apex Tools – Canada
7631 Bath Road
Mississauga
Ontario, L4T 3T1

Tel: +1 (905) 455 5200

AUSTRALIA

Apex Tools
P.O. Box 366
519 Nurigong Street
Albury, N.S.W. 2640
Australia

Tel: +61 (2)6058-0300
Fax: +61 (2)6021-7403

SOUTH EAST ASIA

Apex Power Tools India Pvt Ltd
Gala No. 1, Plot No. 5
S.No. 234, 235 & 245
India land Global Industrial Park.
(Next to Tata Johnson Control)
Taluka-Mulsi, Phase –I
Hinjawadi Pune (411057)
Maharashtra, India

toolsindia@apextoolgroup.com

Weller[®]FT
FILTER SYSTEMS