

RO3103

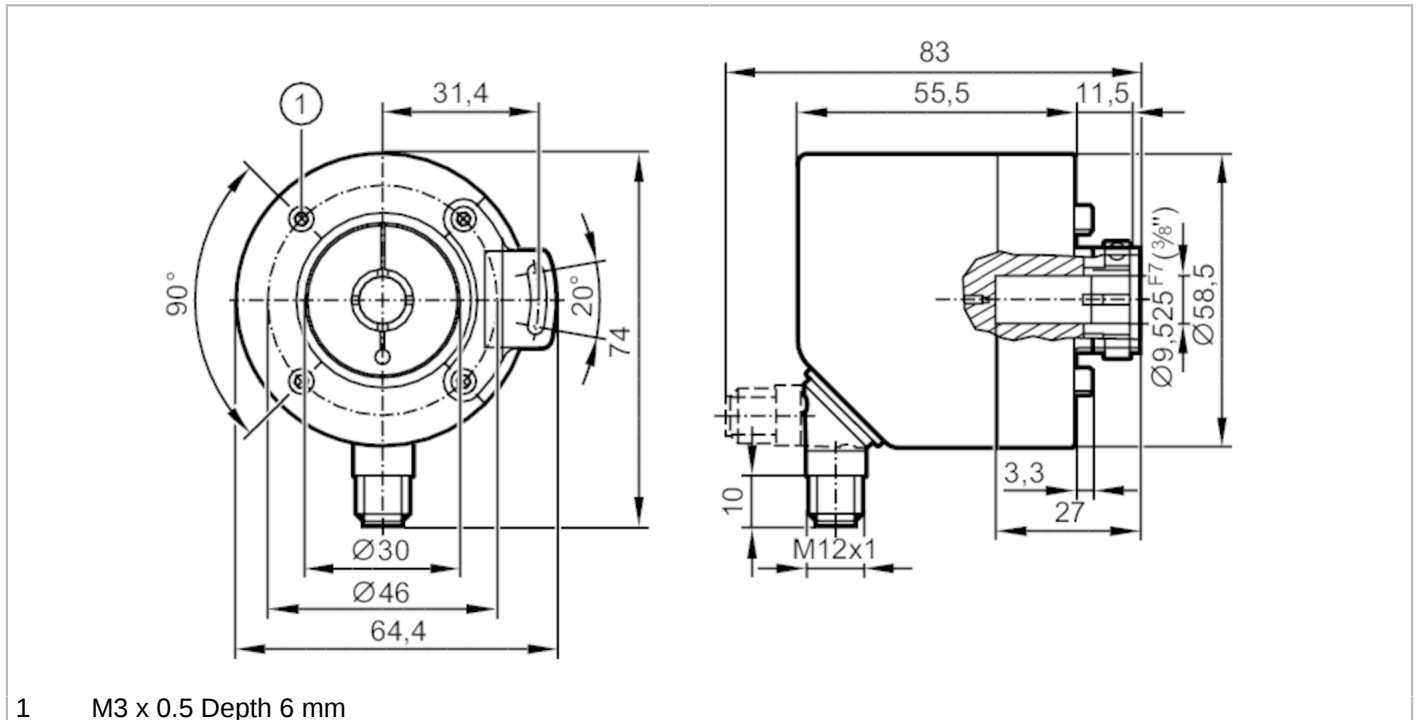

Incremental encoder with hollow shaft

INCREMENTAL ENCODER BASIC LINE



Product characteristics	
Resolution	1...10000; (parameterisable; Factory setting: 1024) resolution
Communication interface	IO-Link
Shaft design	hollow shaft open to one side
Shaft diameter [mm]	9.525
Application	
Function principle	incremental
Detection system	magnetic
Electrical data	
Operating voltage [V]	4.75...30 DC
Current consumption [mA]	< 150
Protection class	III
Reverse polarity protection	yes
Power-on delay time [s]	0.5
Max. revolution electrical [U/min]	12000
Outputs	
Electrical design	HTL/TTL
Switching frequency [kHz]	1000
Factory setting	Output function: HTL (50 mA)
Short-circuit protection	yes
Phase difference A and B [°]	90
Measuring/setting range	
Resolution	1...10000; (parameterisable; Factory setting: 1024) resolution



Incremental encoder with hollow shaft

INCREMENTAL ENCODER BASIC LINE

Accuracy / deviations	
Accuracy	[°] 0.1
Software / programming	
Parameter setting options	Resolution; direction of rotation; HTL; TTL
Interfaces	
Communication interface	IO-Link
Transmission type	COM 2
IO-Link revision	1.1
SIO mode	yes
Min. process cycle time	[ms] 2.3
Operating conditions	
Ambient temperature	[°C] -40...85
Storage temperature	[°C] -40...85
Max. relative air humidity	[%] 95; (condensation not permissible)
Protection	IP 65; IP 66; (IP 67: on the housing; IP 65: on the shaft)
Tests / approvals	
Shock resistance	100 g
Vibration resistance	20 g
MTTF	[years] 292
Mechanical data	
Weight	[g] 435
Dimensions	[mm] Ø 58.5 / L = 69
Materials	flange: aluminium; housing: stainless steel (1.4521 / 444); plug: stainless steel (1.4401 / 316)
Tightening torque	[Nm] < 0.7; (Mounting screw)
Max. revolution, mechanical	[U/min] 12000
Max. starting torque	[Nm] 2
Reference temperature torque	[°C] 20
Shaft design	hollow shaft open to one side
Shaft diameter	[mm] 9.525
Shaft material	stainless steel
Installation depth of shaft	[mm] 27
Max. axial shaft misalignment	[mm] 0,5
Electrical connection	
IO-Link	
1	L+
2	not to be used
3	L-
4	IO-Link
5	not to be used
Screen	plug

RO3103



Incremental encoder with hollow shaft

INCREMENTAL ENCODER BASIC LINE

encoder

1	UB
2	A
3	GND
4	Z/0-Pulse (90 deg)
5	B
Screen	plug

Connector: 1 x M12, radial, can also be used axially; Moulded body: stainless steel (1.4401 / 316); Maximum cable length: 100 m; (IO-Link: max. 20 m)

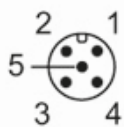

Diagrams and graphs

Pulse diagram

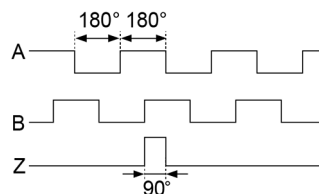

direction of rotation clockwise (looking at the shaft)